

**DRAINAGE REPORT
FOR THE**

**11TH CONCESSION
DRAIN BRANCH**

**IN THE
TOWN OF TECUMSEH**



(FINAL-COUNCIL CONSIDERATION)

7 FEBRUARY 2023

MARK D. HERNANDEZ, P. ENG.

FILE No. 22-3557

TECUMSEH FILE NO. E09EL(35)

File No. 22-3557

Mayor and Council
The Corporation of the Town of Tecumseh
917 Lesperance Road
Tecumseh, Ontario
N8N 1W9



**Drainage Report for the
11TH CONCESSION DRAIN BRANCH
In the
Town of Tecumseh**

Mayor and Council:

Instructions

The Municipality received a petition for a new municipal drain from a landowner (Roll No. 560-03511) within Lot 19, Concession 10 dated 22 November 2021. Council accepted the petition under Section 4 of the Drainage Act and on 12 January 2022 appointed Dillon Consulting Limited to prepare a report.

Area Requiring Drainage

We determined the area requiring drainage as being described as the lands within the watershed in part Lot 19, Concession 10 bounded by County Road No. 42, County Road No. 43 (11th Concession Road) and the future right-of-way for County Road No. 43. These lands are residential properties.

Validity of Petition

The petitioner's lands (Roll No. 560-03511) that are within the area requiring drainage have an area of 0.47 hectares (1.17 acres) representing 100% of the area requiring drainage. Accordingly, pursuant to Section 4(1)(b) of the Drainage Act, we have determined the petition to be valid as the petitioner representing Roll No. 560-03511 occupies more than 60% of the lands within the area requiring drainage.

Drain History

The recent history of Engineers' reports for the 11th Concession Drain follows:

- **10 February 2014 by Mark D. Hernandez, P.Eng.:** The report recommended the incorporation of a private access culvert as part of the 11th Concession Drain.
- **13 April 2006 by Tim R. Oliver, P.Eng.:** The report recommended the installation of a secondary access bridge for Roll No. 560-05400.
- **4 April 2000 by Lou Zarlenga, P.Eng.:** The report recommended a new farm access culvert and enclosure for Roll No. 560-04100. This report is an addendum Drainage Report No. 2.
- **25 September 1998 by Lou Zarlenga, P.Eng.:** The report recommended the repair and improvement including widening and deepening of the open drain and the lowering and replacement of multiple access culverts.
- **16 September 1976 by Maurice Armstrong, P.Eng.:** The recommended work included the cleaning of the entire 11th Concession Drain.

3200 Deziel Drive
Suite 608
Windsor, Ontario
Canada
N8W 5K8
Telephone
519.948.5000
Fax
519.948.5054

On-Site Meeting

We conducted an on-site meeting on 28th February 2022. A record of the meeting is provided in Schedule 'A', which is appended hereto.

Survey

The survey was completed in 2019 as part of the detailed design assignment for the County Road No. 42 reconstruction and County Road No. 43 (Banwell Road) realignment.

Background

As part of the future County Road No. 42 reconstruction, the 11th Concession Drain along County Road No. 42 will be filled in and abandoned and a new outlet for the 11th Concession Drain into the future County Road No. 42 Drain will be constructed. This report specifically covers the construction work for the proposed new branch drain along the west side of the 11th Concession Road. It shall have its outlet into the 11th Concession Drain. The said drainage works shall follow the construction of the County Road No. 42 Drain.

Video inspection of the existing sewers along the west side of the 11th Concession found that the existing upstream HDPE pipe portion is in good condition while the existing downstream CSP pipe portion is in very poor condition.

The new drain shall consist of the following:

- 111 m of existing 375 mm diameter HDPE pipe along the westerly side of County Road No. 43 (11th Concession Road) right-of-way.
- 95 m of 375 mm diameter HDPE pipe along the westerly side of County Road No. 43 (11th Concession Road) right-of-way.
- Four (4) – 750 mm diameter HDPE catch basins complete with cast iron grates.
- 15 m of 375 mm diameter PVC pipe between existing manholes STMH 42 and STMH 41 installed by others.
- One (1) – 600 mm x 600 mm precast concrete catch basin (CB1) complete with frame and grate installed by others.
- 8.0 m of 250 mm diameter PVC DR-35 pipe between CB1 and manhole STMH 42.

The St. Louis Drain located within the County Road No. 42 corridor will be abandoned under a separate report.

Design Considerations

The existing residential properties and the existence of utilities and services on the west side of the road preclude the construction of an open drain. The condition of the existing corrugated steel pipe was captured by camera and found to be in poor condition. Therefore, it is apparent that consideration be given to the construction of a new covered drain with drainage inlets to permit entry of surface runoff and to provide landowners the opportunity to make private connections to the drain. It was determined that drainage must be provided that not only effectively collects the runoff from the road and private properties, but also conveys this runoff to a sufficient outlet.

The soils are predominantly poorly drained Brookston Clay. The drain has been designed to convey a 1:5 year design storm which is generally acceptable for suburban areas.

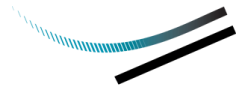

We believe that these design standards should provide a reasonable level of service, but it should be clearly understood that runoff generated from large storms or fast snow melts may sometimes exceed the capacity of the proposed systems and result in surface ponding for short periods of time.

With respect to Excess Soils Legislation, a borehole was completed along the alignment of the proposed pipe replacement. The lab results meet Table 1 ESQS, with the exception of salt based parameters. This will have to be considered for excess soil generated from construction that will be removed from the site.

Allowances

In accordance with Sections 29 and 30 of the Drainage Act, we do not anticipate any lands being damaged or taken as a result of the proposed drainage works. Any residential properties and grassed areas shall be restored to original conditions as part of the work. Section 31 allowances have not been provided for the incorporation of the existing enclosed roadside drain on the west side of the 11th Concession Road, since it is believed to have been previously enclosed for the benefit of residential properties that have been or will be developed adjacent to the road. Therefore, 'Schedule B' for Allowances has not been included.

Recommendations and Cost Estimate

A new future covered drain in the form of a storm sewer constructed along the south side of County Road No. 42 from the west limit of the Town of Tecumseh municipal boundary to Pike Creek in the Town of Lakeshore will replace the 11th Concession Drain along County Road No. 42. The portion of the 11th Concession Drain along the easterly limit of County Road No. 43 (11th Concession Road) will be realigned at the intersection with the construction of a new storm sewer and outlet directly into the future County Road No. 42 Drain.

We recommend the existing upstream portion of 375 mm diameter HDPE tile drain including catch basins along the westerly limit of County Road No. 43 as well as the 375 mm diameter PVC between STMH41 and STMH42 be known as 11th Concession Drain Branch. The downstream section of the existing corrugated steel tile drain shall be replaced with 375 mm diameter HDPE pipe including new catch basins and shall also form part of the 11th Concession Drain Branch. The new drain shall flow into the existing STMH42 then flow easterly across County Road No. 43 (11th Concession Road) right-of-way and outlet into the existing STMH41 of 11th Concession Drain. It will serve an overall watershed area of 1.29 hectares (3.23 acres).

Based on our review of the history, the information obtained during the site meeting and our examination and analysis of the survey data, we recommend the new drain be known as the 11th Concession Drain Branch and installed on the westerly side of County Road No. 43 (11th Concession Road) in approximately the same location as the existing tile. We recommend the work to be completed as described below:

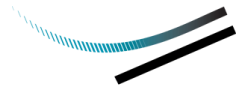



Item	Description	Amount
	<u>TILE DRAIN WORK</u>	
1.	Tile drain installation as follows:	
	<p>a) Station 0+015 to Station 0+110 – Supply and install 95 metres of new 375 mm diameter solid (non-perforated) corrugated high density polyethylene (HDPE) smooth wall 320 kPa pipe (Boss 2000 or approved equal) with split coupler joints. Pipe installation is to include clearstone (minimum 150 mm thickness under pipe) bedding (approximately 35 tonnes), Granular ‘B’ up to pipe springline (approximately 40 tonnes) except under existing driveways where full Granular ‘B’ backfill (approximately 55 tonnes) is required with filter fabric wrapping (minimum 1 metre wide) over pipe joints, and native backfill beyond (approximately 50 m³). Work to include connection to STMH42 and connection of private storm drains where encountered. Removal and disposal of existing pipe and backfill materials off-site that is not suitable for native backfill. The work will include compaction of all backfill, placement of salvaged topsoil and regrading as specified. This work is to include the stripping of topsoil from the working corridor area prior to trench excavation, to be temporarily stockpiled and then restored following drain installation. Excavated topsoil and fill materials shall be stockpiled separately. Any existing tile and/or debris that may be unearthed throughout the trenching process and all excess materials to be disposed of, off-site.</p> <p><i>Note: Existing backfill materials from the existing tile may be used where native backfill is specified provided no broken concrete, steel or other deleterious materials are used for this purpose. Where there is an insufficient amount of native fill materials for backfilling the culvert, the Contractor may elect to import additional fill materials or alternatively use Granular ‘B’ at his/her own expense. Any excess materials shall be disposed of off-site. Excess soils meet Table 1 ESQS with the exception of salt based parameters.</i></p>	\$20,000.00



Item	Description	Amount
	<p>b) Station 0+000B to Station 0+008B – Supply and install 8 metres of new 250 mm diameter PVC DR-35 pipe between existing CB1 and STMH42. Pipe installation is to include clearstone (minimum 150 mm thickness under pipe) bedding (approximately 5 tonnes), Granular ‘B’ up to pipe springline (approximately 2 tonnes) except under existing driveways where full Granular ‘B’ backfill (approximately 5 tonnes) is required with filter fabric wrapping (minimum 1 metre wide) over pipe joints, and native backfill beyond (approximately 5 m³). Removal and disposal of existing pipe and backfill materials off-site that is not suitable for native backfill. The work will include compaction of all backfill, placement of salvaged topsoil and regrading as specified. This work is to include the stripping of topsoil from the working corridor area prior to trench excavation, to be temporarily stockpiled and then restored following drain installation. Excavated topsoil and fill materials shall be stockpiled separately. Any existing tile and/or debris that may be unearthed throughout the trenching process and all excess materials to be disposed of, off-site.</p> <p><i>Note: Existing backfill materials from the existing tile may be used where native backfill is specified provided no broken concrete, steel or other deleterious materials are used for this purpose. Where there is an insufficient amount of native fill materials for backfilling the culvert, the Contractor may elect to import additional fill materials or alternatively use Granular ‘B’ at his/her own expense. Any excess materials shall be disposed of off-site. Excess soils meet Table 1 ESQS with the exception of salt based parameters.</i></p>	\$2,800.00
2.	Remove and dispose of existing four (4) catch basins.	\$2,000.00
3.	Supply and installation of four (4) new 750 mm diameter solid corrugated high density polyethylene (HDPE) smooth wall (Boss 2000 or approved equal) catch basins (denoted as CB on drawings) complete with cast iron grate and a minimum 300 mm deep sump. Work is to include connection of all new drain pipes and grouting all voids around pipes with non-shrink concrete grout and fine grading and seeding in disturbed areas.	\$7,400.00
4.	Driveway restoration as follows:	
	<p>a) Driveway restoration with gravel surface at Station 0+004B. Supply, placement and compact Granular ‘A’ (crushed limestone) driveway surface, minimum 200 mm thickness (approximately 5 tonnes) matching existing driveable top widths and surface elevations.</p>	\$200.00

Item	Description	Amount
	b) Driveway restoration with concrete surface at Station 0+015. Supply and placement of 150 mm thickness of 30 MPa concrete (approximately 1 m ³) match existing driveable top widths and existing surface elevations.	\$1,200.00
	c) Driveway restoration with concrete surface at Station 0+048. Supply and placement of 150 mm thickness of 30 MPa concrete (approximately 1 m ³) match existing driveable top widths and existing surface elevations.	\$1,200.00
	d) Driveway restoration with concrete surface at Station 0+057. Supply and placement of 150 mm thickness of 30 MPa concrete (approximately 1 m ³) match existing driveable top widths and existing surface elevations.	\$1,200.00
	e) Driveway restoration with interlocking brick surface at Station 0+078. Salvage and reinstallation of salvaged interlocking brick. Match existing driveable top widths and surface elevations. <i>Landowner may elect to perform this work.</i>	\$2,500.00
5.	Station 0+015 to Station 0+132 – Regrading and seeding of disturbed grassed areas including placement of topsoil (minimum 100 mm layer) on west side of County Road No. 43 (11 th Concession Road)(approximately 120 m ²)	\$2,000.00
6.	Temporary silt control measures during construction	\$800.00
	SUB-TOTAL – EXCLUDING SECTION 26 COSTS	\$41,300.00
7.	Survey, Report, Assessment and Final Inspection (cost portion)	\$24,900.00
8.	Expenses and incidentals (cost portion)	\$1,500.00
9.	ERCA application, review and permit fee	\$800.00
	TOTAL ESTIMATE – 11TH CONCESSION DRAIN BRANCH (excluding Net HST)	\$68,500.00

The estimate provided in this report was prepared according to current materials and installation prices as of the date of this report. In the event of delays from the time of filing of the report by the Engineer to the time of tendering the work, it is understood that the estimate of cost is subject to inflation. The rate of inflation shall be calculated using the Consumer Price Index applied to the cost of construction from the date of the report to the date of tendering.

Should the Road Authority elect to construct the drainage works across their road right-of-ways (Section 26.0 increased cost items) with their own forces, as per Section 69 of the Drainage Act, R.S.O., 1990, the Road Authority shall remain responsible for their allotment of costs for the preparation of this report as outlined in our estimate. Should the Road Authority elect not to undertake this work, the work items, as noted under Section 26 above, should be kept separate when tendering out the entire drainage works.

Assessment of Costs

The individual assessments are comprised of three (3) assessment components:

- i. Benefit (*advantages relating to the betterment of lands, roads, buildings, or other structures resulting from the improvement to the drain*).
- ii. Outlet Liability (*part of cost required to provide outlet for lands and roads*).
- iii. Special Benefit (*additional work or feature that may not affect function of the drain*).

We have assessed the estimated costs against the affected lands and roads as listed in Schedule 'C' under "Value of Special Benefit," "Value of Benefit" and "Value of Outlet." Details of the Value of Special Benefit listed in Schedule 'C' are provided in Schedule 'D.'

Assessment Rationale

Special Benefit assessment shown in Schedule 'C' and detailed in Schedule 'D' were derived as follows:

1. Private drain connection costs to the 11th Concession Drain Branch shall be assessed 100% to the adjoining property as a non-proratable assessment.
2. Asphalt, concrete and interlocking brick driveway restoration costs associated with the 11th Concession Drain Branch shall be assessed 100% to the adjoining property as a non-proratable assessment.
3. 50% of the costs (excluding Special Benefit assessments) for the 11th Concession Drain Branch to be assessed as Benefit and Outlet assessment against the lands within the watershed area as a pro-ratable assessment.
4. The remaining 50% of the costs (excluding Special Benefit assessments) to be assessed as a Benefit and Outlet assessment to the County of Essex Road Authority.
5. The above estimated costs have been assessed 60% as a Benefit assessment and 40% as an Outlet assessment against all upstream lands and roads within the drainage area.

While the existing enclosed drain tile is within the road right of way and does serve a portion of the road, it is clear that this enclosure is in place for the benefit of the adjacent residential properties. Without the presence of the residential properties, the covered drain would be an open drain.

Utilities

It may become necessary to temporarily or permanently relocate utilities that may conflict with the construction recommended under this report. In accordance with Section 26 of the Drainage Act, we assess any relocation cost against the public utility having jurisdiction. Under Section 69 of the Drainage Act, the public utility is at liberty to do the work with its own forces, but if it should not exercise this option within a reasonable time, the Municipality will arrange to have this work completed and the costs will be charged to the appropriate public utility.

Future Maintenance (Enclosed Drain)

We recommend that future work of repair and maintenance of the 11th Concession Drain Branch be carried out by the Municipality and the costs assessed against the affected lands and roads as described below. The Schedule of Assessment has been developed on the basis of an arbitrary cost of \$10,000.00.

1. All work shall be assessed 100% against the lands and roads listed in Schedule 'E' in the same relative proportions as the amounts listed under "Value of Benefit" and "Value of Outlet."

These provisions for maintenance are subject to any other variations that may be made under the authority of the Drainage Act.

Approvals

The construction and/or improvement to a drainage works, including repair and maintenance activities, and all operations connected therewith are subject to the approval, inspection, by-laws and regulations of all Municipal, Provincial, Federal and other authorities having jurisdiction in respect to any matters embraced by the proposed works. Prior to any construction or maintenance works, the Municipality or proponent designated on the Municipality's behalf shall obtain all required approvals/permits and confirm any construction limitations including timing windows, mitigation/off-setting measures, standard practices or any other limitations related to in-stream works.

Drawings and Specifications

Attached to this report is "Schedule F," which contains specifications setting out the details of the recommended works, and "Schedule G," which represents the following drawings that are also attached to this report:

- Page 1 of 3: Watershed Plan**
- Page 2 of 3: Profile**
- Page 3 of 3: Details**

Grants

In accordance with the provisions of Sections 85, 86 and 87 of the Drainage Act, a grant in the amount of 33-1/3 percent of the assessment eligible for a grant may be made in respect to the assessment made under this report upon privately owned lands used for agricultural purposes. The assessments levied against privately owned agricultural land must also satisfy all other eligibility criteria set out in the Agricultural Drainage Infrastructure Program policies. In this particular circumstance, the entire cost of the work will be levied against the County of Essex and therefore, none of the assessed cost is eligible for a grant from the Ministry of Agriculture Food and Rural Affairs.

Respectfully submitted,

DILLON CONSULTING LIMITED

Mark D. Hernandez, P.Eng.
MDH:wlb



Meeting Minutes - Schedule A

Subject: S4 Petition for New Drain – 11th Concession
Date: February 28, 2022
Location: Virtual Call
Our File: 22-3557
Distribution: Distribution

Attendees

Sam Paglia	Town of Tecumseh
Mark Hernandez	Dillon Consulting Limited
Mark Fishleigh	County of Essex
Laurentiu & Luminita Vasu	Landowner 3421 11 th Concession Road
Danny Azar	Landowner 3425 11 th Concession Road

Notes

Item	Discussion	Action by
1.	A Section 4 petition signed by Azar for four (4) properties, who wants to develop lands and provide connections for 3423, 3427 and 3429. Showed map and discussed validity. Valid as it is required only for those properties. Mr. Azar declined to remove his name from the petition.	
2.	Although there is an existing storm sewer now, it needs to be incorporated as a municipal drain. It then becomes owned by and the responsibility of, the community of landowners. Need to ensure it is in good working order prior to being assumed by the landowners.	
3.	Sewers were flushed and captured by video. From the upstream side of 3421 to County Road No. 42, the pipe is CSP and is in very poor condition and required replacement. Upstream of 3421, the pipe is HDPE and is in adequate condition and does not require work at this time.	
4.	It is understood that the pipes are on County land and would be the County's property. This is what will be assumed in the absence of any other documentation to the contrary. The County was asked to confirm if they have any agreements on file.	
5.	Discussion regarding Section 31 allowances-Compensation for current value of the pipe to the current owner.	
6.	For the CSP, the pipe will have to be replaced by the owner. It has no current value and so Section 31 allowances do not apply.	
7.	For the HDPE, no work is anticipated at this time. The Section 31 allowances will be calculated and reflected in the report. How the allowances are distributed will depend on who owns the pipe.	
8.	The Town noted that the homes are connected to the pipe currently. The pipe will be on County right-of-way but the Municipal Drain will be the Town's responsibility under the Provincial Act. Homeowners will pay for future	

Item	Discussion	Action by
	maintenance work based on the future maintenance schedule.	
9.	Discussion regarding statute law vs common law. County has said they will not accept drainage from private lands and so the private lands require statute outlet.	
10.	The owners of 3421 11 th Concession Road had the following questions:	
10.1.	What future costs will there be?	
10.1.1.	The new pipe will likely be HDPE which will last a long time and so only regular flushing is anticipated and this is not expensive work. They note it is anticipated to pay for the capital works on the future maintenance costs. The future maintenance ratios will be laid out in the future maintenance schedule in the report.	
10.2.	Do taxes paid apply as a credit to this work?	
10.2.1.	The Town indicated that this is separate from services paid for under general taxes.	
10.3.	Who completes the restoration and covers restoration costs?	
10.3.1.	The engineer indicated that this would be done as part of the pipe replacement. Owner and Town will take preconstruction photos.	
10.4.	Are landowners being treated differently here?	
10.4.1.	The Town indicated they are not and used the example that their water currently flows to the St. Louis Drain. If maintenance work were completed on the St. Louis Drain, the landowners would be assessed costs for that work.	
10.5.	Can their section of pipe be omitted from the work?	
10.5.1.	The engineer indicated that this issue would be required regardless of whether or not the S4 request was submitted because 1) the pipe is in poor condition and is in need of replacement, and 2) there is no agreement or mechanism currently in place to address any pipe repairs or maintenance.	
10.6.	Next Steps:	
10.6.1.	Survey	
10.6.2.	Report Preparation	
10.6.3.	Public Information Centre	
10.6.4.	Board Meetings	
10.6.5.	Meeting to Consider the technical aspects of the report	
10.6.6.	Court of Revision to discuss assessments	
10.6.7.	Landowners have right to appeal.	
10.6.8.	Landowners will receive notices and copy of the report in advance.	
10.6.9.	Timing?-report anticipated in the fall.	

Errors and/or Omissions

These minutes were prepared by Mark Hernandez, P.Eng., who should be notified of any errors and/or omissions.

MDH:jrb

"SCHEDULE C"
SCHEDULE OF ASSESSMENT
11TH CONCESSION DRAIN BRANCH
TOWN OF TECUMSEH

MUNICIPAL LANDS:

Description	Area Affected (Acres) (Ha.)		Owner	Special Benefit	Benefit	Outlet	Total Assessment
County Road No. 43 (11th Concession Road)	0.74	0.30	County of Essex	\$0.00	\$21,426.00	\$7,862.00	\$29,288.00
Total on Municipal Lands.....				\$0.00	\$21,426.00	\$7,862.00	\$29,288.00

PRIVATELY-OWNED - NON-AGRICULTURAL LANDS:

Roll No.	Con.	Description	Area Affected (Acres) (Ha.)		Owner	Special Benefit	Benefit	Outlet	Total Assessment
560-03506	10	Pt. Gore Lot 19 RP12R10865 Pt. Pts. 1&6	0.40	0.16	Christopher B. & Sherri-Lynn A. Roberts	\$0.00	\$4,156.00	\$2,517.00	\$6,673.00
560-03507	10	Pt. Gore Lot 19 RP12R10865 Pts. 2&7	0.23	0.09	Shelly Hodare	\$1,952.00	\$2,391.00	\$1,415.00	\$5,758.00
560-03508	10	Pt. Gore Lot 19 RP12R10865 Pts. 3&8	0.23	0.09	Catherine J. Urban	\$1,952.00	\$2,391.00	\$1,415.00	\$5,758.00
560-03509	10	Pt. Gore Lot 19 RP12R10865 Pts. 4&9	0.23	0.09	Bradley Kreitzer & Rene Lawrence	\$1,952.00	\$2,391.00	\$1,415.00	\$5,758.00
560-03510	10	Pt. Gore Lot 19 RP12R10865 Pts. 4&9	0.23	0.09	Luminita & Laurentiu Vasu	\$4,068.00	\$2,391.00	\$1,415.00	\$7,874.00
560-03511	10	Pt. Gore Lot 19 RP12R25489 Pt. 1	0.28	0.11	Dana Azar	\$0.00	\$0.00	\$1,730.00	\$1,730.00
560-03511	10	Pt. Gore Lot 19 RP12R25489 Pt. 2	0.26	0.11	Dana Azar	\$0.00	\$0.00	\$1,730.00	\$1,730.00
560-03511	10	Pt. Gore Lot 19 RP12R25489 Pt. 3	0.25	0.10	Dana Azar	\$0.00	\$0.00	\$1,572.00	\$1,572.00
560-03511	10	Pt. Gore Lot 19 RP12R25489 Pt. 4	0.38	0.15	Dana Azar	\$0.00	\$0.00	\$2,359.00	\$2,359.00
Total on Privately-Owned - Non-Agricultural Lands.....						\$9,924.00	\$13,720.00	\$15,568.00	\$39,212.00

TOTAL ASSESSMENT **\$9,924.00** **\$35,146.00** **\$23,430.00** **\$68,500.00**

	(Acres)	(Ha.)
Total Area:	3.23	1.29

"SCHEDULE D"
DETAILS OF SPECIAL BENEFIT
11TH CONCESSION DRAIN BRANCH
TOWN OF TECUMSEH

SPECIAL BENEFIT ASSESSMENT (NON PRORATABLE)
(NON-AGRICULTURAL LANDS)

Roll No.	Owner	Item Description	Estimated Cost	Cost of Report	Special Benefit
560-03507	Shelly Hodare	Driveway restoration with concrete surface at Station 0+015. Supply and placement of 150 mm thickness of 30 MPa concrete (approximately 1 m ³) match existing driveable top widths and existing surface elevations.	\$1,200.00	\$752.00	\$1,952.00
560-03508	Catherine J. Urban	Driveway restoration with concrete surface at Station 0+048. Supply and placement of 150 mm thickness of 30 MPa concrete (approximately 1 m ³) match existing driveable top widths and existing surface elevations.	\$1,200.00	\$752.00	\$1,952.00
560-03509	Bradley Kreitzer & Renee Lawrence	Driveway restoration with concrete surface at Station 0+057. Supply and placement of 150 mm thickness of 30 MPa concrete (approximately 1 m ³) match existing driveable top widths and existing surface elevations.	\$1,200.00	\$752.00	\$1,952.00
560-03510	Luminita & Laurentiu Vasu	Driveway restoration with interlocking brick surface at Station 0+078. Salvage and reinstallation of salvaged interlocking brick. Match existing driveable top widths and surface elevations. <i>Landowner may elect to perform this work.</i>	\$2,500.00	\$1,568.00	\$4,068.00
Total Special Benefit Assessment (Non-Agricultural Lands).....			\$6,100.00	\$3,824.00	\$9,924.00
OVERALL TOTAL SPECIAL BENEFIT ASSESSMENT					\$9,924.00

"SCHEDULE E"
SCHEDULE OF ASSESSMENT FOR FUTURE MAINTENANCE
11TH CONCESSION DRAIN BRANCH
TOWN OF TECUMSEH

MUNICIPAL LANDS:

Description	Area Affected		Owner	Special Benefit	Benefit	Outlet	Total Assessment
	(Acres)	(Ha.)					
County Road No. 43 (11th Concession Road)	0.74	0.30	County of Essex	\$0.00	\$2,131.00	\$1,506.00	\$3,637.00
Total on Municipal Lands.....				\$0.00	\$2,131.00	\$1,506.00	\$3,637.00

PRIVATELY-OWNED - NON-AGRICULTURAL LANDS:

Roll No.	Con.	Description	Area Affected		Owner	Special Benefit	Benefit	Outlet	Total Assessment
			(Acres)	(Ha.)					
560-03506	10	Pt. Gore Lot 19 RP12R10865 Pt. Pts. 1&6	0.40	0.16	Christopher B. & Sherri-Lynn A. Roberts	\$0.00	\$466.00	\$244.00	\$710.00
560-03507	10	Pt. Gore Lot 19 RP12R10865 Pts. 2&7	0.23	0.09	Shelly Hodare	\$0.00	\$373.00	\$171.00	\$544.00
560-03508	10	Pt. Gore Lot 19 RP12R10865 Pts. 3&8	0.23	0.09	Catherine J. Urban	\$0.00	\$373.00	\$195.00	\$568.00
560-03509	10	Pt. Gore Lot 19 RP12R10865 Pts. 4&9	0.23	0.09	Bradley Kreitzer & Rene Lawrence	\$0.00	\$373.00	\$220.00	\$593.00
560-03510	10	Pt. Gore Lot 19 RP12R10865 Pts. 4&9	0.23	0.09	Luminita & Laurentiu Vasu	\$0.00	\$373.00	\$246.00	\$619.00
560-03511	10	Pt. Gore Lot 19 RP12R25489 Pt. 1	0.28	0.11	Dana Azar	\$0.00	\$417.00	\$332.00	\$749.00
560-03511	10	Pt. Gore Lot 19 RP12R25489 Pt. 2	0.26	0.11	Dana Azar	\$0.00	\$417.00	\$332.00	\$749.00
560-03511	10	Pt. Gore Lot 19 RP12R25489 Pt. 3	0.25	0.10	Dana Azar	\$0.00	\$416.00	\$302.00	\$718.00
560-03511	10	Pt. Gore Lot 19 RP12R25489 Pt. 4	0.38	0.15	Dana Azar	\$0.00	\$661.00	\$452.00	\$1,113.00
Total on Privately-Owned - Non-Agricultural Lands.....				\$0.00	\$3,869.00	\$2,494.00	\$6,363.00		
TOTAL ASSESSMENT				\$0.00	\$6,000.00	\$4,000.00	\$10,000.00		

(Acres) (Ha.)
Total Area: 3.23 1.29

”SCHEDULE F”
DRAINAGE REPORT FOR THE
11TH CONCESSION DRAIN BRANCH
IN THE TOWN OF TECUMSEH

SPECIAL PROVISIONS - GENERAL

1.0 GENERAL SPECIFICATIONS

The General Specifications attached hereto is part of “Schedule F.” It also forms part of this specification and is to be read with it, but where there is a difference between the requirements of the General Specifications and those of the Special Provisions which follow, the Special Provisions will take precedence.

2.0 DESCRIPTION OF WORK

The work to be carried out under this Contract includes, but is not limited to, the supply of all **labour, equipment and materials** to complete the following items:

- Tile drain installation as follows:
 - Station 0+015 to Station 0+110 – Supply and install 95 metres of new 375 mm diameter solid (non-perforated) corrugated high density polyethylene (HDPE) smooth wall 320 kPa pipe (Boss 2000 or approved equal) with split coupler joints. Pipe installation is to include clearstone (minimum 150 mm thickness under pipe) bedding (approximately 35 tonnes), Granular ‘B’ up to pipe springline (approximately 40 tonnes) except under existing driveways where full Granular ‘B’ backfill (approximately 55 tonnes) is required with filter fabric wrapping (minimum 1 metre wide) over pipe joints, and native backfill beyond (approximately 50 m³). Work to include private drains to be connected. Removal and disposal of existing pipe and backfill materials off-site that is not suitable for native backfill. The work will include compaction of all backfill, placement of salvaged topsoil and regrading as specified. This work is to include the stripping of topsoil from the working corridor area prior to trench excavation, to be temporarily stockpiled and then restored following drain installation. Excavated topsoil and fill materials shall be stockpiled separately. Any existing tile and/or debris that may be unearthed throughout the trenching process and all excess materials to be disposed of, off-site.

Note: Existing backfill materials from the existing tile may be used where native backfill is specified provided no broken concrete, steel or other deleterious materials are used for this purpose. Where there is an insufficient amount of native fill materials for backfilling the culvert, the Contractor may elect to import additional fill materials or alternatively use Granular ‘B’ at his/her own expense. Any excess materials shall be disposed of off-site. Excess soils meet Table 1 ESQS with the exception of salt based parameters.

- Station 0+000B to Station 0+008B – Supply and install 8 metres of new 250 mm diameter PVC DR-35 pipe between existing CB1 and STMH42. Pipe installation is to include clearstone (minimum 150 mm thickness under pipe) bedding (approximately 5 tonnes), Granular ‘B’ up to pipe springline (approximately 2 tonnes) except under existing driveways where full Granular ‘B’ backfill (approximately 5 tonnes) is required with filter fabric wrapping (minimum 1 metre wide) over pipe joints, and native backfill beyond (approximately 5 m³). Removal and disposal of existing pipe and backfill materials off-site that is not suitable for native backfill. The work will include compaction of all backfill, placement of salvaged topsoil and regrading as specified. This work is to include the stripping of topsoil from the working corridor area prior to trench excavation, to be temporarily stockpiled and then restored following drain installation. Excavated topsoil and fill materials shall be stockpiled separately. Any existing tile and/or debris that may be unearthed throughout the trenching process and all excess materials to be disposed of, off-site.

Note: Existing backfill materials from the existing tile may be used where native backfill is specified provided no broken concrete, steel or other deleterious materials are used for this purpose. Where there is an insufficient amount of native fill materials for backfilling the culvert, the Contractor may elect to import additional fill materials or alternatively use Granular ‘B’ at his/her own expense. Any excess materials shall be disposed of off-site. Excess soils meet Table 1 ESQS with the exception of salt based parameters.

- Remove and dispose of existing four (4) catch basins.
- Supply and installation of four (4) new 750 mm diameter solid corrugated high density polyethylene (HDPE) smooth wall (Boss 2000 or approved equal) catch basins (denoted as CB on drawings) complete with cast iron grate and a minimum 300 mm deep sump. Work is to include connection of all new drain pipes and grouting all voids around pipes with non-shrink concrete grout and fine grading and seeding in disturbed areas.
- Driveway restoration as follows:
 - Driveway restoration with gravel surface at Station 0+004B. Supply, placement and compact Granular ‘A’ (crushed limestone) driveway surface, minimum 200 mm thickness (approximately 5 tonnes) matching existing driveable top widths and surface elevations.
 - Driveway restoration with concrete surface at Station 0+015. Supply and placement of 150 mm thickness of 30 MPa concrete (approximately 1 m³) match existing driveable top widths and existing surface elevations.
 - Driveway restoration with concrete surface at Station 0+048. Supply and placement of 150 mm thickness of 30 MPa concrete (approximately 1 m³) match existing driveable top widths and existing surface elevations.

- Driveway restoration with concrete surface at Station 0+057. Supply and placement of 150 mm thickness of 30 MPa concrete (approximately 1 m³) match existing driveable top widths and existing surface elevations.
- Driveway restoration with interlocking brick surface at Station 0+078. Salvage and reinstallation of salvaged interlocking brick. Match existing driveable top widths and surface elevations. Landowner may elect to perform this work.
- Station 0+015 to Station 0+132 – Regrading and seeding of disturbed grassed areas including placement of topsoil (minimum 100 mm layer) on west side of County Road No. 43 (11th Concession Road)(approximately 120 m²)
- Temporary silt control measures during construction

3.0 ACCESS TO THE WORK

Access to the drain shall be from the 11th Concession Road (County Road No. 43). The Contractor shall make his/her own arrangements for any additional access for his/her convenience. All road areas and grass lawn areas disturbed shall be restored to original conditions at the Contractor's expense.

4.0 WORKING AREA

The working area shall be within the 11th Concession Road (County Road No. 43) right-of-way. One lane shall remain open during the construction period and traffic control (found in General Specifications) maintained at all times.

The Contractor shall restrict his equipment to the working corridor as specified in this Section. Any damage resulting from non-compliance with this Section shall be borne by the Contractor.

Should the contractor elect to make use of any private lands outside the designated area, he will be responsible to negotiate any terms for use of these lands with the property owner, and be responsible for any damages that occur.

SPECIAL PROVISIONS – TILE DRAIN

5.0 DRAINAGE PIPE CONSTRUCTION

5.1 Setting Out

The Engineer shall provide the Contractor in writing with benchmarks and points of reference. From these benchmarks and points of reference, the contractor will do his own setting out. The setting out by the Contractor shall include but shall not be limited to the preparation of grade sheets, the installation of centerline stakes, grade stakes, offsets, and sight rails.

If, during the setting out, the contractor finds an error in the benchmarks or points of reference provided by the Engineer or is uncertain as to the interpretation of the information provided or the work intended, he shall notify the Engineer immediately for additional verification or clarification before proceeding with construction.

The Contractor shall be responsible for the true and proper setting out of the works and for the correctness of the position, levels, dimensions and alignment of all parts of the work.

The Contractor shall be responsible to ensure that the alignment selected results in a minimum depth of cover of 600 mm over the top of the drainage pipe to be installed.

If, at any time during the progress of the works, an error shall appear or arise in the position, levels, dimensions or alignment of any part of the works, the Contractor shall, at his own expense, rectify such error to the satisfaction of the Engineer, unless such error is based on incorrect data supplied in writing by the Engineer.

5.2 Alignment and Removal of Existing Tile Drain and Catch Basins

Prior to commencing the work, the Contractor is to locate the course of the 11th Concession Drain Branch corrugated steel pipe and mark it in the field at 30 m intervals before establishing the alignment for the proposed work.

The drainage pipe shall be laid on the same alignment as the existing tile drain that is to be removed. The Contractor shall remove the existing corrugated steel pipe entirely as the work progresses upstream. After the existing tile drain has been removed it shall be disposed of off-site at an approved disposal location. Excavations shall be backfilled and compacted in maximum 150 mm lifts to 100 percent Standard Proctor Density.

The Contractor shall maintain all drainage prior to removing the existing corrugated steel pipe and catch basins.

5.3 Profile

The drainage pipe shall be laid so that its invert shall be at the gradeline shown on the profile, which gradeline is governed by the benchmarks. The profile shows, for the convenience of the Contractors and others, the approximate depth of cut from the surface of the ground at 50 metre intervals, to the final invert of the drainage pipe in metres and decimals of a metre. Benchmarks, which have been established along the course of the drain, shall govern the final elevation of the drain. The locations and elevations of the benchmarks are shown on the General Details.

Maximum acceptable deviations in the sewer grade shall be +/- 0.02% which is equivalent to 20 mm in 100 m of installation.

5.4 Obstructions

All brush, timber, logs, stumps, stones or other obstructions that interfere with the construction of the drain, encountered along the course of the drain are to be removed by the Contractor. Timber, logs and stumps are to be dealt with in the same manner as specified for brush and trees. Large stones and other similar material are to be piled near the limit of the working corridor and the disposal of this material will be the responsibility of the Owner.

5.5 Location of New Tile Drain

The new tile drain shall be installed as shown on the Drawings attached hereto.

5.6 Drainage Pipe Materials

5.6.1 H.D.P.E. Pipe

Tile Drain (Sta. 0+015 to Sta. 0+110) New 375 mm (15") diameter corrugated High Density Polyethylene (H.D.P.E.) smooth wall interior (Armtex Boss 2000 or approved equivalent) unless otherwise specified conforming to the following specifications: ASTM @3350, CSA B182.8-02 and OPSS 1840. The pipe is to provide a minimum pipe stiffness of 320 kPa.

Joined using (soil tight) "split" coupler joining system (Split couplers manufactured by Armtex Limited or approved equal), supplied by the pipe manufacturer and conforming to ASTM D3350, CSA 182.8-02 and OPSS 1840. Joints wrapped in "Non-Woven" geotextile filter fabric with a minimum strength equal to or greater than Terrafix 270R, Amoco 446, Mirafi 140NC or approved equivalent.

Tile Drain (Sta. 0+000B to Sta. 0+008B) New 250 mm (10") diameter PVC DR-35 gasketed pipe conforming to CSA B182.2 and ASTM D3034.

<i>Pipe Bedding</i>	<i>Granular 'A' conforming to OPSS Division 10 or 20-25 mm clearstone conforming to OPSS Division 10.</i>
<i>Pipe Backfill to Pipe Springline</i>	<i>Granular 'B' conforming to OPSS Division 10.</i>
<i>Native Backfill Above</i>	<i>Dry native material free of topsoil, organic matter, broken concrete, steel, wood and deleterious substances.</i>
<i>Pipe Backfill under Driveways</i>	<i>Granular 'A' conforming to OPSS Division 10.</i>
<i>Gravel Driveway Restoration</i>	<i>Granular 'A' conforming to OPSS Division 10.</i>
<i>Filter Fabric</i>	<i>"Non-Woven" geotextile filter fabric with a minimum strength equal to or greater than Terrafix 270R, Amoco 4546, Mirafi 140NC or approved equivalent.</i>
<i>Erosion Stone</i>	<i>All stone to be used for erosion protection shall be 125 – 250 mm clear quarried rock or OPSS 1001, minimum 300 mm thickness.</i>

5.7 Maintenance of Flow in Sewers

The Contractor shall at his own cost and expense, permanently provide for and maintain the flow in all sewers or ditches which may be encountered during the progress of the work. This work shall include measures by the contractor to facilitate methods of construction and staging of the works, while maintaining flows.

5.8 Excavating the Trench

Construction of the trench shall normally start at the outlet and proceed upstream and be by excavator. The trench walls may be cut vertically to a height of 1 metre from the trench bottom. Beyond 1 metre of the trench bottom the walls are to be cut to 1:1 side slopes.

Minimum width of trench, measured at the top of the drainage pipe, shall be equal to the outside diameter of the drainage pipe plus approximately half of the outside pipe diameter on both sides of the pipe, to permit proper granular material bedding placement around the drainage pipe.

The bottom of the trench shall be cut to a minimum of 150 mm below the gradeline to allow for the Granular 'A' or clearstone bedding materials.

Any additional excavated material not required for backfilling purposes shall be disposed of off-site.

The topsoil is to be separated from the subsoil and during the backfilling operation it shall be replaced as the top layer.

5.9 Laying Drainage Pipe

The Contractor shall supply and install Granular A' or clearstone material for bedding, placed to a depth of 150 mm below the design invert of the pipe and shaped to receive the pipe. After pipe placement, Granular 'B' backfill shall be placed and compacted to the springline of the pipe throughout its entire length and then to the top of the trench.

Laying of the drainage pipe shall normally begin at the lower end of the drain and progress upstream.

All soil or debris in the drainage pipe shall be removed before installation.

All drainage pipes shall be free from clinging wet or frozen material that would hinder the laying of the drainage pipe on grade.

Before work is suspended for the day, all drainage pipe laid in trenches shall be blinded and any open ends closed.

5.10 Utility Supports

The contractor shall construct permanent reinforced concrete utility supports as required by the respective Utility Companies. Permanent utility supports, constructed in accordance with the Contract Drawings shall be considered incidental to this item. No payment shall be made for supports either temporary or permanent.

5.11 Blinding

As the laying of drainage pipe progresses, the drainage pipe shall be blinded by placing crumbly sub-soils from the springline of the pipe to a minimum depth of 150 mm above the top of pipe.

Drainage pipe laid in open trenches shall be blinded by the end of each day.

Large stones and frozen lumps of soil shall not be permitted in the blinding material.

On steep grades, or where the topsoil contains fine sand, loam or clay soil (if available from the sides of the trench) shall be used as blinding material.

5.12 Backfilling

Large stones, roots, broken pipe and other material likely to impede or damage field equipment shall be removed from the backfill and placed in a suitable disposal area by the Contractor.

To avoid the danger of damaging the drainage pipe, large stones and lumps of frozen earth may not be placed in the trench during the backfill operation.

Where plastic tubing is not blinded in a separate operation, a backfilling method shall be used that permits backfill material to roll into the trench and provide uniform soil placement around tubing, immediately after installation.

Except at laneways and road crossings, backfill material shall not be compacted; compaction shall be allowed to occur naturally.

5.13 New Drain Connections

New drain connections shall be connected to the new drainage pipe with prefabricated HDPE tees. Existing drains shall be inspected by the Drainage Superintendent and if found to be in working order, they shall be connected to the new system. Drains containing very little sediment shall be directly connected and drains containing substantial quantities of sediment shall be directly connected through filter material.

Drains carrying sewage or farmstead wastes shall not be connected to the drainage system.

Plastic tubing connections to rigid drainage pipe shall be made with manufactured plastic adapters.

Directional changes in plastic tubing may be made without the use of fittings provided that the centre line radius of the bend is not less than five times the tubing diameter.

Manufactured “T”, “Y” or elbow fittings shall be used for connections at the junction of two drains.

All connections shall be carried out by the Contractor as part of his work. The cost of connections shall be at the expense of the drain.

5.14 New Yard Catch Basins (CB)

The Contractor shall arrange for the supply and installation of concrete catch basins at the locations and elevations as shown on the drawings.

The Contractor shall arrange for the supply and installation of four (4) 750 mm diameter solid corrugated high density polyethylene (HDPE) smooth wall 320 kPa pipe (Boss 2000 or approved equal) catch basins with a 750 mm diameter cast iron grate.

The base of the catch basin shall consist of a minimum layer of 300 mm of 20-25 mm clearstone. The base elevation shall be at least 300 mm below the invert of the outlet pipe in the wall of the catch basin.

Catch basins shall be backfilled with clean native materials in maximum lifts of 300 mm lifts and compacted to 98% of the maximum standard proctor density. Locations to be field fit based on site specific grading and in consultation with the homeowner.

6.0 SEEDING

All existing grassed areas disturbed by construction or as identified as new or existing grass buffers shall be seeded as specified herein. The existing ground surface to be seeded shall be loosened to a depth of 25 mm and shall be rendered uniformly loose for that 25 mm depth. The surface shall be predominantly fine and free from weeds and other unwanted vegetation. All other loose surface litter shall be removed and disposed of. If mulching is required, it shall be carried out by the contractor as part of the item's tendered price.

Grass seed shall be Canada No. 1 grass seed mixture meeting the requirements of a Waterway Slough Mixture as supplied by Growmark or approved equal, as follows:

<i>Creeping Red Fescue</i>	20%
<i>Meadow Fescue</i>	30%
<i>Tall Fescue</i>	30%
<i>Timothy</i>	10%
<i>White Clover</i>	10%

Bags shall bear the label of the supplier indicating the content by species, grade and mass. Seed shall be applied at a rate of 200 kg per 10,000 m².

Fertilizer shall be 8-32-16 applied at 350 kg per 10,000 m². It shall be in granular form, dry, free from lumps and in bags bearing the label of the manufacturer, indicating mass and analysis.

The seeding shall be deemed "Completed by the Contractor" when the seed has established in all areas to the satisfaction of the Engineer. Re-seeding and/or other methods required to establish the grass will be given consideration to achieve the end result and the costs shall be incidental to the works.

7.0 GRANULAR 'A' DRIVEWAY RESTORATION

The Contractor shall construct the driveway with a maximum 3% longitudinal grade approach over the new culvert providing a minimum 300 mm cover. This work includes the installation of a minimum 200 mm thickness of compacted Granular 'A' (crushed limestone) surface. The minimum top width of the driveway shall be as shown on the drawings.

8.0 INTERLOCKING DRIVEWAY RESTORATION

Interlocking brick driveways shall be constructed as follows:

- Salvaged interlocking brick
- Minimum 200 mm Granular 'A'

9.0 CONCRETE DRIVEWAY RESTORATION

Concrete driveways shall be constructed as follows:

- 150 mm thick 30MPa concrete
- Minimum 200 mm Granular 'A'

10.0 SITE CLEANUP AND RESTORATION

As part of the work and upon completion, the Contractor shall remove and dispose of, off-site any loose timber, logs, stumps, large stones, rubber tires, cinder blocks or other debris from the drain bottom and from the side slopes. Where the construction works cross a lawn, the Contractor shall take extreme care to avoid damaging the lawn, shrubs and trees encountered. Upon completion of the work, the Contractor shall completely restore the area by the placement and fine grading of topsoil and seeding or sodding the area as specified by the Engineer or Drainage Superintendent.

GENERAL SPECIFICATIONS

1.0 AGREEMENT AND GENERAL CONDITIONS

The part of the Specifications headed "Special Provisions" which is attached hereto forms part of this Specification and is to be read with it. Where there is any difference between the requirements of this General Specification and those of the Special Provisions, the Special Provisions shall govern.

Where the word "Drainage Superintendent" is used in this specification, it shall mean the person or persons appointed by the Council of the Municipality having jurisdiction to superintend the work.

Tenders will be received and contracts awarded only in the form of a lump sum contract for the completion of the whole work or of specified sections thereof. The Tenderer agrees to enter into a formal contract with the Municipality upon acceptance of the tender. The General Conditions of the contract and Form of Agreement shall be those of the Stipulated Price Contract CCDC2-Engineers, 1994 or the most recent revision of this document.

2.0 EXAMINATION OF SITE, PLANS AND SPECIFICATIONS

Each tenderer must visit the site and review the plans and specifications before submitting his/her tender and must satisfy himself/herself as to the extent of the work and local conditions to be met during the construction. Claims made at any time after submission of his/her tender that there was any misunderstanding of the terms and conditions of the contract relating to site conditions, will not be allowed. The Contractor will be at liberty, before bidding to examine any data in the possession of the Municipality or of the Engineer.

The quantities shown or indicated on the drawings or in the report are estimates only and are for the sole purpose of indicating to the tenderers the general magnitude of the work. The tenderer is responsible for checking the quantities for accuracy prior to submitting his/her tender.

3.0 MAINTENANCE PERIOD

The successful Tenderer shall guarantee the work for a period of one (1) year from the date of acceptance thereof from deficiencies that, in the opinion of the Engineer, were caused by faulty workmanship or materials. The successful Tenderer shall, at his/her own expense, make good and repair deficiencies and every part thereof, all to the satisfaction of the Engineer. Should the successful Tenderer for any cause, fail to do so, then the Municipality may do so and employ such other person or persons as the Engineer may deem proper to make such repairs or do such work, and the whole costs, charges and expense so incurred may be deducted from any amount due to the Tenderer or may be collected otherwise by the Municipality from the Tenderer.

4.0 GENERAL CO-ORDINATION

The Contractor shall be responsible for the coordination between the working forces of other organizations and utility companies in connection with this work. The Contractor shall have no cause of action against the Municipality or the Engineer for delays based on the allegation that the site of the work was not made available to him by the Municipality or the Engineer by reason of the acts, omissions, misfeasance or non-feasance of other organizations or utility companies engaged in other work.

5.0 RESPONSIBILITY FOR DAMAGES TO UTILITIES

The Contractor shall note that overhead and underground utilities such as hydro, gas, telephone and water are not necessarily shown on the drawings. It is the Contractor's responsibility to contact utility companies for information regarding utilities, to exercise the necessary care in construction operations and to take other precautions to safeguard the utilities from damage. All work on or adjacent to any utility, pipeline, railway, etc., is to be carried out in accordance with the requirements of the utility, pipeline, railway, or other, as the case may be, and its specifications for such work are to be followed as if they were part of this specification. The Contractor will be liable for any damage to utilities.

6.0 CONTRACTOR'S LIABILITY

The Contractor, his/her agents and all workmen or persons under his/her control including sub-contractors, shall use due care that no person or property is injured and that no rights are infringed in the prosecution of the work. The Contractor shall be solely responsible for all damages, by whomsoever claimable, in respect to any injury to persons or property of whatever description and in respect of any infringement of any right, privilege or easement whatever, occasioned in the carrying on of the work, or by any neglect on the Contractor's part.

The Contractor, shall indemnify and hold harmless the Municipality and the Engineer, their agents and employees from and against claims, demands, losses, costs, damages, actions, suits, or proceedings arising out of or attributable to the Contractor's performance of the contract.

7.0 PROPERTY BARS AND SURVEY MONUMENTS

The Contractor shall be responsible for marking and protecting all property bars and survey monuments during construction. All missing, disturbed or damaged property bars and survey monuments shall be replaced at the Contractor's expense, by an Ontario Land Surveyor.

8.0 MAINTENANCE OF FLOW

The Contractor shall, at his/her own cost and expense, permanently provide for and maintain the flow of all drains, ditches and water courses that may be encountered during the progress of the work.

9.0 ONTARIO PROVINCIAL STANDARDS

Ontario Provincial Standard Specifications (OPSS) and Ontario Provincial Standard Drawings (OPSD) shall apply and govern at all times unless otherwise amended or extended in these Specifications or on the Drawing. Access to the electronic version of the Ontario Provincial Standards is available online through the MTO website, free of charge to all users. To access the electronic standards on the Web go to <http://www.mto.gov.on.ca/english/transrd/>. Under the title Technical Manuals is a link to the Ontario Provincial Standards. Users require Adobe Acrobat to view all pdf files.

10.0 APPROVALS, PERMITS AND NOTICES

The construction of the works and all operations connected therewith are subject to the approval, inspection, by-laws and regulations of all Municipal, Provincial, Federal and other authorities having jurisdiction in respect to any matters embraced in this Contract. The Contractor shall obtain all approvals and permits and notify the affected authorities when carrying out work in the vicinity of any public utility, power, underground cables, railways, etc.

11.0 SUBLETTING

The Contractor shall keep the work under his/her personal control, and shall not assign, transfer, or sublet any portion without first obtaining the written consent of the Municipality.

12.0 TIME OF COMPLETION

The Contractor shall complete all work on or before the date fixed at the time of tendering. The Contractor will be held liable for any damages or expenses occasioned by his/her failure to complete the work on time and for any expenses of inspection, superintending, re-tendering or re-surveying, due to their neglect or failure to carry out the work in a timely manner.

13.0 TRAFFIC CONTROL

The Contractor will be required to control vehicular and pedestrian traffic along roads at all times and shall, at his/her own expense, provide for placing and maintaining such barricades, signs, flags, lights and flag persons as may be required to ensure public safety. The Contractor will be solely responsible for controlling traffic and shall appoint a representative to maintain the signs and warning lights at night, on weekends and holidays and at all other times that work is not in progress. All traffic control during construction shall be strictly in accordance with the **Occupational Health and Safety Act** and

the current version of the **Ontario Traffic Manuals**. Access to the electronic version of the **Ontario Traffic Manual** is available online through the MTO website, free of charge to all users. To access the electronic standards on the Web go to <http://www.mto.gov.on.ca/english/transrd/>, click on "Library Catalogue," under the "Title," enter "Ontario Traffic Manual" as the search. Open the applicable "Manual(s)" by choosing the "Access Key," once open look for the "Attachment," click the pdf file. Users require Adobe Acrobat to view all pdf files.

Contractors are reminded of the requirements of the Occupational Health and Safety Act pertaining to Traffic Protection Plans for workers and Traffic Control Plan for Public Safety.

14.0 SITE CLEANUP AND RESTORATION

As part of the work and upon completion, the Contractor shall remove and dispose of, off-site any loose timber, logs, stumps, large stones, rubber tires, cinder blocks or other debris from the drain bottom and from the side slopes. Where the construction works cross a lawn, the Contractor shall take extreme care to avoid damaging the lawn, shrubs and trees encountered. Upon completion of the work, the Contractor shall completely restore the area by the placement and fine grading of topsoil and seeding or sodding the area as specified by the Engineer or Drainage Superintendent.

15.0 UTILITY RELOCATION WORKS

In accordance with Section 26 of the Drainage Act, if utilities are encountered during the installation of the drainage works that conflict with the placement of the new culvert, the operating utility company shall relocate the utility at their own costs. The Contractor however will be responsible to co-ordinate these required relocations (if any) and their co-ordination work shall be considered incidental to the drainage works.

16.0 FINAL INSPECTION

All work shall be carried out to the satisfaction of the Drainage Superintendent for the Municipality, in compliance with the specifications, drawings and the Drainage Act. Upon completion of the project, the work will be inspected by the Engineer and the Drainage Superintendent. Any deficiencies noted during the final inspection shall be immediately rectified by the Contractor.

Final inspection will be made by the Engineer within 20 days after the Drainage Superintendent has received notice in writing from the Contractor that the work is completed, or as soon thereafter as weather conditions permit.

17.0 FISHERIES CONCERNS

Standard practices to be followed to minimize disruption to fish habitat include embedment of the culvert a minimum 10% below grade, constructing the work 'in the dry' and cutting only trees necessary to do the work (no clear-cutting). No in-water work is to occur during the timing window unless otherwise approved by the appropriate authorities.

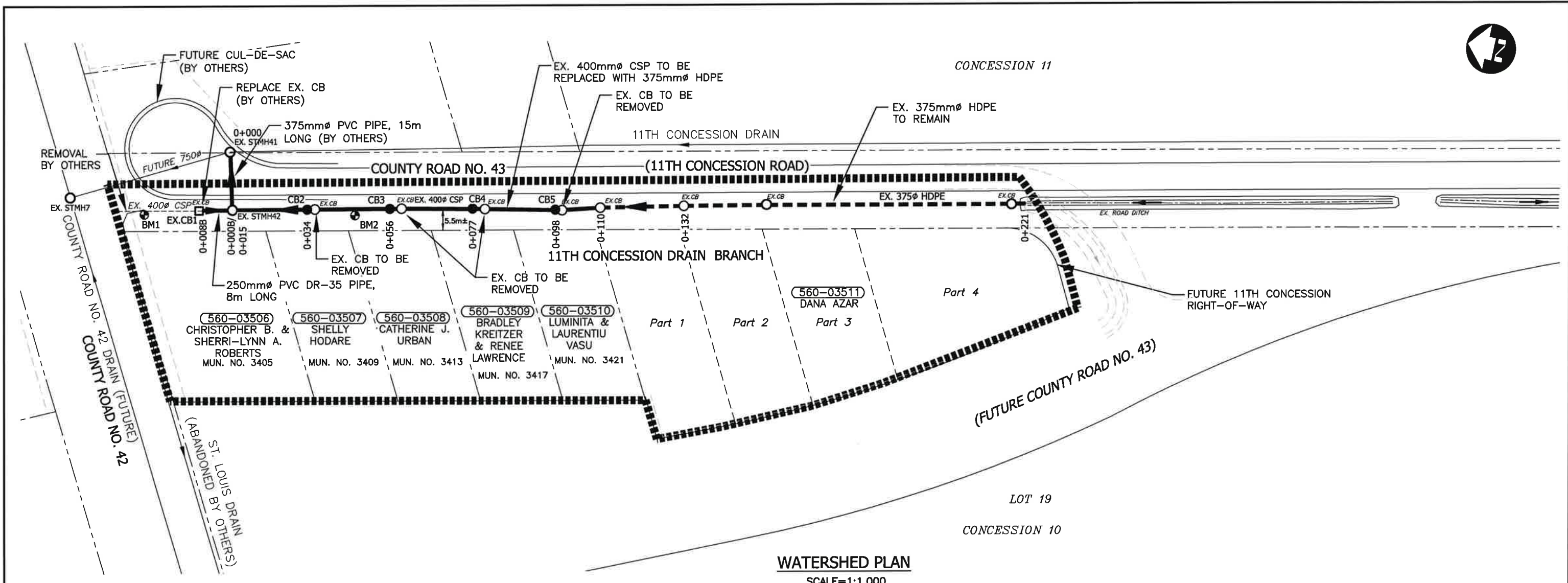

WATERSHED PLAN
SCALE=1:1,000

LEGEND	
	11TH CONCESSION DRAIN BRANCH DRAINAGE AREA
	11TH CONCESSION DRAIN BRANCH (EX. CSP) TO BE REPLACED W/ HDPE
	11TH CONCESSION DRAIN BRANCH (EX. HDPE)
	OTHER DRAINS
	EXISTING CATCHBASIN
	NEW CATCHBASIN
	SITE BENCHMARK

SITE BENCHMARKS	
BM1-	TOP OF CONCRETE HEADWALL AT SOUTHWEST CORNER OF INTERSECTION OF COUNTY ROAD NO. 42 & COUNTY ROAD NO. 43 (11TH CONCESSION ROAD). ELEVATION=183.54m
BM2-	TOP OF FIRE HYDRANT AT THE LINE BETWEEN MUN. NO. 3409 & 3413 AT APPROX. STATION 0+045. ELEVATION=184.45m

NOTE: CONTRACTOR TO VERIFY BENCHMARKS PRIOR TO CONSTRUCTION. IF A BENCHMARK HAS BEEN DESTROYED, MISSING OR A DISCREPANCY FOUND CONTACT THE ENGINEER AS SOON AS POSSIBLE.

11TH CONCESSION BRANCH DRAIN CATCH BASIN DETAILS				
CB No.	SIZE(mm)	TOP ELEV. (m)	INV. ELEV. (m)	
EX. 1	600x600	183.45	182.56(S)	
2	750	183.50	182.55(S)	182.55(N)
3	750	183.70	182.56(S)	182.56(N)
4	750	183.77	182.57(S)	182.57(N)
5	750	183.76	182.58(S)	182.58(N)



Conditions of Use
Verify elevations and/or dimensions on drawing prior to use. Report any discrepancies to Dillon Consulting Limited.
Do not scale dimensions from drawing.
Do not modify drawing, re-use it, or use it for purposes other than those intended at the time of its preparation without prior written permission from Dillon Consulting Limited.

No.	ISSUED FOR	DATE	BY
4	FINAL REPORT SUBMISSION	FEB. 7/23	MDH
3	PUBLIC INFORMATION CENTRE REVIEW	DEC. 6/22	MDH
2	ERCA REVIEW	NOV. 9/22	MDH
1	CLIENT REVIEW	SEPT. 23/22	MDH

DESIGN	MDH	REVIEWED BY	CDP
DRAWN	WLB	CHECKED BY	TRO
DATE	February 7, 2023		
SCALE	AS SHOWN		

DILLON CONSULTING
PROJECT NO. 22-3557
DRAWING SCALES BASED ON A 11" X 17" SHEET

'SCHEDULE G'
Drainage Report for the
11TH CONCESSION DRAIN BRANCH
Town of Tecumseh
SHEET TITLE **WATERSHED PLAN**
PAGE NO. 1 of 3

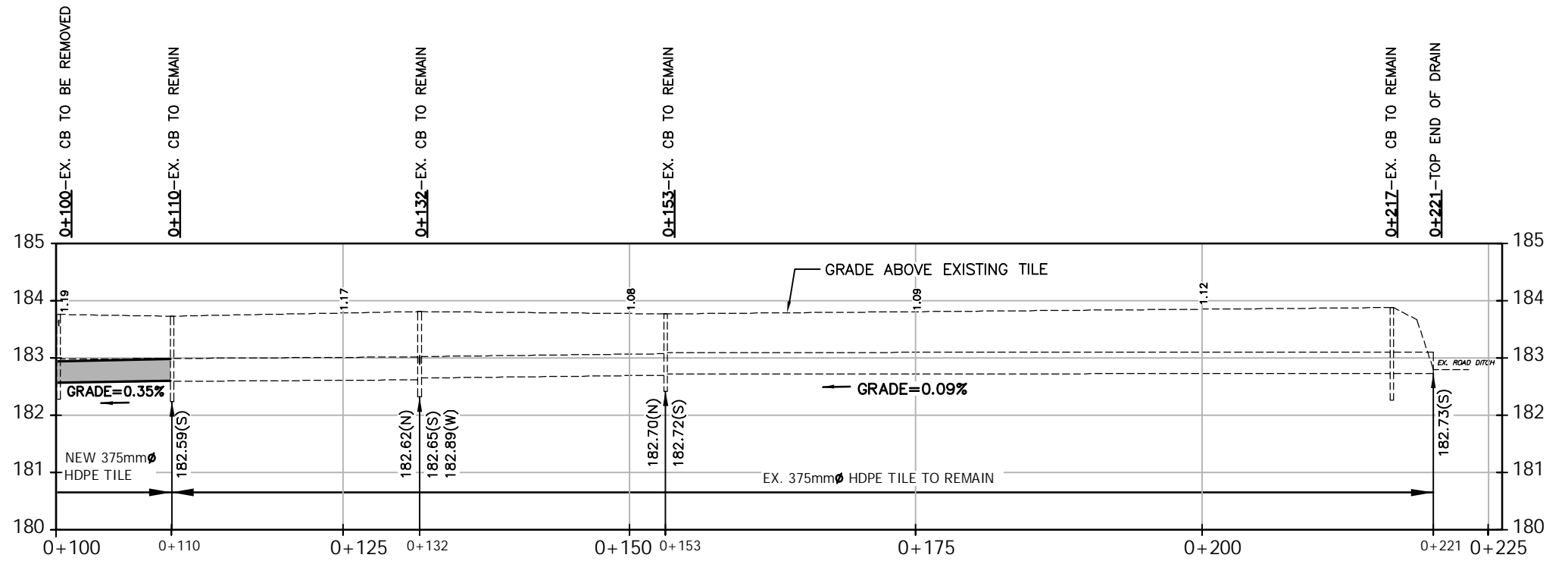
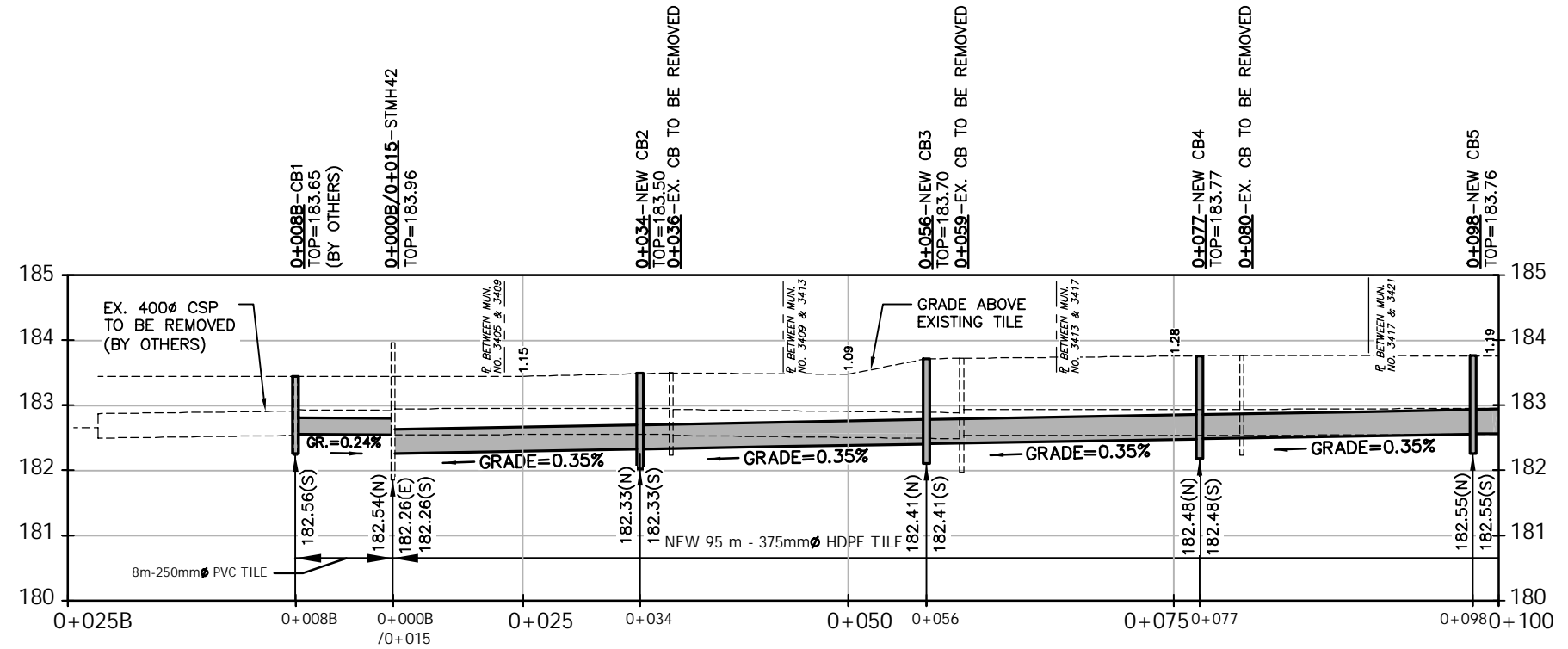
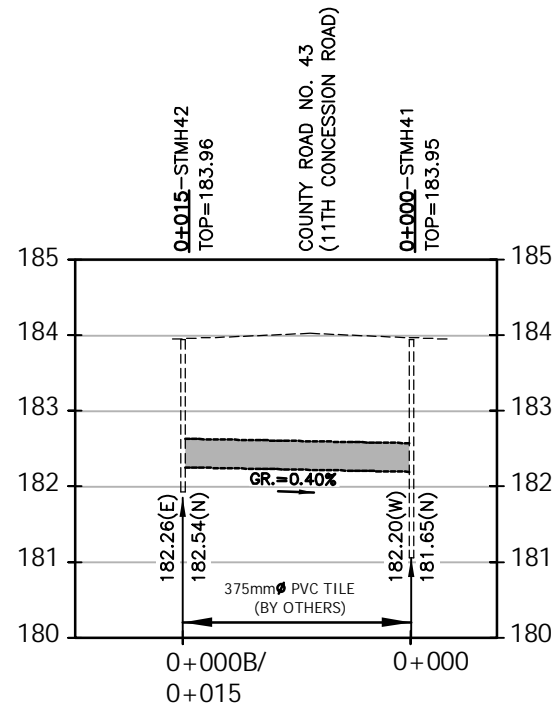

PROFILE
SCALE=HORIZ.=1:500
VERT.=1:100



Conditions of Use

Verify elevations and/or dimensions on drawing prior to use. Report any discrepancies to Dillon Consulting Limited.
Do not scale dimensions from drawing.
Do not modify drawing, re-use it, or use it for purposes other than those intended at the time of its preparation without prior written permission from Dillon Consulting Limited.

No.	ISSUED FOR	DATE	BY
4	FINAL REPORT SUBMISSION	FEB. 7/23	MDH
3	PUBLIC INFORMATION CENTRE REVIEW	DEC. 6/22	MDH
2	ERCA REVIEW	NOV. 9/22	MDH
1	CLIENT REVIEW	SEPT. 23/22	MDH

DESIGN	REVIEWED BY
MDH	CDP
DRAWN	CHECKED BY
WLB	TRO
DATE	February 7, 2023
SCALE	AS SHOWN

	PROJECT NO.	22-3557
	DRAWING SCALES BASED ON A 11" X 17" SHEET	

'SCHEDULE G'	
Drainage Report for the 11TH CONCESSION DRAIN BRANCH Town of Tecumseh	
SHEET TITLE	PROFILE
PAGE NO.	2 of 3

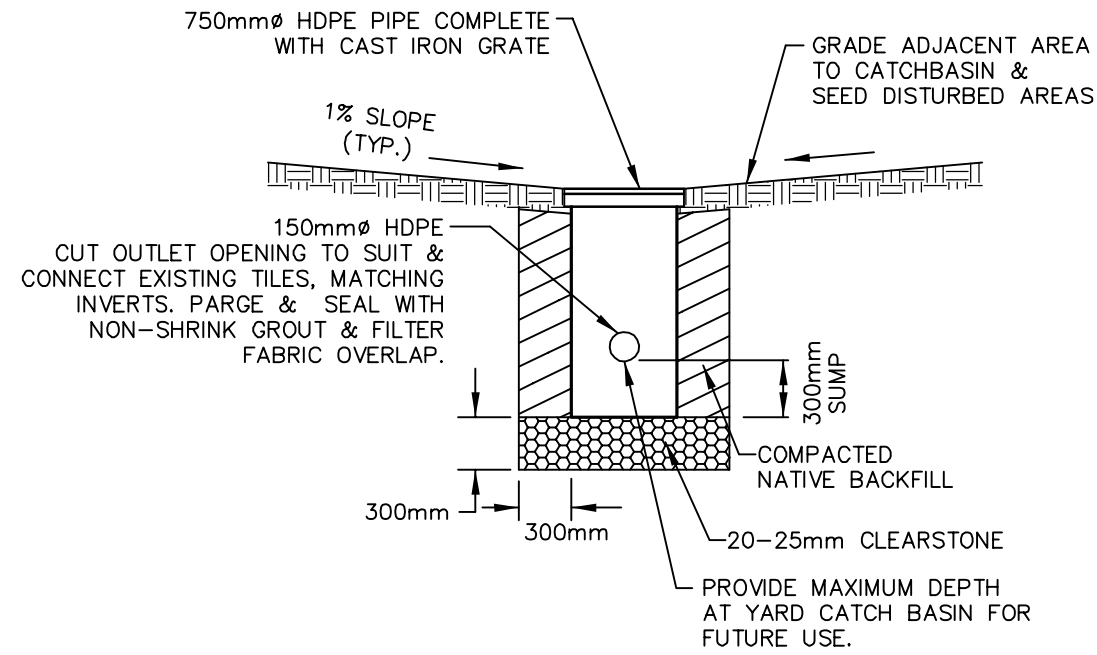

YARD CATCH BASIN DETAIL
(750mmØ HDPE)
N.T.S.

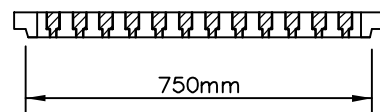
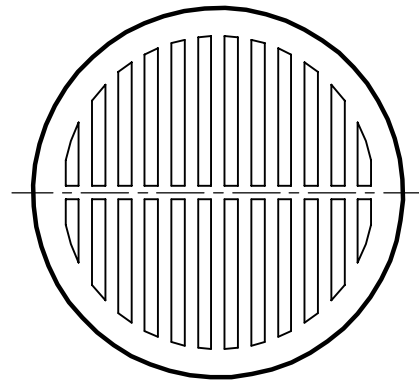

STANDARD CAST IRON GRATE FOR
750mmØ HDPE CATCH BASIN
N.T.S.

NOMINAL PIPE INSIDE DIAMETER D (mm)	MINIMUM TRENCH WIDTH W (mm)	MINIMUM BEDDING BELOW d (mm) (SEE NOTE 2)
FLEXIBLE PIPE		
under 1200	O.D. + 600	150

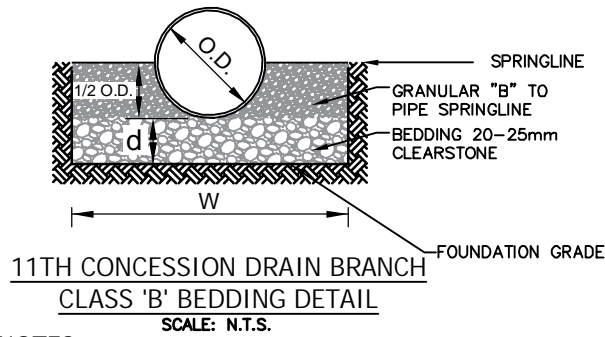

BEDDING NOTES

- O.D. = OUTSIDE DIAMETER OF PIPE.
- IN ROCK TRENCHES, BEDDING DEPTH (d) BELOW PIPES SHALL BE INCREASED TO 300mm.
- HAUNCHING AND COVER MATERIAL TO BE NATIVE BACKFILL.
- GRANULAR "A" BEDDING SHALL NOT CONTAIN RECYCLED ASPHALT.
- ALL BEDDING MATERIAL MUST BE COMPACTED TO 98% STANDARD PROCTOR DENSITY.
- IF SOFT TRENCH BOTTOM ENCOUNTERED, BEDDING DEPTH TO BE INCREASED TO 300mm & CONSIST OF GRANULAR 'A' OR CLEARSTONE W/FILTER FABRIC UNDERLAY.



Conditions of Use

Verify elevations and/or dimensions on drawing prior to use. Report any discrepancies to Dillon Consulting Limited.
Do not scale dimensions from drawing.
Do not modify drawing, re-use it, or use it for purposes other than those intended at the time of its preparation without prior written permission from Dillon Consulting Limited.

No.	ISSUED FOR	DATE	BY
4	FINAL REPORT SUBMISSION	FEB. 7/23	MDH
3	PUBLIC INFORMATION CENTRE REVIEW	DEC. 6/22	MDH
2	ERCA REVIEW	NOV. 9/22	MDH
1	CLIENT REVIEW	SEPT. 23/22	MDH

DESIGN	MDH	REVIEWED BY	CDP
DRAWN	WLB	CHECKED BY	TRO
DATE	February 7, 2023		
SCALE	AS SHOWN		

PROJECT NO. 22-3557
DRAWING SCALES BASED ON A 11" X 17" SHEET

'SCHEDULE G'
Drainage Report for the
11TH CONCESSION DRAIN BRANCH
Town of Tecumseh

SHEET TITLE: **DETAILS**
PAGE NO.: 3 of 3