

SHUTTLEWORTH DRAIN

E09SH(88)

(Repair and Improvement)

RECONSIDERED REPORT

Geographic Township of Sandwich South

TOWN OF TECUMSEH



Town of Tecumseh
917 Lesperance Road
Tecumseh, Ontario N8N 1W9
519-735-2184

Rood Engineering Inc.

Consulting Engineers

9 Nelson Street

Leamington, Ontario N8H 1G6

519-322-1621

REI Project 2017D020

August 21st, 2023

August 21st, 2023

Mayor and Municipal Council
Corporation of the Town of Tecumseh
917 Lesperance Road
Tecumseh, Ontario
N8N 1W9

Mayor McNamara and Members of Council:

**SHUTTLEWORTH DRAIN – RECONSIDERED REPORT
E09SH(88) - Geographic Twp. of Sandwich South
Project REI2017D020
Town of Tecumseh, County of Essex**

I. INTRODUCTION

Council instructions to reconsider the drainage report at their May 9th, 2023 meeting was confirmed by letter dated May 12th, 2023 from your Director Legislative Services & Clerk Robert Auger. Our original report was prepared in accordance with the instructions provided at your June 13th, 2017 meeting and received from the Town by letter dated June 25th, 2017, from Laura Moy your former Director Corporate Services & Clerk, and we had prepared the previous report that provided for new replacement bridges, enclosures, and repair and improvement to the open drain and ancillary work. In consultation with the Town Drainage Department Staff, we have communicated with owners that have desired their enclosures to be eliminated and to only provide them with a standard access bridge. Detailed investigations by Town Staff and our office have confirmed the very poor condition of the Bridge 7 enclosure and its need to be replaced to avoid problems and complications from arising. Discussions with the owners confirmed that the full enclosure was desired when replacement was required rather than just a standard access bridge. The Shuttleworth Drain comprises of an open drain with an enclosure at the east end generally located along the north side of North Talbot Road extending from its outlet in the Washbrook Drain, proceeding easterly to the 9th Concession Drain located along the west side of the 9th Concession Road in the geographic township of Sandwich South, Town of Tecumseh. A plan showing the Shuttleworth Drain, as well as the general location of the bridges, enclosures, and drain is included herein as part of the report.

Our appointment and the works relative to the new and replacement bridges and enclosures and repair and improvements to the Shuttleworth Drain, proposed under this report, is in accordance with Section 78 of the “Drainage Act, R.S.O. 1990, Chapter D.17, as amended 2021”. We have performed all of the necessary survey, investigations, etcetera, for the proposed new and replacement bridges and enclosures, repairs, and improvements and we report thereon as follows.

II. BACKGROUND

From our review of the information provided from the Town's drainage files we have established the following reports that we utilized as reference for carrying out this project:

- 1) July 7th, 1967 Shuttleworth Drain C.G.R. Armstrong, P.Eng.

The 1967 report by C.G.R. Armstrong, P.Eng. provided for the construction of the Shuttleworth Drain and has the latest profile for the grading of the drain.

We arranged with the Town to provide us with the updated assessment roll information for the affected parcels. We also reviewed reports for the abutting drains and spoke to the owners to help in establishing the current watershed limit for the Shuttleworth Drain.

III. PRELIMINARY EXAMINATION AND ON-SITE MEETING

After reviewing all of the drainage information provided by the Town, we arranged with the former Town Drainage Superintendent Sam Paglia, P.Eng., to schedule an on-site meeting for November 9th, 2017. The following people were in attendance at said meeting: Mario Conciatori, Linda & Mark Shafer, David Gates, Mark Fishleigh (County of Essex), Sam Paglia (Town Drainage Superintendent), and Gerard Rood (Rood Engineering).

Details of the drain were discussed, and the primary concern was the condition of the access bridge to the lands of Gary and Linda Deneau. It was discussed that the whole drain is going to receive maintenance work including the bridges along the drain length that would be inspected and owners of the bridges would be contacted if there were concerns with any of the structures. Once the work scope is confirmed, a final report is then prepared and submitted to Council and goes through the Drainage Act process of a Consideration meeting and Court of Revision meeting.

Mr. Rood asked the Town and owners to provide information on any drainage changes that they might be aware of. The last report assessed most of the area immediately to the north of the drain.

It was discussed that all trees within the drain cross section from top of bank to top of bank will be removed to prevent obstruction of drainage. The south side of the drain will be basically cleared for access to carry out the work and dispose of material; however, some mature trees may be able to be saved if the Contractor can work around them. Material excavated along lawn areas will be done from the road side and will be trucked away. It was clarified that owners pay a portion of the cost if adjacent to the work area or upstream of the work.

Cost sharing of work to the bridges was discussed. Sam Paglia pointed out that the Town bears the cost for the drainage from North Talbot Road. The Town expects to hold a Public Information Centre meeting with the owners to review the Draft report and get their input and address their questions on the project. It was discussed that owners may debenture the cost of \$5,000.00 or greater for the drainage work over a 5 year period to reduce the immediate cost burden of their assessment for the work. There were some general discussions about private ditches and options that are available to the owners.

IV. FIELD SURVEY AND INVESTIGATIONS

Subsequent to the on-site meeting we arranged for a topographic survey of the drain and bridges to be completed. We further arranged to get updated assessment roll information from the Town and obtained information on the tax class of each of the properties affected by the Municipal Drain.

The Town made initial submissions to the Essex Region Conservation Authority (E.R.C.A.) regarding their requirements and investigations for any D.F.O. (Department of Fisheries and Oceans) requirements for work that would be proposed to be carried out on the Shuttleworth Drain. A response from the Conservation Authority was received by email on June 22nd, 2017 and indicated that the Town must apply for a permit and follow standard mitigation requirements. We also reviewed the Town maps for fish and mussel species at risk and find that there are no species indicated in the vicinity of this project. A copy of the concerns and requirements to satisfy E.R.C.A. and D.F.O. is included in **Appendix "REI-A"** of this report.

We also arranged to review the Ministry of Natural Resources & Forestry (M.N.R.F.) Species at Risk (S.A.R.) Mitigation Plan for Drainage Works (March 2018-17-4938) that the Town has prepared to address the Endangered Species Act, 2007. Section 6.0 of the Mitigation Plan indicates that snake species are a concern for this work area and although turtles are not indicated, they are mobile and could be encountered. The Mitigation Plan includes measures to be followed as outlined in "Section 7.0 Mitigation Measures" of the document and a copy of same as it relates to turtles and snakes is included in **Appendix "REI-B"**. Providing mitigation requirements are implemented, it was concluded that present wildlife Species at Risk will be protected from negative impacts and the works will not contravene Section 9 (species protection) or Section 10 (habitat protection) of the Endangered Species Act, 2007 now administered by the Ministry of Environment, Conservation and Parks (M.E.C.P.). Based on this information we find that the Town can proceed with the eligible repairs, maintenance and improvements to the drain as they are exempt under Sections 9 and 10 of the Act, provided that they follow the rules within Ontario Regulation 242/08 and the Mitigation Measures in their S.A.R. Mitigation Plan. To address these requirements the Town has established comprehensive mitigation measures as well as species identification guides for reference. Copies of the measures and guides shall be provided to the successful Tenderer for use during construction, and these documents are available for viewing by any interested parties at the Town office.

V. BRIDGES REVIEW

As part of our investigations, we made detailed inspections of all of the bridges along the open drain. Their condition and proposed work if any are summarized as follows:

1. This bridge enclosure serves parcel 540-00800 owned by Fabio Pace & Giselle Rossi. It was found to be in poor-fair condition, given no evidence of sink holes around the enclosure, although the C.S.P. (Corrugated Steel Pipe) ends are crushed and are beginning to rust through.
2. This bridge serves parcel 540-00701 owned by Gary & Linda Deneau. The bridge is in poor condition with both pipe ends being buried in the mud/gravel in addition to the bridge being fairly dated. The existing bridge is to be removed and the drain to be restored with the replacement bridge constructed at a new location as discussed with the owner.
3. This bridge serves parcel 540-00700 owned by the Town of Tecumseh. The bridge, comprised of corrugated steel pipe (C.S.P.), is a second access to the property located at its west limit, known as the 'Nature Trail', and is in poor-fair condition. The bridge currently experiences no active headwall protection, typical rusting, and crushed pipe ends. The bridge is to be replaced and should be replaced so that the standard minimum top width of 6.1 metres (20 feet) is provided and the pipe is set to the proposed profile grade of the drain.
4. This bridge also serves parcel 540-00700 owned by the Town of Tecumseh. The bridge is the primary access for the property which acts as a recreational site known as 'Weston Park'. The bridge, comprised of C.S.P., is in fair condition as it experiences typical rusting features in the pipe but has poor concrete block headwall features which are observed to be failing and falling into the drain. The existing bridge should be removed and replaced so that the new pipe is set to the new proposed profile grade line of the drain with new precast concrete block headwall protection.
5. This bridge serves parcel 540-00600 owned by Theresa Gates. The bridge is in okay-fair condition and comprises of C.S.P. During inspection it has been noted that the drain has been cleaned out at pipe ends, with typical rusting occurring, fair headwall conditions but an end failure may be present at the pipe downstream. In coordination with the other replacement bridges along the drain the existing bridge should be removed and replaced so that the new pipe is set to the new proposed profile grade line of the drain.
6. This bridge serves parcel 540-00500 owned by Robert and Peggy Weston. The bridge, comprised of C.S.P. is in fair condition with typical expected rusting, but features poor headwall conditions. In coordination with the other replacement bridges along the drain the existing bridge should be removed and replaced so that the new pipe is set to the new proposed profile grade line of the drain.
7. This bridge enclosure serves parcel 540-00400 owned by Amelia Conciatori. The bridge enclosure, comprised of C.S.P. and a C.S.P. catch basin in the middle, was in fair condition with typical associated rusting at the time of the survey. Recent inspections have revealed settlement occurring around the catch basin due to soil infiltration into the drain and the haunches of the pipe are completely rusted out in several areas that will result in sinkholes developing and collapse of the pipe. In coordination with the other replacement

bridges along the drain, the existing bridge enclosure should be removed and replaced so that the new pipe is set to the new proposed profile grade line of the drain and addresses the very poor condition of the existing C.S.P.

8. This bridge serves parcel 540-00360 owned by Emile & Marisa Nabbout. The bridge, comprised of C.S.P., is in poor condition and requires replacement as one end is buried. The existing bridge should be removed and replaced so that the new pipe is set to the new proposed profile grade line of the drain.
9. This bridge serves parcel 540-00340 owned by Ronnie & Rosa Dowhan. This bridge is in poor condition with no pipe visible at either upstream or downstream ends. In coordination with the other replacement bridges along the drain, the existing bridge should be removed and replaced so that the new pipe is set to the new proposed profile grade line of the drain.
10. This bridge serves parcel 540-00320 owned by Vittoria & Adam Fortier. This bridge comprised of C.S.P. is in fair condition. The existing pipe does not meet the minimal diameter requirements and should be removed and replaced so that the new pipe is sized accordingly and set to the new proposed profile grade line of the drain to prevent flow obstruction.
11. This bridge serves severed parcel 540-00303 owned by Timothy Kuhn & Sandra Vasquez. This bridge is a new access to the property near the west limit boundary and is comprised of C.S.P. The old pipe experiences the typical associated rusting and is in good condition. The existing pipe does not meet the minimal diameter requirements and should be removed and replaced so that the new pipe is sized accordingly and set to the new proposed profile grade line of the drain and is installed where the owners required it.
12. This bridge enclosure serves the east portion of parcel 540-00301 owned by John White, and all across the other lands being parcel 540-00300 owned by Ian Bristow, parcel 540-00200 owned by Thomas & Debra McGuinness, and parcel 540-00100 owned by Mark & Linda Shafer. The enclosure pipe appears to be in fair condition with no observed problems and can be replaced in the future with the appropriate size pipe under maintenance to the drain.

VI. PUBLIC INFORMATION CENTRE AND THE DRAINAGE ACT

Arrangements were made to meet virtually online on March 1st, 2022 with the Drainage Superintendent, Drainage Engineer and interested owners to discuss the Draft drainage report dated February 10th, 2022 for this project. There was a question regarding the scope of work and enclosures. Mr. Rood outlined the scope of work included in the P.I.C. report that was based on input at the on-site meeting and in subsequent follow-ups that owners had with the Town and Engineer. The differences between bridges and enclosures was explained with the requesting owners being responsible for any extra costs for an enclosure beyond the standard access bridge that each parcel is entitled to under the Drainage Act. Mr. Paglia went through the assessment schedule and explained what is included in each column with reference to the definitions as outlined below. The values in the schedule are an estimate of the cost for the work with the final cost to owners based on a ratio of the actual cost applied to the estimated values. The tendering

process is used to get the best price. Should the lowest tender exceed the report estimate of construction by 33% the Town sets up another meeting with the owners to review the details with options available. It was noted that the marketplace can vary. Mr. Rood explained the life of H.D.P.E. pipe with its cost being an investment that enhances the parcel values for the 75 to 100 year typical life expectancy.

A question was brought up on how assessments are paid. Mr. Paglia outlined how work under the Drainage Act is separate from typical municipal taxes. Drainage work is a communal project serving the affected lands. No grants from O.M.A.F.R.A. are expected for this project. The final cost of the project goes to Council for review and is then billed out. When an assessment is over \$5,000.00 to a parcel, the owner(s) may elect to debenture the cost for 5 or 10 years at current interest costs. An owner can decide to pay all the bill or decide to spread out the costs over a longer period.

There was a concern that the work is too expensive, and it may be preferred to delay it with questions on the sharing of cost and not necessarily seeing the benefit. Mr. Paglia explained that the Town has to maintain the drain and restore it and that we will not be creating any new works. The Engineer has to recommend the pipe replacements if the pipe is bad, and it is time to do it now. The Town has the duty to do the work. There is a lot of benefits to have a working drain in place. All owners have a responsibility to maintain flows in the drain and it is Council's obligation to keep drains working. Owners may have their own opinions, but Council has to decide on whether to proceed. The pricing can be high, but no work has been done on the drain for almost 55 years. There are many ways to look at the drain, but they have to follow the Drainage Act. The intent is to treat everyone equally and the Town has a big bill for the road and for their parkland with their costs paid from the general tax levy. Apportionments are based on the parcels use and features with upstream owners typically having a bit higher cost sharing to get their water to a sufficient outlet per Common Law. The report includes cost sharing for the bridges and the open drain work is also shared by all lands using it. Works on downstream drains is also assessed to upstream affected lands and roads.

There was a question on how costly the work was. Mr. Rood explained the factors that are considered in establishing the cost estimates. Mr. Paglia pointed out that comparing cost for one parcel to another is indicating that the costs are accurate based on the ratio of lengths of bridges. In response to a question about pipe end treatments, Mr. Paglia described the end treatments and that rock on filter cloth is typically the most cost effective for a drain of this size. If a more fancy end treatment is desired, the owner is typically assessed for the extra cost associated with same. When asked about possible impact on property taxes, Mr. Paglia explained that drainage works do not affect the general tax levy and explained a block assessment, but this is not applied on this project. The MPAC does not consider drainage in land evaluation, and we are just fixing the existing drain under this project. When asked if there was any future work for trails and costs, he replied that he is not aware of any works. If a road needs to improve the drain, they pay all the costs for it. Developers can be responsible for extra costs. It was noted that there is a major development near the 8th Concession Road. Mr. Paglia stated that the development does not go into the Shuttleworth Drain and will be using the Washbrook Drain and will have similar

responsibilities for that drain. He noted that Deneau and White will be responsible for extra costs due to their severances and those owners also share in the total drainage work costs.

There was a question about future enclosure of the drain and Mr. Rood explained the factors that will need to be considered at that time. Mr. Paglia noted that another drainage report would have to be done for a future enclosure with additional costs and this project cannot be delayed too long since appeals can be made. An owner can request changes at this time and all additional costs would go to the owner that requests changes. Extending an enclosure would have similar costs per metre as the estimates. The owners asked about quotation of costs and Mr. Paglia advised them that Mr. Rood could get this for them if they make a request and they would have to provide written approval to proceed with the extra work being requested. Once the request is made for extra enclosure it becomes part of the by-law for the work to the drain and cannot be abandoned later since the by-law must be followed. The owners were advised to contact Mr. Paglia or Mr. Rood with any requests and any extra works requested in writing will be included in the final drainage report that will go to Council for the Consideration of the drainage report with all affected owners participating.

Benefit and Outlet liability assessments were discussed as defined below. Establishment of pipe lengths is based on the minimum standard top width of 6.1m (20'), the depth of the drain and the type of end treatment provided. The cost of additional top width requested by an owner is fully borne by that owner. The owners are reminded that the drainage report provides estimates of costs, and the owners will only pay the actual cost shared on the basis of the assessment schedule. Lands eligible for the farm property tax class rate will be eligible for a grant in the amount of 1/3 of their total cost assessment but no parcels are expected to qualify for this. All of the cost for new access bridges and enclosures will be fully assessed to the lands served by the bridge and enclosure. Following construction of the bridge and enclosure, any future maintenance that is required will be shared by the parcel served by the bridge and upstream lands and roads as set out in the bridge cost sharing table of this drainage report with all increased cost for the enclosure being assessed to the lands served by same.

The Town hopes to have the project approved by the end of May. The fish protection timing window from March 15 to June 30th will come into effect and the work will have to be done after June 30th. Bridge and enclosure cost sharing will be reviewed with the owners if they have any questions.

It should be noted that the Public Information Centre (P.I.C.) meeting is not a requirement under the Drainage Act but the Town holds these meetings to address questions and concerns and to solicit comments from the affected owners and receive any requests for modifications to the scope of work.

Owners are reminded that they have the opportunity to present their concerns to Council regarding the report details at the Consideration meeting and assessment questions at the Court of Revision meeting, along with appeal rights to the Ontario Ministry of Agriculture, Food and

Rural Affairs (O.M.A.F.R.A.) Appeals Tribunal and to the Drainage Referee as provided for in the Drainage Act.

The Drainage Act definitions and applicable clarifications are as follows:

“Benefit” means the advantages to any lands, roads, buildings or other structures from the construction, improvement, repair, or maintenance of a drainage works such as will result in a higher market value or increased crop production or improved appearance or better control of surface or subsurface water, or any other advantages relating to the betterment of lands, roads, buildings, or other structures.

“Outlet liability” means the part of the cost of the construction, improvement or maintenance of a drainage works that is required to provide such outlet or improved outlet. Lands and roads that use a drainage works as an outlet, or for which, when the drainage works is constructed or improved, an improved outlet is provided either directly or indirectly through the medium of any other drainage works or of a swale, ravine, creek, or watercourse, may be assessed for outlet liability. The assessment for outlet liability shall be based upon the volume and rate of flow of the water artificially caused to flow upon the injured land or road or into the drainage works from the lands and roads liable for such assessments. Every drainage works constructed under this Act shall be continued to a sufficient outlet.

Owners are advised that they have a legal responsibility to convey their drainage to a sufficient outlet. For this reason, they have a share in the cost for upkeep of the drain downstream of their lands and this obligation is reflected in the assessment for Outlet Liability. Owners are reminded that the responsibility for carrying out maintenance on a Municipal drain rests with the Town as set out in the Drainage Act. Any owner can notify the Town that the drain requires maintenance, and the Town has to take action pursuant to the Act. This system is generally reactive and requires the property owners to raise their concerns and issues to the Town. Owners are reminded that keeping brush clear along their portion of the drain and having buffer strips provides them with a direct benefit of reduced maintenance costs for the drain. Owners have an Outlet Liability for the downstream portion of the drain. The owners are reminded that Municipal drainage is a communal project and basically a user pay system.

Owners may appeal their assessment as set out in the drainage report. They are advised that they should submit their appeal to the Court of Revision at least 10 days before the scheduled date of the meeting; however, the Court of Revision can agree to hear appeals presented at the meeting. If owners are still dissatisfied with the report after that meeting, they may submit an appeal to the O.M.A.F.R.A. Appeals Tribunal through the Town Clerk within 21 days of the closing of the Court of Revision pursuant to Section 54 of the Drainage Act.

The cost sharing for bridges is based on the location of same along the overall length of the drainage system. Each owner has the right for one access across each Municipal drain. The owner generally pays 100% of the cost for the first bridge installation and it becomes part of the drain

when included in an engineer's report and is then to be maintained by the drain with future costs shared as set out in the drainage report.

Owners should be aware that existing grass buffers and accesses will be protected and maintained as set out in the report specifications. Allowances as set out in the report are to offset damages to lands from the construction work and excavated material disposal. Owners are advised that the Contractor is responsible to remove any sticks and rocks (cobbles) etcetera from the spread materials and the Contractor is responsible to guarantee the work performed on the drain with a maintenance period of one year from the date of substantial completion.

VII. FINDINGS AND RECOMMENDATIONS

We find that the profile included in the 1967 report plans by engineer C.G.R. Armstrong provides a good fit to the existing west profile of the drain. Said report provided for the construction of the open drain portion that still appears to suit the current conditions of the watershed. Based on our detailed survey, investigations, examinations, and discussions with the affected Owners and governing Authorities, we would recommend that drain improvement works be carried out as follows:

- a) We recommend that all drain improvements, be carried out in accordance with the requirements established by E.R.C.A. and D.F.O. as set out in the documents within **Appendix "REI-A"** attached to this report.
- b) As this is an existing Municipal drain, and conditions have not changed and there is no information to indicate any new species concerns, the repair and improvement can be carried out based on the provisions included within the Town "S.A.R. Mitigation Plan for Drainage Works" and the mitigation measures included within same. A copy of said mitigation measures is included in **Appendix "REI-B"** within this report. We recommend that any work being completed shall be carried out in accordance with provisions as included in **Appendix "REI-B"** for reference by the land owners, the Town of Tecumseh, and the Contractor who will be conducting the works.
- c) We find that portions of the open drain have significant accumulation of silt and debris and we recommend that these be cleaned out as set out further in this report. The drain portion west of the Talbot McCarthy Drain will have the same 0.16% grade as set out in the Armstrong report plans, while the portion west of the Talbot McCarthy Drain will be repaired and improved to the design grade shown on the profile in the attached plans. The Enclosure 12 at the east end of the drainage works shall be repaired and improved in the future with the replacement pipe set to match the existing pipe grades.
- d) As provided for by Section 18 of the Drainage Act, we recommend that the bridges and enclosures along the drain be repaired and improved as outlined further in this report including the specifications and the plans that form part of the report.

- e) The existing drain has some buffer strips and grass areas along the Municipal drain that reduce the amount of erosion and the sediment entering the drain and enhance water quality. We recommend that the existing grass areas and buffer strips be protected as part of this project and recommend that new buffer strips with a minimum width of 1.0 metre be constructed as part of the works in all areas where no current grass buffer exists.
- f) No concerns were brought forward or seen for the enclosed portion at the east end. We recommend that the corrugated steel pipe covered drain Enclosure 12 be replaced with 375mm diameter 320 kPa H.D.P.E. smooth wall pipe when future maintenance is required with cost assessed on a frontage basis for the pipe length across each parcel as outlined in the Bridge Cost Sharing table below. Work shall include sloped quarried limestone on filter cloth end treatments as set out in the attached specifications and appendices that form part of this report.
- g) Subsequent to the on-site meeting, the Town and some owners advised us of new bridges required for requested severances to their lands. Details for the required bridges were provided and these have been included in this report for making them part of the drainage works and providing the Town with the information required for future maintenance.
- h) Following the P.I.C. meeting, written requests were received from three landowners for providing enclosures along their frontage. The plans and estimates had been updated for Bridges and Enclosures 8, 9 and 10 including adjustments to the assessment schedule. Subsequent to the Court of Revision meeting, the owners have now contacted the Town and our office and provided written instructions that they just want a standard access bridge provided for their parcels with reduction in the construction cost and updates to reduce their cost sharing that is provided below.
- i) M.E.C.P. requires proper handling of excess soils in accordance with Ontario Reg 406/19 pursuant to the Environmental Protection Act, R.S.O. 1990, c. E.19 and any subsequent amendments to same. In liaison with the Town Drainage Department, we arranged for the necessary investigations and testing by WSP E&I Canada Limited. Their report and findings are included in **Appendix "REI-F"** attached to this report. We recommend that handling of all excavated materials including disposal be carried out in accordance with the requirements set out in the WSP report.

We recommend that the Shuttleworth Drain be repaired and improved, and the new and replacement bridges and enclosures and future east end enclosure replacement be installed, in accordance with this report, the attached specifications and the accompanying drawings, using the design grades shown on the attached profile plans, and that all works associated with same be carried out pursuant to Section 78 of the "Drainage Act, R.S.O. 1990, Chapter D.17 as amended 2021".

VIII. ALLOWANCES

We have provided that all of the work will generally be completed from the south side of the drain. The Contractor will be required to restore any existing grassed buffer and driveway areas damaged by the work. We recommend that any materials removed from the open drain or existing bridges and enclosures, be loaded up and hauled away for disposal by the Contractor or placed beyond the limits of any existing grass buffer or driveway access should an owner desire same. Based on all of the above we find that allowances for damages are payable pursuant to Sections 29 and 30 of the Drainage Act.

We find that the provision of access along the south bank of the drain and disturbance to the abutting lands requires payment for the land necessary to carry out the work along the drain. We therefore recommend that the following owners be compensated for all work areas that will be impacted, including for the access to the drain and for damages to lawn areas, drain banks and grass buffers as follows, namely:

1)	John White, (540-00301),	Owner,	Part of Lot 10 & 11, N.T.R. Concession,	\$	55.00
2)	Timothy Kuhn & Sandra Vasquez, (540-00303),	Owners,	Part of Lot 10 & 11, N.T.R. Concession,	\$	55.00
3)	Adam and Vittoria Fortier, (540-00320),	Owners,	Part of Lot 10 & 11, N.T.R. Concession	\$	80.00
4)	Ronnie & Rosa Dowhan, (540-00340),	Owners,	Part of Lot 10 & 11, N.T.R. Concession	\$	60.00
5)	Emile & Marisa Nabbout, (540-00360),	Owners,	Part of Lot 10 & 11, N.T.R. Concession	\$	60.00
6)	Amelia Conciatori, (540-00400)	Owner,	Part of Lot 10 & 11, N.T.R. Concession	\$	90.00
7)	Robert & Peggy Weston, (540-00500)	Owners,	Part of Lot 11, N.T.R. Concession	\$	120.00
8)	Theresa Gates, (540-00600)	Owner,	Part of Lot 11, N.T.R. Concession	\$	110.00
9)	Weston Park, Town of Tecumseh, (540-00700)	Owner,	Part of Lot 11, N.T.R. Concession	\$	260.00
10)	Fabio Pace & Giselle Rossi, (540-00800)	Owners,	Part of Lot 11, N.T.R. Concession	\$	230.00

Reconsidered Report - Shuttleworth Drain E09SH(88)
(Geographic Township of Sandwich South)
Town of Tecumseh - REI2017D020

2023-08-21

11)	Gary & Linda Deneau (540-00701)	Owners,	Part of Lot 11, N.T.R. Concession	\$	240.00
TOTAL FOR ALLOWANCES AND DAMAGES					\$ 1,360.00

These values for allowances and damages are based on a strip of land parallel to and immediately adjacent to the drain or grassed buffer and driveway, for the parcels abutting the north side of the Municipal drain and are based on a value of \$1,225.00 per acre (\$3,027.00 per hectare) for the affected lands. Since grass seed restoration can take some time to bring affected areas back to original conditions, these allowances are calculated using a rate per acre of \$700.00 for year one, \$350.00 for year two and \$175.00 for the third year, similar to allowances for damages to lands and crops of agricultural parcels. These allowances will offset costs that owners may incur for watering, fertilizing, and adding additional grass seed if deemed necessary. The impact after 3 years is considered negligible.

We have provided for this in our estimate as is provided for under Sections 29 and 30 of the "Drainage Act, R.S.O. 1990, Chapter D.17, as amended 2021".

IX. ESTIMATE OF COST

Our estimate of the Total Cost of this work, including all incidental expenses, is the sum of **TWO HUNDRED SIXTY SIX THOUSAND FIVE HUNDRED DOLLARS (\$266,500.00)**, made up as follows:

CONSTRUCTION

Item 1)	<u>Station 0+000 to Station 0+750;</u> Carry out excavation of the drain to remove accumulated sediment and restore the drain to the profile grade shown on the plans, including all disposal, hauling, and leveling of material, approximately 750 lineal metres (approximately 340 cubic metres).	Lump Sum	\$	13,600.00
Item 2)	<u>Station 0+000 to Station 0+750;</u> Supply and install new heavy duty H.D.P.E. plastic tile main extensions, including connections, rodent grate, removal of any deleterious materials, excavation, backfill, compaction and restoration, complete:			
	a) 3.0 metres (10') of 150mm (6") diameter pipe for 150mm diameter tiles: <u>1</u> required at <u>\$300.00</u> each		\$	300.00

Reconsidered Report - Shuttleworth Drain E09SH(88)
(Geographic Township of Sandwich South)
Town of Tecumseh - REI2017D020

2023-08-21

- | | | | | |
|---------|--|----------|----|-----------|
| Item 3) | <u>Station 0+000 to Station 0+750;</u> Brushing and grubbing including all disposal and clean up (approximately 750 lineal metres), removing and reinstalling fences, complete. | Lump Sum | \$ | 11,250.00 |
| Item 4) | <u>Station 0+000 to Station 0+750;</u> Spread scavenged topsoil; carry out seeding and mulching on all newly excavated side slopes including all harrowing, raking, preparation and clean up, approximately 4,500 square metres, complete. | Lump Sum | \$ | 18,000.00 |
| Item 5) | <u>Bridge No. 1 (Enclosure);</u> Excavate drain, completely remove enclosure and dispose of the existing pipe, sediment and all endwall materials, including any other deleterious material encountered; supply and install <u>60</u> metres of 450mm diameter, H.D.P.E. smooth wall Boss 2000 plastic pipe including Granular 'B' backfill, Granular 'A' travel surface; excavation, placement, compaction, grading; 305mm thick quarried limestone on filter cloth sloped end protection; topsoil placement, seeding and mulching, and restoration and clean up, complete.
(Fabio Pace & Giselle Grossi) | Lump Sum | \$ | 29,700.00 |
| Item 6) | <u>Bridge No. 2;</u> Excavate drain, completely remove and dispose of the existing pipe, sediment and all endwall materials, including any other deleterious material encountered; supply and install <u>13</u> metres of 450mm diameter, H.D.P.E. smooth wall Boss 2000 plastic pipe including Granular 'B' backfill, Granular 'A' travel surface; excavation, placement, compaction, grading; 305mm thick quarried limestone on filter cloth sloped end protection; topsoil placement, seeding and mulching, and restoration and clean up, complete.
(Gary & Linda Deneau) | Lump Sum | \$ | 10,400.00 |
| Item 7) | <u>Bridge No. 2A;</u> Excavate drain, completely remove and dispose of the existing sediment and all unsuitable materials, including any other deleterious material encountered; supply and install <u>10</u> metres of 450mm diameter, H.D.P.E. smooth wall Boss 2000 plastic pipe including Granular 'B' backfill, Granular 'A' travel surface; excavation, placement, compaction, grading; 305mm thick quarried limestone on filter cloth sloped end | | | |

Reconsidered Report - Shuttleworth Drain E09SH(88)
(Geographic Township of Sandwich South)
Town of Tecumseh - REI2017D020

2023-08-21

	protection; topsoil placement, seeding and mulching, and restoration and clean up, complete. (Linda Deneau)	Lump Sum	\$	8,700.00
Item 8)	Bridge No. 3; Excavate drain, completely remove and dispose of the existing pipe, sediment and all endwall materials, including any other deleterious material encountered; supply and install <u>10</u> metres of 450mm diameter, H.D.P.E. smooth wall Boss 2000 plastic pipe including Granular 'B' backfill, Granular 'A' travel surface; excavation, placement, compaction, grading; 305mm thick quarried limestone on filter cloth sloped end protection; topsoil placement, seeding and mulching, and restoration and clean up, complete. (Weston Park, Town of Tecumseh)	Lump Sum	\$	8,000.00
Item 9)	Bridge No. 4; Excavate drain, completely remove and dispose of the existing pipe, sediment and all endwall materials, including any other deleterious material encountered; supply and install <u>8</u> metres of 450mm diameter, H.D.P.E. smooth wall Boss 2000 plastic pipe including Granular 'B' backfill, Granular 'A' travel surface; excavation, placement, compaction, grading; 600mm x 600mm x 1200mm precast concrete block end protection; topsoil placement, seeding and mulching, and asphalt driveway restoration and clean up, complete. (Weston Park, Town of Tecumseh)	Lump Sum	\$	17,300.00
Item 10)	Bridge No. 5; Excavate drain, completely remove and dispose of the existing pipe, sediment and all endwall materials, including any other deleterious material encountered; supply and install <u>12</u> metres of 450mm diameter, H.D.P.E. smooth wall Boss 2000 plastic pipe including Granular 'B' backfill, Granular 'A' travel surface; excavation, placement, compaction, grading; 305mm thick quarried limestone on filter cloth sloped end protection; topsoil placement, seeding and mulching, and restoration and clean up, complete. (Theresa Gates)	Lump Sum	\$	7,800.00
Item 11)	Bridge No. 6; Excavate drain, completely remove and dispose of the existing pipe, sediment and all endwall materials, including any other deleterious material encountered; supply and install <u>11</u> metres of 450mm			

	diameter, H.D.P.E. smooth wall Boss 2000 plastic pipe including Granular 'B' backfill, Granular 'A' travel surface; excavation, placement, compaction, grading; 305mm thick quarried limestone on filter cloth sloped end protection; topsoil placement, seeding and mulching, and restoration and clean up, complete. (Robert Weston)	Lump Sum	\$	7,600.00
Item 12)	Bridge No. 7 (Enclosure); Excavate drain, completely remove enclosure and dispose of the existing pipe, sediment and all east endwall materials, including any other deleterious material encountered; supply and install <u>38</u> metres of 450mm diameter, H.D.P.E. smooth wall Boss 2000 plastic pipe including precast concrete catch basin and cast iron frame and grate, adjustment risers and pipe connections, Granular 'B' backfill and Granular 'A' travel surface at driveway; excavation, placement, compaction, grading; 305mm thick quarried limestone on filter cloth sloped end protection; native backfill and topsoil placement, seeding and mulching, and asphalt driveway restoration and clean up, complete. (Amelia Conciatori)	Lump Sum	\$	17,200.00
Item 13)	Bridge No. 8; Excavate drain, completely remove and dispose of the existing pipe, sediment and all endwall materials, including any other deleterious material encountered; restore the drain cross section; topsoil placement, seeding and mulching, and restoration and clean up; at new location install <u>12.0</u> metres of 450mm diameter, H.D.P.E. smooth wall Boss 2000 plastic pipe including Granular 'B' backfill, Granular 'A' travel surface; excavation, placement, compaction, grading; 305mm thick quarried limestone on filter cloth sloped end protection; topsoil placement, seeding and mulching, and asphalt driveway restoration and clean up, complete. (Emile & Marisa Nabbout)	Lump Sum	\$	9,600.00
Item 14)	Bridge No. 9; Excavate drain, completely remove and dispose of the existing pipe, sediment and all endwall materials, including any other deleterious material encountered; restore the drain cross section; topsoil placement, seeding and mulching, and restoration and clean up; at new location install <u>12.0</u> metres of 450mm diameter, H.D.P.E. smooth wall Boss 2000 plastic pipe			

	including Granular 'B' backfill, Granular 'A' travel surface; excavation, placement, compaction, grading; 305mm thick quarried limestone on filter cloth sloped end protection; topsoil placement, seeding and mulching, and asphalt driveway restoration and clean up, complete. (Ronnie & Rosa Dowhan)	Lump Sum	\$	9,400.00
Item 15)	Bridge No. 10; Excavate drain, completely remove and dispose of the existing pipe, sediment and all endwall materials, including any other deleterious material encountered; restore the drain cross section; topsoil placement, seeding and mulching, and restoration and clean up; at new location install <u>11.0</u> metres of 450mm diameter, H.D.P.E. smooth wall Boss 2000 plastic pipe including Granular 'B' backfill, Granular 'A' travel surface; excavation, placement, compaction, grading; 305mm thick quarried limestone on filter cloth sloped end protection; topsoil placement, seeding and mulching, and asphalt driveway restoration and clean up, complete. (Adam & Vittoria Fortier)	Lump Sum	\$	9,100.00
Item 16)	Bridge No. 11; Excavate drain, completely remove and dispose of the existing pipe, sediment and all endwall materials, including any other deleterious material encountered; restore the drain cross section; topsoil placement, seeding and mulching, and restoration and clean up; at new location install <u>11</u> metres of 450mm diameter, H.D.P.E. smooth wall Boss 2000 plastic pipe including Granular 'B' backfill, Granular 'A' travel surface; excavation, placement, compaction, grading; 305mm thick quarried limestone on filter cloth sloped end protection; topsoil placement, seeding and mulching, and driveway restoration and clean up, complete. (Timothy Kuhn & Sandra Vasquez)	Lump Sum	\$	7,200.00
Item 17)	Bridge No. 12 (Enclosure); Carry out flushing and cleaning of enclosure at east end including all loading, hauling, disposal, clean up and restoration, complete.	Lump Sum	\$	1,650.00
Item 18)	Complete final clean up and restoration of all work areas affected by the project.	Lump Sum	\$	1,000.00

Reconsidered Report - Shuttleworth Drain E09SH(88)
(Geographic Township of Sandwich South)
Town of Tecumseh - REI2017D020

2023-08-21
Addendum: 2023-10-02

Item 19)	Estimated net Harmonized Sales Tax (1.76% H.S.T.) on construction items above.	Lump Sum	\$	3,332.00
Item 20)	Contingency amount for construction including any extra costs for material handling in accordance with Excess Soil regulations.	Lump Sum	\$	16,468.00
TOTAL FOR CONSTRUCTION			\$	207,600.00

INCIDENTALS

1)	Report, Estimate, & Specifications		\$	11,200.00
2)	Survey, Assistants, Expenses, Drawings, Duplication Cost of Report and Drawings, Consideration Meeting, etc.		\$	23,800.00
3)	Estimated Cost of Preparing Tender Documents		\$	900.00
4)	Estimated Cost of Construction Supervision and Inspection (based on 10 days)		\$	8,000.00
5)	Estimated Net H.S.T. on Items Above (1.76%)		\$	773.00
6)	Estimated Cost of E.R.C.A. permit		\$	500.00
7)	Estimated Cost of Environmental Investigations to Address Excess Soils		\$	6,700.00
8)	Estimated Cost of Interim Financing		\$	500.00
9)	Estimated Contingency Allowance		\$	5,167.00
TOTAL FOR INCIDENTALS			\$	57,540.00
TOTAL FOR ALLOWANCES (brought forward)			\$	1,360.00
TOTAL FOR CONSTRUCTION (brought forward)			\$	207,600.00
TOTAL ESTIMATE			\$	266,500.00

X. DRAWINGS AND SPECIFICATIONS

As part of this report, we have attached design drawings for the construction of the new and replacement bridges, enclosures and drain improvements. The design drawings show the subject improvement locations and the details of the work, as well as the approximate location within the watershed area. The drain design drawings are attached to the back of this report and are labelled **Appendix "REI-E"**.

Also attached, we have prepared Specifications which set out the required construction details for the drain repair and improvements, which also include Standard Specifications labelled therein as **Appendix "REI-C"**.

XI. CONSTRUCTION SCHEDULE OF ASSESSMENT

We would recommend that all of the costs associated with the construction of the drain repair and improvements, and the preparation of this Engineer's report, be assessed against the affected lands in the geographic township of Sandwich South, Town of Tecumseh. A Schedule of Assessment has been prepared and included herein to indicate the lands assessed for the repair and improvement of the drain and bridges. The Schedule of Assessment includes a Special Benefit assessment to each parcel that is having their bridge/enclosure repaired and improved or a new bridge installed under this report. The new bridge is assessed 100% to the parcel and owners served by the new bridge.

Pursuant to the current Agricultural Drainage Infrastructure Program (A.D.I.P.) Policies that are in place, it is anticipated that the lands are eligible for a grant from the Ontario Ministry of Agriculture, Food and Rural Affairs (O.M.A.F.R.A.) in the amount of 1/3 of their total assessment for this project if they are agricultural lands designated as Farm Property Tax Class Rate. Where a bridge structure has increased top width beyond the standard 6.10 metre (20.0 ft.) top width, all of the increased costs resulting from same are assessed 100% to the Owner, as provided for in the cost sharing set out in the attached Table below and the Schedule of Assessment.

XII. FUTURE MAINTENANCE

When maintenance work is carried out in the future on the open drain portion, the cost for said future maintenance shall be assessed in accordance with the attached Schedule of Assessment excluding any Special Benefit. When future maintenance work is carried out, the assessment to the affected Owners shall be based on the actual future maintenance cost shared on a pro-rata basis with the Benefit and Outlet values shown in this assessment schedule.

When maintenance work is carried out on any bridges and enclosures in the future, we recommend that part of the cost be assessed as a Benefit to the abutting parcel served by the

access bridge and enclosure, and the remainder shall be assessed to the upstream lands and roads based on their affected area and Outlet Liability assessments on a pro-rata basis as set out in the attached Schedule of Assessment. The share for Benefit and Outlet Liability for future maintenance shall be as set out in the Bridge Cost Sharing table below.

BRIDGE COST SHARING

<u>Bridge</u>	<u>Owners</u>	<u>Benefit to Owner</u>	<u>Outlet Upstream</u>
1	Fabio Pace & Giselle Rossi, (540-00800),	91.2%	8.8%
2	Gary & Linda Deneau, (540-00701),	85.7%	14.3%
2A	Linda Deneau, (540-00703),	85.7%	14.3%
3	Town of Tecumseh, (540-00700),	100.0%	0.0%
4	Town of Tecumseh, (540-00700),	85.5%	14.5%
5	Theresa Gates, (540-00600),	80.7%	19.3%
6	Robert & Peggy Weston, (540-00500),	79.6%	20.4%
7	Amelia Conciatori, (540-00400),	92.5%	7.5%
8	Emile & Marisa Nabbout (540-00360),	83.3%	16.7%
9	Ronnie & Rosa Dowhan, (540-00340),	85.8%	14.2%
10	Adam & Vittoria Fortier, (540-00320),	84.2%	15.8%
11	Timothy Kuhn & Sandra Vasquez, (540-00303),	85.0%	15.0%

Reconsidered Report - Shuttleworth Drain E09SH(88)
(Geographic Township of Sandwich South)
Town of Tecumseh - REI2017D020

2023-08-21

12	John White, (540-00301),	20.9%	0.0%
	Ian Bristow, (540-00300),	33.8%	
	Thomas & Debra McGuinness, (540-00200),	28.7%	
	Mark & Linda Shafer, (540-00100),	16.6%	

We recommend that the bridge structures and enclosures as identified herein, and the covered portion at the east end be maintained in the future as part of the drainage works by the Town of Tecumseh. The cost for a standard access bridge with a 6.1m (20 foot) top width is shared between the parcel served by the bridge as a Benefit and to upstream lands and roads as Outlet Liability based on the location of the structure relative to its position along the drain length. Where a bridge pipe or enclosure exceeds the length required for a standard access bridge, all of the increase in cost for the extra pipe, backfill and associated work is assessed 100% to the parcel that is served by the bridge pipe or enclosure as part of the Benefit assessed to same and shown as a Special Benefit in the attached Schedule of Assessment. Bridge 3 is a secondary access to the Town parklands and a secondary access is assessed 100% to the lands that it serves with only the primary access bridge costs shared between the parcel that it serves and the upstream lands and roads. For Enclosure 12 at the east end of the drainage works, and that flows from west to east, there is no upstream flows contributed and the cost sharing is therefore based on the abutting lands that Benefit from the Enclosure being in place along those lands, accounting for the length of enclosure pipe serving each parcel.

We would also recommend that the bridges and enclosures, for which the maintenance costs are to be shared with the upstream lands and roads within the watershed, be maintained by the Town and that said maintenance would include works to the bridge culvert, bedding, backfill and end treatment. Should concrete, asphalt, or other decorative driveway surfaces over these bridge culverts and enclosures require removal as part of the maintenance works, these surfaces shall also be repaired or replaced as part of the works. Likewise, if any fencing, gate, decorative walls, guardrails, or other special features exist that will be impacted by the maintenance work, they are also to be removed and restored or replaced as part of the bridge or enclosure maintenance work. However, the cost of the supply and installation of any surface materials other than Granular "A" material and the cost of removal and restoration or replacement, if necessary, of any special features, shall be totally assessed to the benefiting adjoining Owner(s) served by said access bridge or enclosure. We recommend that the cost for maintenance and repair and improvement for the covered portion of the drain at the east end shall be assessed to the abutting owners based on the parcel frontage adjacent to the covered drain portion as illustrated in the Bridge Cost Sharing table above.

We further recommend that the maintenance cost sharing as set out above shall remain as aforesaid until otherwise determined and re-established under the provisions of the "Drainage Act, R.S.O. 1990, Chapter D.17 as amended 2021".

Reconsidered Report - Shuttleworth Drain E09SH(88)
(Geographic Township of Sandwich South)
Town of Tecumseh - REI2017D020

2023-08-21

All of which is respectfully submitted.

Rood Engineering Inc.



Gerard Rood, P.Eng.

tm

att.

Rood Engineering Inc.

Consulting Engineers
9 Nelson Street
LEAMINGTON, Ontario N8H 1G6



SCHEDULE OF ASSESSMENT
SHUTTLEWORTH DRAIN - RECONSIDERED REPORT
Town of Tecumseh

3. MUNICIPAL LANDS:

Tax Roll No.	Con. or Plan No.	Lot or Part of Lot	Acres Owned	Acres Afft'd	Hectares Afft'd	Owner's Name	Value of Benefit	Value of Outlet	Value of Special Benefit	TOTAL VALUE
		North Talbot Road		2.00	0.809	Town of Tecumseh	\$ 38,303.00	\$ 2,799.00	\$ 1,596.00	\$ 42,698.00
Total on Municipal Lands.....							\$ 38,303.00	\$ 2,799.00	\$ 1,596.00	\$ 42,698.00

4. PRIVATELY OWNED - NON-AGRICULTURAL LANDS:

Tax Roll No.	Con. or Plan No.	Lot or Part of Lot	Acres Owned	Acres Afft'd	Hectares Afft'd	Owner's Name	Value of Benefit	Value of Outlet	Value of Special Benefit	TOTAL VALUE
540-00100	8	S PT LOT 10	0.28	0.14	0.057	Mark & Linda Shafer	\$ 564.00	\$ 143.00	\$ -	\$ 707.00
540-00200	8	S PT LOT 10	0.57	0.29	0.115	Thomas & Debra McGuiness	\$ 1,147.00	\$ 247.00	\$ -	\$ 1,394.00
540-00300	8	S PT LOT 10	0.66	0.33	0.133	Ian Bristow	\$ 1,326.00	\$ 277.00	\$ -	\$ 1,603.00
540-00301	8	PT LOT 10 & 11	1.21	0.60	0.244	John White	\$ 2,425.00	\$ 414.00	\$ -	\$ 2,839.00
540-00303	8	PT LOT 10 & 11	0.74	0.37	0.149	Timothy Kuhn & Sandra Vasquez	\$ 1,410.00	\$ 300.00	\$ 9,196.00	\$ 10,906.00
540-00320	8	PT LOTS 10 & 11	1.16	0.58	0.235	Adam & Vittoria Fortier	\$ 2,222.00	\$ 428.00	\$ 9,786.00	\$ 12,436.00
540-00340	8	PT LOTS 10 & 11	1.07	0.53	0.216	Ronnie & Rosa Dowhan	\$ 2,041.00	\$ 393.00	\$ 10,301.00	\$ 12,735.00
540-00360	8	PT LOTS 10 & 12	1.17	0.58	0.236	Emile & Marisa Nabbout	\$ 2,236.00	\$ 431.00	\$ 10,213.00	\$ 12,880.00
540-00400	8	PT LOTS 10 & 13	2.57	1.28	0.520	Amelia Conciatori	\$ 4,922.00	\$ 687.00	\$ 20,320.00	\$ 25,929.00
540-00500	8	S PT LOT 11	3.10	1.55	0.628	Robert & Peggy Weston	\$ 5,941.00	\$ 750.00	\$ 7,726.00	\$ 14,417.00
540-00600	8	S PT LOT 11	2.77	1.39	0.561	Theresa Gates	\$ 5,306.00	\$ 740.00	\$ 8,039.00	\$ 14,085.00
540-00700	8	S PT LOT 11	9.00	4.50	1.822	Town of Tecumseh	\$ 17,244.00	\$ 1,146.00	\$ 29,108.00	\$ 47,498.00

**Shuttleworth Drain Reconsidered E09SH(88)
Town of Tecumseh**

Tax Roll No.	Con. or Plan No.	Lot or Part of Lot	Acres Owned	Acres Afft'd	Hectares Afft'd	Owner's Name	Value of Benefit	Value of Outlet	Value of Special Benefit	TOTAL VALUE
540-00701	8	S PT LOT 11	1.42	0.71	0.287	Gary & Linda Deneau	\$ 2,720.00	\$ 470.00	\$ 11,383.00	\$ 14,573.00
540-00703	8	S PT LOT 11	1.42	0.71	0.287	Linda Deneau	\$ 2,720.00	\$ 470.00	\$ 11,111.00	\$ 14,301.00
540-00800	8	S PT LOT 11	1.29	0.64	0.260	Fabio Pace & Giselle Rossi	\$ 2,463.00	\$ 442.00	\$ 34,594.00	\$ 37,499.00
Total on Privately Owned - Non-Agricultural Lands.....							\$ 54,687.00	\$ 7,338.00	\$ 161,777.00	\$ 223,802.00
TOTAL ASSESSMENT			16.21	6.56			\$ 92,990.00	\$ 10,137.00	\$ 163,373.00	\$ 266,500.00

1 Hectare = 2.471 Acres
Project No.REI2017D020
August 21st, 2023

SPECIFICATIONS
SHUTTLEWORTH DRAIN - RECONSIDERED
Repair, Improvement and New and Replacement Bridges and Enclosures
E09SH(88)
(Geographic Township of Sandwich South)
TOWN OF TECUMSEH

I. GENERAL SCOPE OF WORK

The Shuttleworth Drain comprises of an open drain generally located along the north side of North Talbot Road extending from its outlet in the Washbrook Drain, proceeding easterly past the parcel 540-00100 at Municipal Number (M.N.) 5790 to the 9th Concession Drain along the west side of the 9th Concession Road, in the geographic township of Sandwich South, Town of Tecumseh. The work under this project generally comprises of repairs and improvements to the open drain from the Washbrook Drain outlet to approximately the midpoint of the parcel 540-00301 at M.N. 5648 and cleaning of the enclosure at the east end. This includes bridge and enclosure repairs, removals and replacements, and new bridges as needed. The excess soil to be loaded up and hauled away for disposal shall be carried out in accordance with the requirements set out in the WSP report included in **Appendix "REI-F"**.

The general layout of the replacement and new access bridges, enclosures and other ancillary work shall be provided as shown and detailed in the accompanying drawings attached within **Appendix "REI-E"**. Benchmarks have been set near along the drain so that the same can be utilized for the setting of the new bridges culvert grades. The **Benchmarks** are as follows:

1. "top nut of fire hydrant located approximately 17.5 metres East of the East end of proposed bridge fronting Municipal Number (M.N.) 5074 on the North side of North Talbot Road", with the same being **Elevation 188.722 metres**
2. "top nut of hydrant on North side of North Talbot Road directly in front of Municipal Number (M.N.) 5410", with the same being **Elevation 188.632 metres**
3. "top nut of hydrant on North side of North Talbot Road at the east end of the bridge enclosure fronting Municipal Number (M.N.) 5480", with the same being **Elevation 188.673 metres**

All work shall be carried out in accordance with these specifications, the plans forming part of this drainage project, as well as the Standard Details included in **Appendix "REI-C"**. The bridge and enclosure replacements shall be of the size, type, depth, etcetera, as is shown in the accompanying drawings, as determined from the Benchmarks, and as may be further laid out at the site at the time of construction. All work carried out under this project shall be completed to the full satisfaction of the Town Drainage Superintendent and the Consulting Engineer.

II. E.R.C.A. AND D.F.O. CONSIDERATIONS

All of the work shall be carried out in accordance with any permits or authorizations issued by the Essex Region Conservation Authority (E.R.C.A.) or the Department of Fisheries and Oceans (D.F.O.), copies of which will be provided, if available. The standard mitigation response received from E.R.C.A. shall be followed and a copy of same is included within **Appendix "REI-A"**. The Contractor shall ensure that sediment and erosion control provisions, set out further in these specifications and in **Appendix "REI-A"**, are followed. Work shall be scheduled so that it can be completed in the dry and when there is no risk of a rain event that might exceed the capacity of the water control system that the Contractor employs. Any damming of the drain will be done on the upstream side in accordance with the provisions set out in **Appendix "REI-A"**. The Contractor will be required to carry out a fish salvage operation if there is water in the drain when the work is being done. Details for the fish salvage are set out in **Appendix "REI-A"** and the Contractor shall include any expected costs in the item prices of the tender.

The Contractor is to review **Appendix "REI-A"** in detail and is required to comply in all regards with the contents of said E.R.C.A. and D.F.O. measures, and follow the special requirements therein included during construction.

The Contractor will be required to implement stringent erosion and sedimentation controls during the course of the work to help minimize the amount of silt and sediment being carried downstream into the outlet drainage system. It is intended that work on this project be carried out during relatively dry weather to ensure proper site and drain conditions and to avoid conflicts with sediment being deposited into the outlet drainage system. All disturbed areas shall be restored as quickly as possible with grass seeding and mulching installed to ensure a protective cover and to minimize any erosion from the work sites subsequent to construction. The Contractor may be required to provide temporary silt fencing and straw bales as outlined further in these specifications.

III. M.N.R.F. & M.E.C.P. ENDANGERED SPECIES ACT CONSIDERATIONS

The Contractor is to note that the Ministry of Environment, Conservation and Parks (M.E.C.P.) screening process by way of a Species at Risk (S.A.R.) review of the M.E.C.P. "Endangered Species Act, 2007" (E.S.A.) will be completed as a self-assessment by the Town pursuant to Section 23.9 of the E.S.A. prior to construction. This Section allows the Town to conduct eligible works of repair, maintenance and improvement to existing municipal drains under the Drainage Act, and exemptions from Sections 9 and 10 of the E.S.A., provided that the requirements are followed in accordance with Ontario Regulation 242/08. The results of the review will be provided to the Contractor and copies of the mitigation measures, habitat protection and identification sheets will be included within **Appendix "REI-B"**.

Providing mitigation requirements are implemented, it was concluded that present wildlife Species at Risk will be protected from negative impacts and the works will not contravene Section 9 (species protection) or Section 10 (habitat protection) of the Endangered Species Act, 2007.

The Contractor is to review **Appendix "REI-B"** in detail and is required to comply in all regards with the contents of said M.N.R.F. & M.E.C.P. measures, and follow the special requirements therein included during construction. Throughout the course of construction the Contractor will be responsible to ensure that all necessary provisions are undertaken to protect all species at risk and their habitats. If a threatened or sensitive species is encountered, the Contractor shall notify the Town and M.N.R.F. - M.E.C.P. and provide all the equipment and materials stipulated by the mitigation requirements for handling the species and cooperate fully with the Town and M.N.R.F. - M.E.C.P. staff in the handling of the species.

IV. ACCESS TO WORK

The Contractor is advised that the majority of the work to be carried out on this project extends along the north side of North Talbot Road. The Contractor shall have access for the full width of the roadway abutting the proposed drainage works. The Contractor may utilize the right-of-way as necessary, to permit the completion of all of the work required to be carried out for this project. The Contractor shall also have access into the driveways as necessary to carry out the removal of the existing access bridges and to construct the new replacement access bridges, as set out on the plans and in these specifications, along with a sufficient area in the vicinity of the bridges to carry out the required construction of the removal and new structure installation and ancillary work.

The Contractor shall ensure that the traveling public is protected at all times while utilizing the roadway for its access. The Contractor shall provide traffic control, including flag persons when required. Should the Contractor have to close North Talbot Road for the proposed works, it shall obtain the permission of the Town Drainage Superintendent or Consulting Engineer and arrange to provide the necessary notification of detours around the site. The Contractor shall also ensure that all emergency services, school bus companies, etcetera are contacted about the disruption to access at least 48 hours in advance of same. All detour routes shall be established in consultation with the Tecumseh Works Department.

Throughout the course of the work it is imperative that the Contractor protect as much landscaping and vegetation as possible when accessing along the drain. This will be of particular concern along the lawn areas of residential properties. Due to the extent of the work and the area for carrying out the work, the Contractor will be required to carry out all of the necessary steps to direct traffic and provide temporary diversion of traffic around work sites, including provision of all lights, signs, flag persons, and barricades required to protect the safety of the traveling public. Any accesses or areas used in carrying out the works are to be fully restored to their original conditions by the Contractor at its cost, including topsoil placement and lawn restoration as directed by the Town Drainage Superintendent and the Consulting Engineer. Restoration shall include but not be limited to all necessary levelling, grading, shaping, topsoil, seeding, mulching, and granular placement required to make good any damage caused.

V. REMOVAL OF BRUSH, TREES AND RUBBISH

Where there is any brush, trees or rubbish along the course of the drainage works, including the full width of the work access, all such brush, trees or rubbish shall be close cut and grubbed out, and the whole shall be chipped up for recycling, burned or otherwise satisfactorily disposed of by the Contractor. The brush and trees removed along the course of the work are to be put into piles by the Contractor in locations where they can be safely chipped and disposed of, or burned by it, or hauled away and disposed of by the Contractor to a site to be obtained by it at its expense. Prior to and during the course of any burning operations, the Contractor shall comply with the guidelines prepared by the Air Quality Branch of the Ontario Ministry of the Environment, and shall ensure that the Environmental Protection Act is not violated. The Contractor will be required to notify the local fire authorities to obtain any permits and cooperate with them in the carrying out of any work. Burning by-law information is included in **Appendix "REI-D"** for reference by the Contractor. The removal of brush and trees shall be carried out in close consultation with the Town Drainage Superintendent or Consulting Engineer to ensure that no decorative trees or shrubs are disturbed by the operations of the Contractor that can be saved. It is the intent of this project to save as many trees and bushes as practical within the roadway allowances and on private lands. Where decorative trees or shrubs are located directly over drainage pipes, the Contractor shall carefully extract same and turn them over to the Owner when requested to do so, and shall cooperate with the Owner in the reinstallation of same if required.

The Contractor shall protect all other trees, bushes, and shrubs located along the length of the drainage works except for those trees that are established, in consultation with the Town Drainage Superintendent, the Consulting Engineer, and the Owners, to be removed as part of the works. The Contractor shall note that protecting and saving the trees may require the Contractor to carry out hand work around the trees, bushes, and shrubs to complete the necessary final site grading and restoration.

Following the completion of the work, the Contractor is to trim up any broken or damaged limbs on trees which are to remain standing, and it shall dispose of said branches along with other brush, thus leaving the trees in a neat and tidy condition.

VI. FENCING

Where it is necessary to take down any fence to proceed with the work, the same shall be done by the Contractor across or along that portion of the work where such fence is located. The Contractor will be required to exercise extreme care in the removal of any fencing so as to cause a minimum of damage to same. The Contractor will be required to reinstall any fence that is taken down in order to proceed with the work, and the fence shall be reinstated in a neat and workmanlike manner. The Contractor will not be required to procure any new materials for rebuilding the fence provided that it has used reasonable care in the removal and replacement of same. When any fence is removed by the Contractor, and the Owner thereof deems it

advisable and procures new material for replacing the fence so removed, the Contractor shall replace the fence using the new materials and the materials from the present fence shall remain the property of the Owner.

VII. TOPSOIL, SEED AND MULCH

The Contractor shall be required to restore all existing grassed areas and drain side slopes damaged by the structure construction or cutting of the drain cross section, by placing topsoil, and then seed and mulch over said areas including any specific areas noted on the bridge details. The Contractor shall be required to provide all the material and to cover the above mentioned surfaces with approximately 50mm of good, clean, dry topsoil on slopes and 100mm of good, clean, dry topsoil on horizontal surfaces, fine graded and spread in place ready for seeding and mulching. The placing and grading of any topsoil shall be carefully and meticulously carried out in accordance with Ontario Provincial Standard Specifications, Form 802 dated November 2010, or as subsequently amended, or as amended by these specifications and be readied for the seeding and mulching process. The seeding and mulching of all of the above mentioned areas shall comply in all regards to Ontario Provincial Standard Specifications, Form 803 dated November 2010 and Form 804, dated November 2013, or as subsequently amended, or as amended by these specifications. The seeding mixture shall be the Standard Roadside Mix (Canada No. 1 Lawn Grass Seed Mixture) as set out in O.P.S.S. 804. All cleanup and restoration work shall be performed to the full satisfaction of the Town Drainage Superintendent or Engineer.

When all of the work for this installation has been completed, the Contractor shall ensure that positive drainage is provided to all areas, and shall ensure that the site is left in a neat and workmanlike manner, all to the full satisfaction of the Town Drainage Superintendent or Engineer.

VIII. DETAILS OF BRIDGE AND ENCLOSURE WORK

The Contractor shall provide all material, labour, and equipment to repair and improve the existing access bridges and enclosures in the Shuttleworth Drain requiring work, along with endwall repairs, catch basins and other improvements as noted.

The new access bridge and enclosure installations shall comprise of smooth wall H.D.P.E. (high density polyethylene) pipe with a minimum strength of 320 kPa. All piping sections shall be connected by the use of wrap couplers installed around the complete circumference of the pipe in accordance with the manufacturer's recommendation. Each coupler shall be wrapped in filter cloth material around the complete circumference to ensure that there will be no soil migration through the joints and into the pipe through said connections. All plastic pipe ends shall be anchored down by the Contractor to prevent flotation and deflection from the design grade.

The culvert pipe and enclosure replacements and new pipe and enclosure installations on this project shall be set to the grades as shown on the plans or as otherwise established herein and

the Town Drainage Superintendent or the Consulting Engineer may make minor changes to the bridge alignment as they deem necessary to suit the site conditions. All work shall be carried out in general accordance with the items in the **“STANDARD SPECIFICATIONS FOR ACCESS BRIDGE CONSTRUCTION”** attached to this specification and labelled **Appendix “REI-C”**.

The Contractor shall also note that the placement of any new access bridge culvert or enclosure is to be performed totally in the dry, and it shall be prepared to take whatever steps are necessary to ensure same, all to the full satisfaction of the Town Drainage Superintendent or Engineer. As part of the work, the Contractor will be required to clean out the drain along the full length of the bridge and enclosure pipe and for a distance of 3.0 metres (10 ft.) both upstream and downstream of said pipe. The design parameters of the Shuttleworth Drain at the location of each new and replacement access bridge and enclosure installation consists of a 0.91m (3.0 ft.) bottom width, the grade shown on the profile, and 2.0 horizontal to 1.0 vertical sideslopes. The Contractor shall be required to cut any brush and strip the existing drain sideslopes of any vegetation as part of the grubbing operation. The Contractor shall also dispose of all excavated and deleterious materials, as well as any grubbed out materials, to a site to be obtained by it at its own expense. The Contractor shall note that the survey indicates that the existing drain bottom is slightly above the design grade. The Contractor shall be required to provide any and all labour, material, and equipment to set the pipes to the required design grades. The Contractor shall also be required to supply, if necessary for a solid base, a minimum thickness of 100mm (4”) of 20mm (3/4”) clear stone bedding underneath the culvert or enclosure pipe, extending from the bottom of the excavation to the culvert or enclosure invert grade, all to the full satisfaction of the Town Drainage Superintendent or Engineer.

The installation of the complete length of each new replacement access bridge culvert or enclosure, including all appurtenances, shall be completely inspected by the Town Drainage Superintendent or Engineer prior to backfilling any portions of same. Under no circumstance shall the Contractor backfill same until the Town Drainage Superintendent or Engineer inspects and approves said pipe installation. The Contractor shall provide a minimum notice of 2 working days to the Town Drainage Superintendent or Engineer prior to the commencement of this work. The installation of each new access bridge or enclosure is to be performed during the normal working hours from Monday to Friday of the Town Drainage Superintendent or Engineer.

Once the H.D.P.E. pipe has been satisfactorily set in place at the site, the Contractor shall completely backfill same at driveway entrances with granular material M.T.O. Type “B” O.P.S.S. (Ontario Provincial Standard Specification) Form 1010, with the exception of the top 305mm (12”) of the backfill material for the full top width of the drain and the access bridge, which shall be granular material M.T.O. Type “A” O.P.S.S. Form 1010. Enclosure pipes at lawn areas shall be backfilled with select native material compacted to a minimum of 95% of S.P.D. and include provision of swale grading to conduct flows to pipe ends or into catch basins. The end slopes of the backfill material over the H.D.P.E. plastic pipe from the invert of said pipe to the top of driveway or swale elevation shall be quarried limestone on filter cloth erosion protection. The end walls shall be extended around onto the drain banks in line with the end of the bridge culvert pipe as shown on the plans included in **Appendix “REI-E”**. The pipe ends shall be securely

anchored against flotation. Precast concrete block endwalls shall be provided where shown on the plans.

The Contractor shall also perform the necessary excavation to extend the driveway beyond the north top of bank for the Shuttleworth Drain as illustrated on the plans. This driveway approach from the existing edge of gravel shoulder to the north top of bank shall consist of a minimum of 305mm (12") of granular material M.T.O. Type "A" satisfactorily compacted in place. The gravel apron shall extend for the full width of the access culvert length and include a 5.0m radius daylighting section at the roadside to the edge of the gravel shoulder, as shown on the plans. The gravel backfill shall also extend across the pipe to approximately 1.0m past the north top of bank limit as shown on the plans.

Once the H.D.P.E. plastic pipe culvert has been set in place at the required location for the access driveway, the Contractor shall completely backfill same with granular material, and install the quarried limestone on filter cloth protection or precast concrete block headwalls on both ends of the bridge. The installation of the endwalls, as well as the backfilling of the pipe where applicable, shall be provided in compliance with Items 1), 2), 3), and 4) of the "**Standard Specifications for Access Bridge Construction**" attached within **Appendix "REI-C"** and in total compliance and in all respects with the General Conditions included in Item 4) of said Appendix. The Contractor, in all cases, shall comply with these specifications and upon completion of the sloped quarried limestone end protection or precast concrete block headwall installation shall restore the adjacent areas to their original conditions. The Contractor shall supply quarried limestone on filter cloth rock protection on each end of the pipe. All rock protection shall be 305mm (12") thick, installed on non-woven filter cloth, and shall be installed in accordance with Item 2) of the "**Standard Specifications for Access Bridge Construction**". The synthetic filter fabric to be used shall be non-woven geotextile GMN160 conforming to O.P.S.S. 1860 Class I, as available from Armtec Construction Products through Underground Specialties - Wolseley in Windsor, Ontario, or equal. The quarried limestone to be used shall be graded in size from a minimum of 100mm to a maximum of 250mm, and is available from Walker Industries Amherst Quarry, in Amherstburg, Ontario, or equal.

The H.D.P.E. plastic pipe for this installation shall be provided with a minimum depth of cover measured from the top of the H.D.P.E. plastic pipe to the top of the granular backfill or native backfill of approximately 305mm (1 ft.) for the new replacement bridge and if the culvert is placed at its proper elevations, this should be easily achieved. If the Contractor finds that the specified cover is not being met, they shall notify the Drainage Superintendent and the Engineer immediately so that steps can be taken to rectify the condition prior to the placement of any backfill. The cover requirement is **critical** and must be attained. In order for this new access bridge culvert and enclosure to properly fit the channel parameters, all of the design grade elevations provided must be strictly adhered to.

The Contractor shall also be required to provide all labour, equipment and material to provide granular fill to all gore areas at the laneway as noted on the plans. The Contractor shall provide

a 5.0 metre radius on the roadside approach of the drain as seen on the plans and protect any existing landscape features during the course of the work.

As part of the work provided for the construction of the access bridge, the Contractor shall be required to protect or extend any existing lateral tile ends and swales which conflict with the bridge installation. All existing lateral tile drains and swales, where required, shall be diverted and extended to the ends of the new access bridge culvert and shall be extended and installed in accordance with the "Standard Lateral Tile Detail" as shown in **Appendix "REI-C"**, unless otherwise noted. Connections shall be made using manufacturer's couplers wherever possible. All other connections shall be completely sealed with concrete grout around the full exterior perimeter of each joint.

The Contractor is to note that the granular driveway approaches extending from the existing edge of gravel shoulder to the north top of bank of the drain shall consist of granular material M.T.O. Type "A" O.P.S.S. Form 1010 and is to be provided to a minimum depth of 305mm (12"), and be satisfactorily compacted in place. The Contractor is to also note that all granular material being placed as backfill for this bridge installation shall be compacted in place to a minimum Standard Proctor Density of 100%, and that all native fill material to be used for the construction shall be compacted in place to a minimum Standard Proctor Density of 95%.

All of the granular backfill, native fill, and the compaction levels for same shall be provided to the full satisfaction of the Town Drainage Superintendent or the Engineer. The Contractor shall also note that any sediment being removed from the drain bottom as previously specified herein, shall not be utilized for the construction of the driveway, and shall be disposed of by the Contractor to a site to be obtained by it at its own expense.

The Contractor shall be required to restore any and all drain sideslopes damaged by the access bridge or enclosure installation and removal of vegetation, utilizing the available scavenged topsoil, and shall seed and mulch over all of said areas.

The placing and grading of any topsoil shall be carefully and meticulously carried out in accordance with Ontario Provincial Standard Specifications, Form 802 dated November 2010, or as subsequently amended, or as amended by these specifications and be readied for the seeding and mulching process. The seeding and mulching of all of the above mentioned areas shall comply in all regards to Ontario Provincial Standard Specifications, Form 803 dated November 2010 and Form 804, dated November 2013, or as subsequently amended, or as amended by these specifications. The seeding mixture shall be the Standard Roadside Mix (Canada No. 1 Lawn Grass Seed Mixture) as set out in O.P.S.S. 804. All cleanup and restoration work shall be performed to the full satisfaction of the Town Drainage Superintendent or Engineer.

When all of the work for this installation has been completed, the Contractor shall ensure that positive drainage is provided to all areas, and shall ensure that the site is left in a neat and workmanlike manner, all to the full satisfaction of the Town Drainage Superintendent or Engineer.

IX. DETAILS OF OPEN DRAIN WORK

The open drain shall be excavated to the lines, levels, grades and cross-sections as shown on the accompanying drawings, or as may be further established by the Town Drainage Superintendent or the Engineer at the time of the work. The drain shall be carefully excavated so as not to disturb the existing banks, rock protection and vegetation, except for those portions of the drain where widening or restoration of a stable drain bank configuration is required. The bottom width of the drain and the sideslopes of the excavation shall conform to the dimensions given on the drawings.

The drain shall be of the size, type, depth, etcetera as shown on the accompanying drawings. When completed, the drain shall have a uniform and even bottom and in no case shall such bottom project above the grade line, as shown on the accompanying drawings, and as determined from the Benchmarks. The finished side slopes of the drain shall be 2.0 metres horizontal to 1.0 metre vertical.

The excavated material to be cast onto the adjoining lands shall be well and evenly spread over a sufficient area so that no portion of the excavated earth is more than 100mm in depth. The material shall be kept at least 1.2 metres clear from the finished edge of the drain, care being taken not to fill up any existing tiles, ditches, furrows or drains with the excavated material. The excavated material to be spread upon the lands shall be free from rocks, cobbles, boulders, stumps, rubble, rubbish or other similar material and these materials, if encountered, shall be hauled away by the Contractor and disposed of at a site to be obtained by it at its expense.

Where the drain crosses any lawn, garden, orchard, roadway or driveway, etcetera, the excavated material for the full width of the above-mentioned areas shall be hauled away by the Contractor and disposed of to a site to be obtained by the Contractor at its expense. All work at the disposal site shall be established between the Contractor and the site owner. The Contractor shall be responsible for any permits required and shall provide copies of same to the Town and Consulting Engineer when requested. The handling of these excess soils shall be conducted in accordance with the requirements set out in **Appendix "REI-F"**.

Where there is any brush or rubbish in the course of the drain, including both side slopes of the drain, all such brush or rubbish shall be close cut and grubbed out. Where there is any brush or rubbish where the earth is to be spread, or on that strip of land between where the earth is to be spread and the edge of the drain, all such brush or rubbish shall be close cut and grubbed out. The whole is to be burned, chipped, or otherwise satisfactorily disposed of by the Contractor.

X. REMOVALS

Where existing access bridges and enclosures are to be completely removed and replaced, the Contractor shall be required to excavate and completely extract the existing structure or culvert pipe and the existing endwalls in their entirety, as well as any other deleterious materials that may be encountered in removing same, excluding poured concrete headwalls that are to be reused. The Contractor shall neatly saw cut any concrete or asphalt surfaces over the pipes for a sufficient width to allow for the safe removal of same or go to the nearest expansion joint panel of the concrete driveways. The Contractor shall also be required to completely dispose of all removed materials to a site to be obtained by it at its own expense in accordance with the excess soils handling requirements in **Appendix "REI-F"**. The Contractor shall note that when headwalls are shown to be left in place, the Contractor shall protect same and carry out its work for the pipe replacement as noted above and dispose of any debris resulting from the work.

All unsuitable and deleterious materials from the excavation and removal of the existing bridge and enclosure culverts and drain cleaning shall be hauled away and disposed of by the Contractor to a site to be obtained by it at its expense. Likewise, any material excavated to allow for the granular approaches to the bridge, driveway transitions, or installation of new headwalls shall also be hauled away and disposed of by the Contractor with all materials handled in accordance with the excess soil requirements in **Appendix "REI-F"**.

XI. CONCRETE FILLED JUTE BAG, PRECAST CONCRETE BLOCK OR SLOPED END PROTECTION

Unless otherwise shown or noted, the Contractor is to provide new concrete filled jute bag headwalls, precast concrete block, or sloped quarried limestone on non-woven filter cloth end protection for the access bridges and enclosures being replaced or constructed on this drain.

The concrete filled jute bags are to be provided and laid out as is shown and detailed in the drawings provided by the Town and as noted in the Standard Specifications in **Appendix "REI-C"**. In all cases, the concrete filled jute bag headwalls shall be topped with a minimum 100mm (4") thick continuous concrete cap comprising 30MPa concrete with 6% ±1% air entrainment for the entire length of the headwalls. The headwalls shall be installed on an inward batter to be not less than 1 horizontal to 5 vertical, and under no circumstances shall this batter, which is measured from the top of the headwall to the projection of the end of the pipe, be less than 305mm (12"). From the midpoint of the pipe height down to the concrete footing, the wall shall be a double concrete filled jute bag installation. On the road side the walls shall be deflected as shown to provide daylighting and a better approach across the new bridge.

The installation of the concrete filled jute bag headwalls, unless otherwise specified, shall be provided in total compliance with the Items 1, 3, and 4 included in the **"STANDARD SPECIFICATIONS FOR ACCESS BRIDGE CONSTRUCTION"**. These are attached to the back of these specifications and labelled **Appendix "REI-C"**. The Contractor shall comply in all respects with

the General Conditions included in Item 4 and the **“Typical Concrete Filled Jute Bag Headwall End Protection”** detail also shown therein.

The Contractor shall install interlocking precast concrete blocks with filter cloth backing for walls on both ends of the bridges requiring same. The blocks shall be minimum 600X600X1200mm in size as available from Underground Specialties - Wolseley, Windsor, Ontario, or equal, and installed as set out in **Appendix "REI-C"**. Vertical joints shall be staggered by use of half blocks where needed and wingwall deflections when required shall employ 45-degree angled blocks. Voids between the blocks and the pipe shall be grouted with 30MPa concrete having 6% ±1% air entrainment and extend for the full thickness of the wall and have a smooth uniform finish on the face that blends with the precast blocks. The installation of the endwalls, as well as the backfilling of the pipe where applicable, shall be provided in compliance with Items 1), 3), and 4) of the "Standard Specifications for Access Bridge Construction" attached within **Appendix "REI-C"** and in total compliance and in all respects with the General Conditions included in said Appendix. The Contractor shall submit shop drawings for approval of the wall installation that includes details for a minimum 300mm thick concrete footing that extends from the pipe invert downward. The footing shall extend into the drain banks each side for the required embedment of the blocks and be constructed to ensure that the completed wall will be completely vertical or tipped slightly back towards the driveway. Where the block walls extend more than 1.8 metres in height, the supplier shall provide the Contractor with uni-axial geogrid (SG350 or equivalent) reinforcement for installation to tie the wall back into the granular backfill. The Contractor, in all cases, shall comply with these specifications and upon completion of the stacked precast concrete end protection installation shall restore the adjacent areas to their original conditions. The Contractor shall supply quarried limestone on filter cloth rock protection adjacent to the headwalls at each corner of the bridge. All rock protection shall be 1.0 metres wide and 305mm (12") thick, installed on non-woven filter cloth, and shall be installed in accordance with Item 2) of the "Standard Specifications for Access Bridge Construction". The synthetic filter mat to be used shall be non-woven geotextile GMN160 conforming to O.P.S.S. 1860 Class I, as available from Armtec Construction Products through Underground Specialties - Wolseley in Windsor, Ontario or equal. The quarried limestone to be used shall be graded in size from a minimum of 100mm to a maximum of 250mm, and is available from Walker Industries Amherst Quarries, in Amherstburg, Ontario, or equal.

Where sloped end protection is specified, the top 305mm (12") of backfill material over the ends of the access pipe, from the invert of said pipe to the top of the driveway elevation of the access bridge or enclosure, shall be quarried limestone. The quarried limestone shall be provided as shown and detailed on the plans or as indicated in the Standard Specifications in **Appendix "REI-C"** and shall be graded in size from a minimum of 100mm (4") to a maximum of 250mm (10"). The quarried limestone to be placed on the sloped ends of an access bridge or enclosure shall be underlain with a synthetic **non-woven** geotextile filter fabric. The sloped quarried limestone protection is to be rounded as shown on the plan details and shall also extend along the drain side slopes to a point directly in line with the ends of the culvert pipe or enclosure. The road side approach to the entrance shall be provided with a minimum 5.0m radius at each end of the

driveway entrance. All work shall be completed to the full satisfaction of the Town Drainage Superintendent or the Consulting Engineer.

The installation of the sloped quarried limestone end protection, unless otherwise specified herein, shall be provided in total compliance with Item 2), 3), and 4) of the **“STANDARD SPECIFICATIONS FOR ACCESS BRIDGE CONSTRUCTION”**. These are attached to the back of these specifications and labelled **Appendix “REI-C”**. The Contractor shall comply in all respects with the General Conditions included in Item 4 and the **“Typical Quarried Limestone End Protection Detail”** also in **Appendix “REI-C”**.

The quarried limestone erosion protection shall be embedded into the sideslopes of the drain a minimum thickness of 305mm and shall be underlain in all cases with non-woven synthetic filter mat. The filter mat shall not only be laid along the flat portion of the erosion protection, but also contoured to the exterior limits of the quarried limestone and the unprotected slope. The width of the erosion protection shall be as established in the accompanying drawings or as otherwise directed by the Town Drainage Superintendent or the Consulting Engineer during construction. In placing the erosion protection, the Contractor shall carefully tamp the quarried limestone pieces into place with the use of the excavator bucket so that the erosion protection when completed will be consistent, uniform and tightly laid. In no instance shall the quarried limestone protrude beyond the exterior contour of the unprotected drain sideslopes along either side of said protection. The synthetic filter mat fabric to be used shall be non-woven geotextile GMN160 conforming to O.P.S.S. 1860 Class I, as available from Armtec Construction Products, or equal. The quarried limestone to be used shall be graded in size from a minimum of 100mm to a maximum of 250mm, and is available from Walker Aggregates Amherst Quarries, in Amherstburg, Ontario, or equal.

XII. BENCHMARKS

Also, for use by the Contractor, we have established Benchmarks along the course of the work and especially at the locations where existing access bridges are being replaced or new bridges are being constructed.

For each of the bridge and enclosure replacements and new bridges and enclosures, the plans include details illustrating the work to be carried out. For each bridge and enclosure detail a Benchmark has been indicated and the Elevation has been shown and may be utilized by the Contractor in carrying out its work. The Contractor shall note that in each case a specific design elevation grade has been provided for the invert at each end of the pipe in the table accompanying each detail. The table also sets out the pipe size, materials, and other requirements relative to the installation of the culvert or enclosure structure. In all cases, the Contractor is to utilize the specified drain grade to set any new pipe installation. The Contractor shall ensure that it takes note of the direction of flow and sets all pipes to assure that all grades flow from high to low points to match the direction of flow within the drain. The Contractor's attention is drawn to the fact that the pipe invert grades established herein provide for the pipes

to be set at least 10% of their diameter or pipe rise below the existing drain bottom or the design grade of the drain, whichever is lower.

XIII. ANCILLARY WORK

During the course of any work to the bridges and enclosures along the length of the project, the Contractor will be required to protect or extend any existing tile ends or swales and connect them to the drainage works to maintain the drainage from the adjacent lands. All existing tiles shall be extended utilizing solid Big 'O' "standard tile ends" or equal plastic pipe of the same diameter as the existing tile and shall be installed in accordance with the "**Standard Lateral Tile Detail**" included in the plans, unless otherwise noted. Connections shall be made using a manufacturer's coupling where possible. Wherever possible, tiles shall be extended to outlet beyond the end of any access culverts. When required, openings into new pipes shall be neatly bored, saw cut or burned with a torch to the satisfaction of the Town Drainage Superintendent or the Consulting Engineer. All cuts to steel pipes shall be touched up with a thick coat of zinc rich paint (Galvicon or equal) in accordance with the manufacturer's recommendations. For other connections, the Contractor shall utilize a grouted connection. Grouted mortar joints shall be composed of three (3) parts of clean, sharp sand to one (1) part of Portland cement with just sufficient water added to provide a stiff plastic mix, and the mortar connection shall be performed to the full satisfaction of the Town Drainage Superintendent or the Consulting Engineer. The mortar joint shall be of a sufficient mass around the full circumference of the joint on the exterior side to ensure a tight, solid seal. The Contractor is to note that any intercepted pipes along the length of the existing culverts and enclosures are to be extended and connected to the open drain unless otherwise noted in the accompanying drawings.

Where the bridge or enclosure installation interferes with the discharge of an existing swale, the Contractor shall re-grade the existing swales to allow for the surface flows to freely enter the drain. Any disturbed grass areas shall be fully restored with topsoil, seed and mulch.

All granular backfill for the bridge and enclosure installations shall be satisfactorily compacted in place to a minimum Standard Proctor Density of 98% by means of mechanical compaction equipment. All other good, clean, native fill material or topsoil to be utilized, where applicable, shall be compacted in place to a minimum Standard Proctor Density of 95%. All of the backfill material, equipment used, and method of compacting the backfill material shall be provided and performed to the full satisfaction of the Town Drainage Superintendent or Consulting Engineer.

Where the Contractor removes concrete or asphalt hard surfaces over the pipes, the Contractor shall restore the hard surfaces as previously outlined. The Contractor will be responsible to restore any damage caused to these driveways at its cost. All damaged hard surface driveway areas shall be neatly saw cut and the damaged materials removed and disposed of by the Contractor prior to carrying out any restoration work.

Any new corrugated aluminized steel type II or H.D.P.E. pipes for these installations are to be provided with a minimum depth of cover measured from the top of the pipe of 305mm (12") for a round pipe and 500mm for a pipe arch. If the bridge culvert pipes are placed at their proper elevations, same should be achieved. If the Contractor finds that the minimum cover is not being met, they shall notify the Town Drainage Superintendent and the Consulting Engineer immediately so that steps can be taken to rectify the condition prior to the placement of any backfill. The minimum cover requirement is **critical** and must be attained. In order for these new access bridge culverts to properly fit the channel parameters, **all of the design grade elevations must be strictly adhered to.**

As a check, all of the above access bridge and enclosure culvert design grade elevations should be confirmed before commencing to the next stage of the access bridge or enclosure installation. The Contractor is also to check that the pipe invert grades are correct by referencing the Benchmark.

Although it is anticipated that the culvert or enclosure installation at each site shall be undertaken in the dry, the Contractor shall supply and install a temporary straw bale or silt curtain check dam in the drain bottom immediately downstream of each culvert or enclosure site during the time of construction. The straw bale or silt curtain check dam shall be to the satisfaction of the Town Drainage Superintendent or Consulting Engineer and must be removed upon completion of the construction. The check dam materials may be reused at each site subject to their condition. All costs associated with the supply and installation of this straw bale or silt curtain check dam shall be included in the cost bid for the bridge or enclosure installations or replacements.

XIV. GENERAL CONDITIONS

- a) The Town Drainage Superintendent or Consulting Engineer shall have authority to carry out minor changes to the work where such changes do not lessen the efficiency of the work.
- b) The Contractor shall satisfy itself as to the exact location, nature and extent of any existing structure, utility or other object which it may encounter during the course of the work. The Contractor shall indemnify and save harmless the Town of Tecumseh and the Consulting Engineer and their representatives for any damages which it may cause or sustain during the progress of the work. It shall not hold the Town of Tecumseh or the Consulting Engineer liable for any legal action arising out of any claims brought about by such damage caused by it.
- c) The Contractor shall provide a sufficient number of layout stakes and grade points so that the Drainage Superintendent and Consulting Engineer can review same and check that the work will generally conform to the design and project intent.
- d) The Contractor will be responsible for any damage caused by it to any portion of the Town road system, especially to the travelled portion. When excavation work is being carried out

and the excavation equipment is placed on the travelled portion of the road, the travelled portion shall be protected by having the excavation equipment placed on satisfactory timber planks or timber pads. If any part of the travelled portion of the road is damaged by the Contractor, the Town shall have the right to have the necessary repair work done by its' employees and the cost of all labour and materials used to carry out the repair work shall be deducted from the Contractor's contract and credited to the Town. The Contractor, upon completing the works, shall clean all debris and junk, etc., from the roadside of the drain, and leave the site in a neat and workmanlike manner. The Contractor shall be responsible for keeping all public roadways utilized for hauling materials free and clear of mud and debris.

- e) The Contractor shall provide all necessary lights, signs, and barricades to protect the public. All work shall be carried out in accordance with the requirements of the Occupational Health and Safety Act, and latest amendments thereto. If traffic control is required on this project, signing is to comply with the M.T.O. Manual of Uniform Traffic Control Devices (M.U.T.C.D.) for Roadway Work Operations and Ontario Traffic Manual Book 7.
- f) During the course of the work the Contractor shall be required to connect existing drainage pipes to the Municipal Drain. In the event that polluted flows are discovered, the Contractor shall delay the connection of the pipe and leave the end exposed and alert the Town, the Drainage Superintendent and the Consulting Engineer so that steps can be taken by the Town to address the concern with the owner and the appropriate authorities. Where necessary the Contractor shall cooperate with the Town in providing temporary measures to divert the drain or safely barricade same. Should the connection be found acceptable by the authorities, the Contractor shall complete the connection of the drain as provided for in the specifications, at no extra cost to the project.
- g) Following the completion of the work, the Contractor is to trim up any broken or damaged limbs on trees which are to remain standing, and it shall dispose of said branches along with other brush, thus leaving the trees in a neat and tidy condition.
- h) The whole of the work shall be satisfactorily cleaned up, and during the course of the construction, no work shall be left in any untidy or incomplete state before subsequent portions are undertaken.
- i) During the course of the project the Contractor shall deal with any excess soil management from the project in accordance with Ontario Reg 406/19 pursuant to the Environmental Protection Act, R.S.O. 1990, c. E.19 and any subsequent amendments to same, and the provisions included in **Appendix "REI-F"**.
- j) All driveways, laneways and access bridges, or any other means of access on to the job site shall be fully restored to their former condition at the Contractor's expense. Before authorizing Final Payment, the Town Drainage Superintendent and the Consulting Engineer shall inspect the work in order to be sure that the proper restoration has been performed.

In the event that the Contractor fails to satisfactorily clean up any portion of these accesses, the Consulting Engineer shall order such cleanup to be carried out by others and the cost of same be deducted from any monies owing to the Contractor.

- k) The Contractor will be required to submit to the Town, a Certificate of Good Standing from the Workplace Safety and Insurance Board prior to the commencement of the work and the Contractor will be required to submit to the Town, a Certificate of Clearance for the project from the Workplace Safety and Insurance Board before Final Payment is made to the Contractor.
- l) The Contractor shall furnish a Performance and Maintenance Bond along with a separate Labour and Material Payment Bond within ten (10) days after notification of the execution of the Agreement by the Town. One copy of said bonds shall be bound into each of the executed sets of the Contract. Each Performance and Maintenance Bond and Labour and Material Payment Bond shall be in the amount of 100% of the total Tender Price. All Bonds shall be executed under corporate seal by the Contractor and a surety company, authorized by law to carry out business in the Province of Ontario. The Bonds shall be acceptable to the Town in every way and shall guarantee faithful performance of the contract during the period of the contract, including the period of guaranteed maintenance which will be in effect for twelve (12) months after substantial completion of the works.

The Tenderer shall include the cost of bonds in the unit price of the Tender items as no additional payment will be made in this regard.

- m) The Contractor shall be required, as part of this Contract, to provide Comprehensive Liability Insurance coverage for not less than \$5,000,000.00 on this project; and shall name the Town of Tecumseh and its' officials and the Consulting Engineer and their staff as additional insured under the policy. The Contractor must submit a copy of this policy to both the Town Clerk and the Consulting Engineer prior to the commencement of work.
- n) Monthly progress orders for payment shall be furnished the Contractor by the Town Drainage Superintendent. Said orders shall be for not more than 90% of the value of the work done and the materials furnished on the site. The paying of the full 90% does not imply that any portion of the work has been accepted. The remaining 10% will be paid 60 days after the final acceptance and completion of the work and payment shall not be authorized until the Contractor provides the following:
 - i) a Certificate of Clearance for the project from the Workplace Safety and Insurance Board
 - ii) proof of advertising

The Contractor shall satisfy the Consulting Engineer or Town that there are no liens or claims against the work and that all of the requirements as per the Construction Act, 2018 and its' subsequent amendments have been adhered to by the Contractor.

- o) In the event that the Specifications, Information to Tenderers, or the Form of Agreement do not apply to a specific condition or circumstance with respect to this project, the applicable section or sections from the Canadian Construction Documents Committee C.C.D.C.2 shall govern and be used to establish the requirements of the work.
- p) Should extra work be required by the Town Drainage Superintendent or Consulting Engineer and it is done on a time and material basis, the actual cost of the work will be paid to the Contractor with a 15% markup on the total actual cost of labour, equipment and materials needed to complete the extra work.

APPENDIX "REI-A"

STANDARD E.R.C.A. AND D.F.O.
MITIGATION REQUIREMENTS

As part of its work, the Contractor will implement the following measures that will ensure that any potential adverse effects on fish and fish habitat will be mitigated:

1. As per standard requirements, work will not be conducted at times when flows in the drain are elevated due to local rain events, storms, or seasonal floods. Work will be done in the dry.
2. All disturbed soils on the drain banks and within the channel, including spoil, must be stabilized immediately upon completion of work. The restoration of the site must be completed to a like or better condition to what existed prior to the works. The spoil material must be hauled away and disposed of at a suitable site, or spread an appropriate distance from the top of the drain bank to ensure that it is not washed back into the drain.
3. To prevent sediment entry into the drain in the event of an unexpected rainfall, silt barriers and/or traps must be placed in the channel during the works and until the site has been stabilized. All sediment and erosion control measures are to be in accordance with the related Ontario Provincial Standards. It is incumbent on the proponent and Contractors to ensure that sediment and erosion control measures are functioning properly and maintained/upgraded as required.
4. Silt or sand accumulated in the barrier traps must be removed and stabilized on land once the site is stabilized.
5. All activities including maintenance procedures should be controlled to prevent the entry of petroleum products, debris, rubble, concrete, or other deleterious substances into the water. Vehicular refuelling and maintenance should be conducted away from the water.
6. Any drain banks trimmed outside of the July 1st to September 15th timing window will require erosion control blankets to be installed to promote re-vegetation and to protect the slope from erosion in the interim.

Measures to Avoid Causing Harm to Fish and Fish Habitat

If you are conducting a project near water, it is your responsibility to ensure you avoid causing [serious harm to fish](#) in compliance with the *Fisheries Act*. The following advice will help you avoid causing harm and comply with the *Act*.

PLEASE NOTE: This advice applies to all project types and replaces all “Operational Statements” previously produced by DFO for different project types in all regions.

Measures

- Time work in water to respect [timing windows](#) to protect fish, including their eggs, juveniles, spawning adults and/or the organisms upon which they feed.
- Minimize duration of in-water work.
- Conduct instream work during periods of low flow, or at low tide, to further reduce the risk to fish and their habitat or to allow work in water to be isolated from flows.
- Schedule work to avoid wet, windy and rainy periods that may increase erosion and sedimentation.

- Design and plan activities and works in waterbody such that loss or disturbance to aquatic habitat is minimized and sensitive spawning habitats are avoided.
- Design and construct approaches to the waterbody such that they are perpendicular to the watercourse to minimize loss or disturbance to riparian vegetation.
- Avoid building structures on meander bends, braided streams, alluvial fans, active floodplains or any other area that is inherently unstable and may result in erosion and scouring of the stream bed or the built structures.
- Undertake all instream activities in isolation of open or flowing water to maintain the natural flow of water downstream and avoid introducing sediment into the watercourse.

- Plan activities near water such that materials such as paint, primers, blasting abrasives, rust solvents, degreasers, grout, or other chemicals do not enter the watercourse.
- Develop a response plan that is to be implemented immediately in the event of a sediment release or spill of a deleterious substance and keep an emergency spill kit on site.
- Ensure that building material used in a watercourse has been handled and treated in a manner to prevent the release or leaching of substances into the water that may be deleterious to fish.

- Develop and implement an Erosion and Sediment Control Plan for the site that minimizes risk of sedimentation of the waterbody during all phases of the project. Erosion and sediment control measures should be maintained until all disturbed ground has been permanently stabilized, suspended sediment has resettled to the bed of the waterbody or settling basin and runoff water is clear. The plan should, where applicable, include:
 - Installation of effective erosion and sediment control measures before starting work to prevent sediment from entering the water body.
 - Measures for managing water flowing onto the site, as well as water being pumped/diverted from the site such that sediment is filtered out prior to the water entering a waterbody. For example, pumping/diversion of water to a vegetated area, construction of a settling basin or other filtration system.
 - Site isolation measures (e.g., silt boom or silt curtain) for containing suspended sediment where in-water work is required (e.g., dredging, underwater cable installation).
 - Measures for containing and stabilizing waste material (e.g., dredging spoils, construction waste and materials, commercial logging waste, uprooted or cut aquatic plants, accumulated debris) above the high water mark of nearby waterbodies to prevent re-entry.
 - Regular inspection and maintenance of erosion and sediment control measures and structures during the course of construction.
 - Repairs to erosion and sediment control measures and structures if damage occurs.
 - Removal of non-biodegradable erosion and sediment control materials once site is stabilized.
- Clearing of riparian vegetation should be kept to a minimum: use existing trails, roads or cut lines wherever possible to avoid disturbance to the riparian vegetation and prevent soil compaction. When practicable, prune or top the vegetation instead of grubbing/uprooting.
- Minimize the removal of natural woody debris, rocks, sand or other materials from the banks, the shoreline or the bed of the waterbody below the ordinary high water mark. If material is removed from the waterbody, set it aside and return it to the original location once construction activities are completed.
- Immediately stabilize shoreline or banks disturbed by any activity associated with the project to prevent erosion and/or sedimentation, preferably through re-vegetation with native species suitable for the site.
- Restore bed and banks of the waterbody to their original contour and gradient; if the original gradient cannot be restored due to instability, a stable gradient that does not obstruct fish passage should be restored.
- If replacement rock reinforcement/armouring is required to stabilize eroding or exposed areas, then ensure that appropriately-sized, clean rock is used; and that rock is installed at a similar slope to maintain a uniform bank/shoreline and natural stream/shoreline alignment.
- Remove all construction materials from site upon project completion.

- Ensure that all in-water activities, or associated in-water structures, do not interfere with fish passage, constrict the channel width, or reduce flows.
- Retain a qualified environmental professional to ensure applicable permits for relocating fish are obtained and to capture any fish trapped within an isolated/enclosed area at the work site and safely relocate them to an appropriate location in the same waters. Fish may need to be relocated again, should flooding occur on the site.
- Screen any water intakes or outlet pipes to prevent entrainment or impingement of fish. Entrainment occurs when a fish is drawn into a water intake and cannot escape. Impingement occurs when an entrapped fish is held in contact with the intake screen and is unable to free itself.
 - In freshwater, follow these measures for design and installation of intake end of pipe fish screens to protect fish where water is extracted from fish-bearing waters:
 - Screens should be located in areas and depths of water with low concentrations of fish throughout the year.
 - Screens should be located away from natural or artificial structures that may attract fish that are migrating, spawning, or in rearing habitat.
 - The screen face should be oriented in the same direction as the flow.
 - Ensure openings in the guides and seals are less than the opening criteria to make “fish tight”.
 - Screens should be located a minimum of 300 mm (12 in.) above the bottom of the watercourse to prevent entrainment of sediment and aquatic organisms associated with the bottom area.
 - Structural support should be provided to the screen panels to prevent sagging and collapse of the screen.
 - Large cylindrical and box-type screens should have a manifold installed in them to ensure even water velocity distribution across the screen surface. The ends of the structure should be made out of solid materials and the end of the manifold capped.
 - Heavier cages or trash racks can be fabricated out of bar or grating to protect the finer fish screen, especially where there is debris loading (woody material, leaves, algae mats, etc.). A 150 mm (6 in.) spacing between bars is typical.
 - Provision should be made for the removal, inspection, and cleaning of screens.
 - Ensure regular maintenance and repair of cleaning apparatus, seals, and screens is carried out to prevent debris-fouling and impingement of fish.
 - Pumps should be shut down when fish screens are removed for inspection and cleaning.
- Avoid using explosives in or near water. Use of explosives in or near water produces shock waves that can damage a fish swim bladder and rupture internal organs. Blasting vibrations may also kill or damage fish eggs or larvae.
 - If explosives are required as part of a project (e.g., removal of structures such as piers, pilings, footings; removal of obstructions such as beaver dams; or preparation of a river or lake bottom for installation of a structure such as a dam or water intake), the potential for impacts to fish and fish habitat should be minimized by implementing the following measures:

- Time in-water work requiring the use of explosives to prevent disruption of vulnerable fish life stages, including eggs and larvae, by adhering to appropriate fisheries [timing windows](#).
- Isolate the work site to exclude fish from within the blast area by using bubble/air curtains (i.e., a column of bubbled water extending from the substrate to the water surface as generated by forcing large volumes of air through a perforated pipe/hose), cofferdams or aquadams.
- Remove any fish trapped within the isolated area and release unharmed beyond the blast area prior to initiating blasting
- Minimize blast charge weights used and subdivide each charge into a series of smaller charges in blast holes (i.e., decking) with a minimum 25 millisecond (1/1000 seconds) delay between charge detonations (see Figure 1).
- Back-fill blast holes (stemmed) with sand or gravel to grade or to streambed/water interface to confine the blast.
- Place blasting mats over top of holes to minimize scattering of blast debris around the area.
- Do not use ammonium nitrate based explosives in or near water due to the production of toxic by-products.
- Remove all blasting debris and other associated equipment/products from the blast area.

Figure 1: Sample Blasting Arrangement

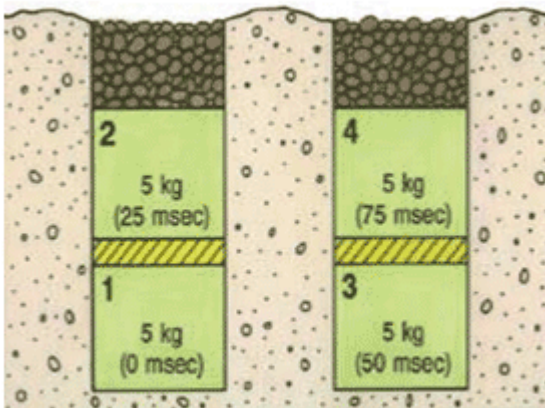

Per Fig. 1: 20 kg total weight of charge; 25 msecs delay between charges and blast holes; and decking of charges within holes.

- Ensure that machinery arrives on site in a clean condition and is maintained free of fluid leaks, invasive species and noxious weeds.

- Whenever possible, operate machinery on land above the high water mark, on ice, or from a floating barge in a manner that minimizes disturbance to the banks and bed of the waterbody.
- Limit machinery fording of the watercourse to a one-time event (i.e., over and back), and only if no alternative crossing method is available. If repeated crossings of the watercourse are required, construct a temporary crossing structure.
- Use temporary crossing structures or other practices to cross streams or waterbodies with steep and highly erodible (e.g., dominated by organic materials and silts) banks and beds. For fording equipment without a temporary crossing structure, use stream bank and bed protection methods (e.g., swamp mats, pads) if minor rutting is likely to occur during fording.
- Wash, refuel and service machinery and store fuel and other materials for the machinery in such a way as to prevent any deleterious substances from entering the water.

Date modified:
2013-11-25

SECTION II

SPECIFICATIONS

FOR FISH SALVAGE

GENERAL
SECTION 201

The Work shall include the capture, salvage and release of fish that are trapped or stranded as the result of the Contractor's operations, at locations identified in the Fish Salvage Plan, and in co-operation with the Essex Region Conservation Authority (E.R.C.A.).

Fish capture shall be performed prior to dewatering, and in such manner that will minimize the injury to the fish.

MATERIALS
SECTION 202

All materials required for fish capture, salvage and release shall be supplied by the Contractor.

CONSTRUCTION
SECTION 203

The Contractor shall not commence any fish capture, salvage and release work until the Fish Salvage Plan has been accepted by the Consultant and the Conservation Authority. All work shall be performed in accordance with the Fish Salvage Plan unless otherwise determined by the Consultant or the Conservation Authority.

The Contractor shall ensure an ice-free pool is maintained throughout all fish capture and release operations.

All fish shall be captured within the area specified and released at an acceptable location in the downstream water body. Fish shall be captured by electro fishing, netting, seining, trapping, or other method acceptable to the Consultant and/or the Conservation Authority.

MEASUREMENT AND PAYMENT
SECTION 204

Payment for this Work will be included in the price bid for drainage work components or made at the lump sum price bid for "Fish Capture and Release". The lump sum price will be considered full compensation for all labour, materials, equipment, tools, and incidentals necessary to complete the Work to the satisfaction of the Consultant.

APPENDIX "REI-B"

5.0 Location

Located along the southern shores of Lake St. Clair in Essex County and in the Essex Region Watershed, the Town of Tecumseh (Study Area) encompasses a geographic area of 9,538.60 hectares (ha) that is bordered by the City of Windsor and the Town of LaSalle on its western side and the Town of Lakeshore to the east and shown on **Figure 1** (Essex Region Conservation Authority (ERCA), 2013). There are four (4) subwatersheds (total area): Pike Creek subwatershed (8,993 ha), Canard River subwatershed (34,776 ha), Tecumseh Area Drainage subwatershed (1,150 ha), Turkey Creek subwatershed (6,112 ha), and Little River subwatershed (6,490 ha) that traverse the lands within the Town's boundaries (ERCA, 2011). Approximately 95.15% (9,079.38 ha) of the landscape consists of anthropogenic features (residential, commercial, agricultural, etc.) while the remaining 4.81% (459.22 ha) is made up of natural areas (terrestrial (4.49%) and other terrestrial (0.32%)) (ERCA, 2013).

There are one hundred and twenty (120) municipal drains measuring 221 kilometers (km) within the Town of Tecumseh (Town of Tecumseh, 2014). Through our background review we identified 3 dominant habitat types surrounding/within the drains that have potential to provide habitat for SAR. Habitats consist of:

Existing Natural Features:

- Forest

Existing Anthropogenic Features:

- Urban (residential, commercial, recreational, right-of-ways)
- Agricultural (row crop, hayfield, old abandoned fields)

Within the Town, there are no forest patches greater than 100 ha in size with the largest being Fairplay Woods (an Environmentally Significant Area (ESA)) which spans a total area of 52.9 ha (ERCA, 2013). There are 2 forest patches that contain 200 m interior forest and 16 patches that contain 100 m interior forest (ERCA, 2013). In accordance with subparagraph i, of paragraph 2, of subsection 6 under Section 23.9 of O.Reg. 242/08, **Drainage Maps** have been prepared that show drain locations, surrounding land use types, proximity to sensitive natural features (e.g. Forest) and potential SAR habitat that exists within the Town's jurisdiction (see **Appendix B**). A list of all the drains and adjacent habitat type(s) has been provided in **Appendix B** following the Drainage Maps. In addition, a **Tecumseh Drain Database** (provided electronically) contains the drain names, adjacent habitat types, and relevant information found during our background review from the MNRF and ERCA.

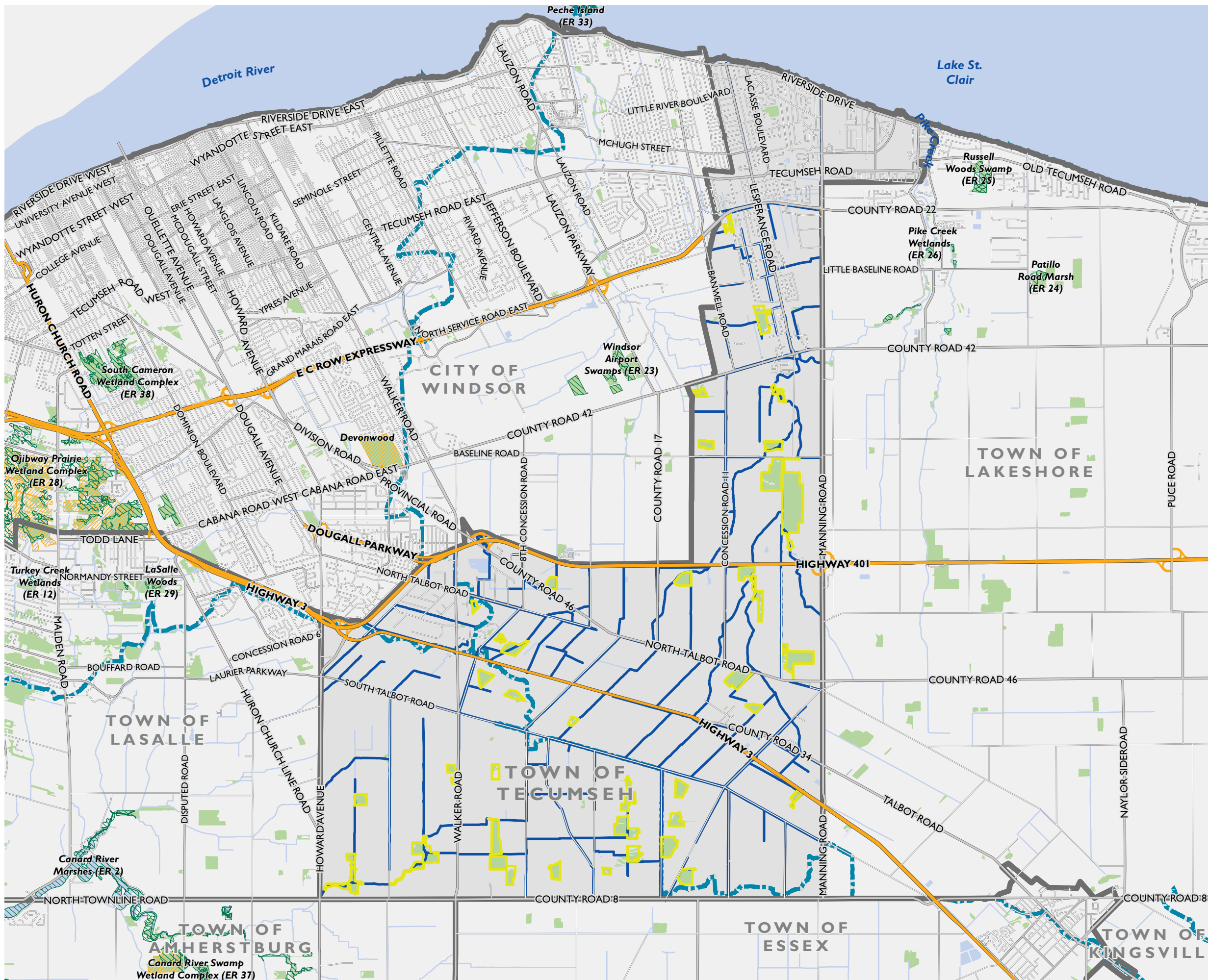

TOWN OF TECUMSEH

NATURAL FEATURES
FIGURE 1

- Mainland
- Provincially Significant Wetland
- ANSI, Life Science
- Natural Heritage System
- Municipal Drain
- Quaternary Watershed
- Water Body
- Woodland

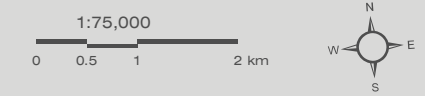
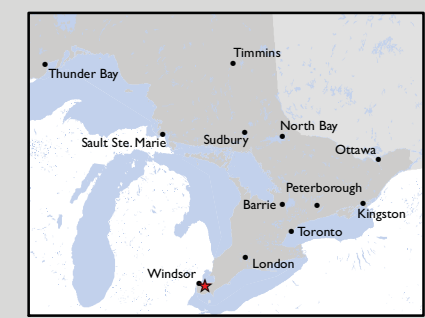

MAP DRAWING INFORMATION:
DATA PROVIDED BY MNR, TOWN OF TECUMSEH

MAP CREATED BY: GM
MAP CHECKED BY: KM/AB
MAP PROJECTION: NAD 1983 UTM Zone 17N



PROJECT: 174938
STATUS: FINAL
DATE: 2017-12-08

6.0 Species at Risk

A review of secondary source information, including the expired MNRF Agreement¹, Natural Heritage Information Centre (NHIC) GIS Database records (i.e. 1 km squares that overlap the Study Area) were reviewed to gather a list of the SAR that have the potential to occur within the Town's boundaries. A total of sixty-six (66) species listed as either endangered or threatened on the SARO list (O.Reg. 230/08) were identified to occur within the Study Area (see **Appendix C**). One Restricted Species Record was also identified in 1988 (NHIC 1 km Square 17LG4478).

The habitat requirements for each of the sixty-six species was cross referenced with habitats identified within the Study Area. A total of Nineteen (19) species listed as endangered or threatened were identified as having potential habitat within the Study Area drains, consisting of Turtles (2 species), Snakes (2 species), Fishes (2 species), Birds (3 species), and Plants (10 species). **Table 2** lists the SAR, preferred habitat type(s) (Forest, Agricultural, Urban or All), need for water presence (requirement for some species), and the dates during the year when the species is likely to be carrying out sensitive life processes, referred to herein as the Restricted Activity Period (RAP).

Four (4) species listed in Table 1, subsection 2, Section 23.9 of O. Reg. 242/08 were identified as having the potential to occur within the Town of Tecumseh drains, these species include: Pugnose Minnow (*Opsopoeodus emiliae*) (1 fish species), False Hop Sedge (*Carex lupuliformis*), Heart-leaved Plantain (*Plantago cordata*) and Scarlet Ammannia (*Ammannia robusta*) (3 plant species). Since these species are listed in Table 1, subsection 2, Section 23.9 of O. Reg. 242/08, this mitigation plan cannot be used for these species and as such, they have not been included in **Table 2** below. Permitting related to these species may be required when working in specific drains. More information on these species, their habitat preferences, known distribution within the area and steps that need to be taken to determine whether a permit is required are outlined in **Appendix D**.

Table 2: Species at Risk with Potential to Occur within the Study Area

Scientific Name	Common Name	ESA ¹	Preferred Habitat Type ²	Restricted Activity Period
Turtles (2 species)				
<i>Emydoidea blandingii</i>	Blanding's Turtle	THR	Forest, Water is present	November 1 to April 30 Important to Note: Activities that require water level reduction cannot occur in areas when and where turtles are hibernating (paragraph 6, subsection 13, under Section 23.9 of O.Reg. 242/08).
<i>Apalone spinifera</i>	Spiny Softshell	THR	Forest, Water is present	

¹ Agreement under Section 23 of O.Reg. 242/08 made under the ESA, 2007 (File # AY-23D-010-10)

Scientific Name	Common Name	ESA ¹	Preferred Habitat Type ²	Restricted Activity Period
Snakes (2 species)				
<i>Pantherophis gloydi</i>	Eastern Foxsnake (Carolinian population)	END	All ³	September 20 to May 31
<i>Thamnophis butleri</i>	Butler's Gartersnake	END	All ³	
Fishes (2 species)				
<i>Notropis anogenus</i>	Pugnose Shiner	END	Water is present	March 15 to June 30
<i>Lepisosteus oculatus</i>	Spotted Gar	THR		
Birds (3 species)				
<i>Dolichonyx oryzivorus</i>	Bobolink	THR	Agricultural	May 1 to July 15
<i>Sturnella magna</i>	Eastern Meadowlark	THR	Agricultural	
<i>Hirundo rustica</i>	Barn Swallow	THR	All ³	
Vascular Plants (10 species)				
<i>Gymnocladus dioicus</i>	Kentucky Coffee-tree	THR	Forest	Not Applicable
<i>Liparis liliifolia</i>	Purple Twayblade	THR	Forest	
<i>Cornus florida</i>	Eastern Flowering Dogwood	END	Forest	
<i>Castanea dentata</i>	American Chestnut	END	Forest	
<i>Juglans cinerea</i>	Butternut	END	Forest	
<i>Morus rubra</i>	Red Mulberry	END	Forest	
<i>Aletris farinosa</i>	Colicroot	THR	Agricultural, Forest	
<i>Smilax rotundifolia</i>	Round-leaved Greenbrier (Great Lakes Plains population)	THR	Forest	
<i>Liatris spicata</i>	Dense Blazing Star	THR	Agricultural	
<i>Symphyotrichum praealtum</i>	Willowleaf Aster	THR	Forest	

¹Endangered Species Act – status as defined by O.Reg. 242/08 as of April 27, 2017; ²Preferred Habitat Types – The habitat types listed are areas where a SAR has the potential to occur. It should be noted that species have the potential to occur outside of these habitats; ³All – Structures such as culverts and bridges may provide suitable habitat for nesting Barn Swallow. Culverts, rip rap and gabion baskets also have the potential to provide nesting and/or hibernaculum for snake species.



7.0 Mitigation Measures

Based on the types of drainage work activities outlined above (in Section 2.0) and the potential for SAR and SAR habitat within and adjacent to the drainage features, the following best practices and mitigation measures are recommended when conducting drainage works. Prior to starting drainage works, the following steps are recommended to help determine the appropriate mitigation/management measures:

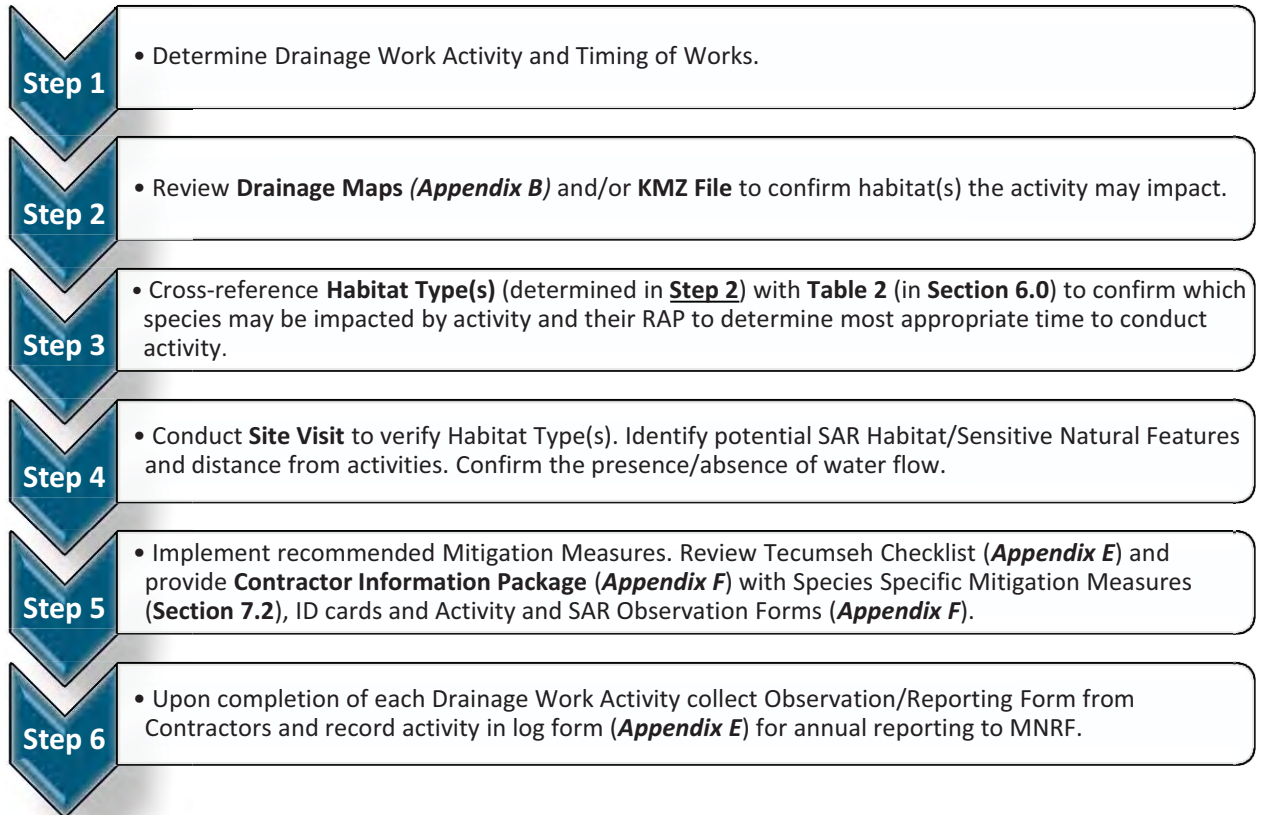

7.1 General Mitigation Measures

The following mitigation measures are recommended to avoid or minimize impacts to the natural environment when conducting drainage works. Following this section species specific mitigation measures are provided.

When planning for drainage works, activities should be planned outside of sensitive timing windows for all wildlife species wherever possible. **Table 2** in Section 6.0 indicates the Restricted Activity Periods for the different SAR having the potential to occur within the Study Area. **Table 3** indicates sensitive timing windows for various types of wildlife (including SAR) based on habitat types.

This information can be used to determine what time(s) of year may be sensitive at a particular site, based on which types of habitat and wildlife are present.

Where possible, activities are recommended to be planned outside of these sensitive time(s); otherwise additional species specific mitigation measures are recommended and/or consultation with the MNRF.

Table 3: Sensitive Timing Windows for other Wildlife Species (including SAR)

Habitat Type	Wildlife	Sensitive Timing Windows
Agricultural (Hayfields and pastures)	Migratory Birds	March through July (breeding season for most species)
Waterbodies	Migratory Birds (including waterfowl)	March through Mid-August
	Turtles and Amphibians	March through Mid-August; and Mid-October through March (for overwintering wildlife, including turtles).
	Mammals	March through mid-August; and Mid-October through March (overwintering wildlife)
	Fish	In-water timing restriction for warmwater fishes March 15 to June 30.
Forest	Migratory Birds	March through mid-August
	Mammals	March through mid-August; and Mid-October through March (overwintering wildlife)
	Snakes	March through mid-August; and Mid-October through March (overwintering wildlife)
Urban	Snakes	March through mid-August; and October through March (overwintering wildlife)
	Mammals	October through March (overwintering wildlife)

The following list provides general measures that are recommended when conducting any drainage work activities:

- **Bats:** The work associated with drainage maintenance covered under this management plan would typically not include the removal of trees. As such, the potential for drainage work activities to impact bat SAR is low. However, if a tree that exhibits a diameter at breast height of 25 cm or greater or a tree that exhibits loose shaggy bark requires removal for drainage works, removal should be completed between November 1 and March 1, outside of the active season for bats. If the tree removal needs to occur during the active season, removal should be completed after dusk.
- Review species specific seasonal timing windows to avoid sensitive periods for species
- Where possible, abide by regulatory timing windows and setback distances and avoid regulated habitat features
- Minimize duration of in-water work (where applicable)

- Any in-stream work should be conducted during periods of low flow
- Schedule work to avoid wet, windy and rainy periods that may increase erosion and sedimentation
- Conduct wildlife sweeps prior to the commencement of drainage work activities to determine if SAR (or other wildlife) are present at the site and engaged in critical life processes (e.g. nesting, etc.)
- Following the wildlife sweep, the area of activity is to be isolated with silt fencing to keep SAR and other wildlife from entering the work space area.
- Develop and implement an erosion and sediment control plan for the site that minimizes the risk of sedimentation to the drain during all phases of an activity. Erosion and sediment control measures should be maintained until all disturbed ground has been permanently stabilized, suspended sediment has resettled to the bed of the drain of settling basin and runoff water is clear. Following the DFO's Measures to Avoid Harm (as outlined on DFO's website: <http://www.dfo-mpo.gc.ca/pnw-ppe/measures-mesures/measures-mesures-eng.html>), an erosion and sediment control plan, where applicable, is to include the following:
 - Installation of effective erosion and sediment control measures before starting work to prevent sediment from entering the drain
 - Measures for managing water flowing onto the site, as well as water being pumped/diverted from the site such that sediment is filtered out prior to the water entering the drain
 - Site isolation measures, where required, to contain suspended sediment
 - Measures for containing and stabilizing waste materials generated from activities are stored away from any water bodies and prevent materials from re-entering water bodies
 - Erosion and sediment control measures are inspected and maintained on a regular basis during drainage works
 - Any damages to erosion and control measures are to be repaired immediately
 - Removal of non-biodegradable erosion and sediment control materials once site has been stabilized
- ***Phragmites*** is a non-native perennial grass species that has been observed throughout much of the province and Tecumseh, developing tall dense stands that degrade wetlands and other features by outcompeting native vegetation and changing habitat. To further prevent the spread and introduction of this unwanted species in the province, the provincial government has regulated invasive *Phragmites* as restricted under the *Invasive Species Act*, 2015. Restricted species under the Act, prohibits i) the transport of species into any provincial park and conservation reserve and ii) the deposit or release of species in Ontario. For further information on the *Invasive Species Act*, 2015 please visit: www.ontario.ca/invasionON. It is recommended that care be taken when working in areas with *Phragmites* and efforts be taken to prevent further spread of species through equipment transfer. Methods to prevent the spread of *Phragmites* while conducting drainage works should include:
 - Inspection of vehicles, equipment and heavy machinery thoroughly inside and out for accumulation of dirt, plant material or snow/ice, including the underside of vehicles, radiators, spare tires, foot wells and bumpers before entering onto a site. Remove any guards, covers, plates or other easy to remove external equipment;



- Inspections should be completed when: moving vehicles out of local area of operation; moving machinery between properties or sites within the same property where invasive species may be present or known to occur; and using machinery along roadsides, in ditches and along watercourses.
- Vehicles, equipment and heavy machinery should be cleaned: before moving out of local area where invasive species has been identified or known to occur; and when accumulations of dirt, plant material or snow/ice has been observed.
- Clean vehicles, equipment and heavy machinery in an area where risk of contamination is low, ideally on a mud free hard surface, at least 30 m away from any watercourse, waterbody, wetland or other natural area, if possible. Where risk of runoff is high, cleaning stations should be contained by sediment fence as per standard erosion and sediment control specifications.
- Remove large accumulations of dirt, using a compressed air device, high pressure hose or other device as necessary. Clean the vehicle starting at the top and working down, with particular attention to the undersides, wheels, wheel arches, guards, chassis, engine bays, grills and other attachments.
- Clean inside vehicles by sweeping, vacuuming or using compressed air device including floor, foot wells, pedals, seats and under the seats.

Additional details on cleaning equipment and/or managing invasive species can be found in the Clean Equipment Protocol for Industry (J. Halloran, et al., 2013) and online at the Government of Ontario's website: <https://www.ontario.ca/page/stop-spread-invasive-species>.

7.2 Species Specific Mitigation Plans

In the event a SAR or SAR habitat has been identified within the proposed area for drainage work activity, the following information should be clearly conveyed to the on-site staff as part of the drainage works protocol, via notes or plans and on-site briefings with construction/personnel:

- Schedule for pre-construction activities such as wildlife inspections, silt fencing installation and contractor briefing.
- Description of wildlife mitigation measures to be used during drainage work activities, including:
 - Placement and specifications of required protection measures (e.g. fencing, signage)
 - Phasing and direction of site clearing activities
 - Any recommendations regarding access routes for equipment, vehicle parking, materials, stockpiling, etc.
- Guidance on what to do in the event of a wildlife encounter, including SAR and arrangements for dealing with injured or orphaned animals (as indicated in **Table 5** and **Appendix F**). This guidance should be summarized in a handout suitable for quick reference by on-site staff.
- SAR awareness training should be provided to all on-site staff, including truck drivers.

In the Contractor Information Package (**Appendix F**) Dillon has provided SAR identification sheets for SAR with the potential to occur within the Study Area.

7.2.1 Species Specific Mitigation Measures for Snake Species

Snake species can be found in a variety of habitat types and most of the drainage work activities have the potential to encounter snakes. Particular attention should be given when conducting works on catch basins, culverts, rip rap and crossing structures, as snakes carry out sensitive life processes in structures such as these. **Table 4** shows the sensitive timing windows for snake species when carrying out life processes related to hibernation and staging.

Table 4: Sensitive Timing Windows for Snake Species

Month	Jan			Feb			Mar			Apr			May			Jun			Jul			Aug			Sep			Oct			Nov			Dec					
Date Codes ¹	E	M	L	E	M	L	E	M	L	E	M	L	E	M	L	E	M	L	E	M	L	E	M	L	E	M	L	E	M	L	E	M	L	E	M	L	E	M	L
Hibernation	█																																						
Staging										█																													

¹Monthly intervals: E = Early (days 1-10); M = Middle (days 11-20); L = Late (days 21-31). Adapted from the Seasonal Timing Windows Chart in the MNRF Agreement under Section 23 of O.Reg. 242/08 made under ESA, 2007 (File #: AY-23D-010-10).

Table 5 below outlines the recommended mitigation measures to avoid impacts to snake species during and outside of RAP. Photographs of habitat observed within and adjacent to drains that have the potential to support SAR snakes, have been included in **Appendix G** (Photographs #1 - 4).



Table 5: Mitigation Measures for Snake Species

Common Name	Recommended Mitigation Measures to Avoid Impacts to SAR Snakes in Study Area
Eastern Foxsnake (Carolinian population) and Butler's Gartersnake	<ul style="list-style-type: none"> • Preconstruction planning that includes review for potential habitat. • During site visit, verify if attributes of regulated habitat occur and delineate where possible. • Establish constraints for activities, where possible, that abide by timing windows and setback distances and avoid regulated habitat features • Narrow construction footprint if possible. • Flag or fence off environmentally sensitive areas prior to drainage work activity. Bury fencing a minimum of 10 – 20 cm and vertical height of at least 60 cm. Note, stakes should be installed on the activity side to prevent snake use of stakes to climb fence. • Complete wildlife sweep within the exclusion area following fence installation to ensure no trapped wildlife. • Staff/workers conducting drainage works should be trained in snake species identification and procedures if encountered (review and sign off form in Contractor Information Package) • One staff member/worker or qualified biologist should be trained in proper snake handling procedures and protocols outlined in Section 2 of the Ontario Species at Risk Handling Manual: For Endangered Species Act Authorization Holders (Included in the Contractor Information Package). This person should be onsite at all times (when required) for the potential capture, temporary holding, transfer and release of any snakes encountered during construction. A minimum of two holding tubs and cotton sacks should be onsite at all times. • Prior to commencement of daily drainage work activity, the area should be cleared of snakes through machinery inspections (e.g. wheels, engine compartment) each morning and after machinery is left idle for more than one (1) hour if left on site during the snake active season. • If a nest is uncovered during drainage work activity: <ul style="list-style-type: none"> ◦ Collect any displaced or damaged eggs and transfer them to a holding tub ◦ Capture and transfer all injured dispersing juveniles of that species into a light-coloured drawstring cotton sack ◦ Place all cotton sacks with the captured injured individuals into a holding tub out of direct sunlight ◦ Immediately contact the MNRF to seek direction and to arrange for transfer of the injured individuals ◦ Immediately stop any disturbance to the nest site and loosely cover exposed portions with soil or organic material to protect the integrity of the remaining individuals ◦ Do not drive over the nest site or conduct any activities within 5 m of the nest site ◦ Do not place any dredged materials removed from drainage works on top of the nest site ◦ Mark out the physical location of the nest site but not by any means that might increase the susceptibility of the nest to predation or poaching ◦ Where there are no collected eggs or captured individuals, contact the MNRF within 24 hours to provide information on the location of the nest • Any injured captured snakes should be stored outside of direct sunlight and the MNRF should immediately be contacted to seek direction and to arrange for transfer. MNRF may require transfer to the nearest MNRF authorized Wildlife Rehabilitator. Contact Information for Authorized Wildlife Rehabilitator can be found in SAR Information Sheets (Appendix F). • If conducting drainage works during a species sensitive timing window and one or more individuals belonging to a snake species is encountered or active hibernacula is discovered: <ul style="list-style-type: none"> ◦ Trained staff/worker or qualified biologist shall capture and transfer all injured and uninjured individual snakes of that species into individual light-coloured, drawstring cotton sacks ◦ Place cotton sacks into a holding tub ◦ Ensure that the holding tub with captured individuals is stored at a cool temperature to protect snakes from freezing until the individuals can be retrieved or transferred ◦ If an active hibernacula is uncovered cease all work and immediately, contact MNRF to seek advice and arrange for transfer and/or removal • If conducting drainage works outside of a species sensitive timing window and one or more individuals belonging to a snake species is encountered: <ul style="list-style-type: none"> ◦ Briefly stop the activity for a reasonable period of time to allow any uninjured individual snakes of that species to leave the work area ◦ If the individuals do not leave the work area after the activity is briefly stopped, trained staff/worker or qualified biologist shall capture all uninjured individuals and release them in accordance with the methods outlined below ◦ Where circumstances do not allow for the immediate release of captured uninjured individuals, they may be transferred into individual, light-coloured, drawstring cotton sacks before placing them into a holding tub which shall be stored out of direct sunlight for a maximum of 24 hours before releasing them in accordance with the methods outlined below ◦ Capture and transfer any individuals injured as a result of conducting drainage works into a holding tub separate from any holding tub containing uninjured individuals ◦ Store all captured injured individuals out of direct sunlight and immediately contact the MNRF to seek direction and to arrange their transfer • Uninjured individuals captured during drainage works, are to be released within 24 hours of capture, in an area immediately adjacent to the drainage works with natural vegetation cover within 50 m and out of harm's way (as per subsections 2.3 and 2.4 of Handling Manual included in the Contractor Information Package; Appendix F).

Common Name	Recommended Mitigation Measures to Avoid Impacts to SAR Snakes in Study Area
	<ul style="list-style-type: none"> • Uninjured individuals captured during drainage works, are to be released within 24 hours of capture, in an area immediately adjacent to the drainage works with natural vegetation cover within 50 m and out of harm's way (as per subsections 2.3 and 2.4 of Handling Manual included in the Contractor Information Package; Appendix F). • Where one or more individuals belonging to a snake species is killed as a result of drainage work activity, or a person finds a deceased individual of a snake species, the following measures should be followed: <ul style="list-style-type: none"> ○ Collect and transfer any dead individuals into a holding tub outside of direct sunlight; and, ○ Contact the MNRF within 72 hours to seek direction and to arrange for the transfer of the carcasses of the dead individuals. • If the methods of handling snakes outlined in subsection 2.3 and 2.4 of the Handling Manuals are not applicable due to a snake's injuries, use a shovel or flat object to pick up the snake, ensuring that injured areas are supported and place in a large plastic bin or bucket with a lid with air holes. Immediately transport the turtle to an MNRF authorized veterinarian or wildlife rehabilitator and contact the MNRF. Contact Information for Authorized Wildlife Rehabilitator can be found in Appendix F and on SAR Information Sheets (Appendix F). • Complete a SAR Encounter Reporting Form included in Contractor Information Package (Appendix F).

7.2.2 Species Specific Mitigation Measures for Turtle Species

Turtles can generally be found associated with large slow moving water features that have logs or stumps for basking. For nesting, turtles prefer moist well drained, loose soils for digging and on a gradual typically south facing slope. Species such as Blanding’s Turtle and Spiny Softshell hibernate underwater in permanent waterbodies. Sensitive timing windows for turtle species includes the nesting period and has been provided in **Table 6**.

When conducting drainage works where there is potential for turtle species to be hibernating, water level **cannot be reduced** as per Paragraph 6 of subsection 13 of Section 23.9 of O.Reg. 242/08.

Table 6: Restricted Activity Period for Turtle Species

Month	Jan			Feb			Mar			Apr			May			Jun			Jul			Aug			Sep			Oct			Nov			Dec								
Date Codes ¹	E	M	L	E	M	L	E	M	L	E	M	L	E	M	L	E	M	L	E	M	L	E	M	L	E	M	L	E	M	L	E	M	L	E	M	L	E	M	L	E	M	L
Hibernation																																										

¹Monthly intervals: E = Early (days 1-10); M = Middle (days 11-20); L = Late (days 21-31). Adapted from the Seasonal Timing Windows Chart in the MNRF Agreement under Section 23 of O.Reg. 242/08 made under ESA, 2007 (File #: AY-23D-010-10).

In **Table 7** below, the recommended mitigation measures to avoid impacts to turtle species during and outside sensitive timing windows and what to do when turtles or turtle nests are encountered is provided. Photographs of habitat observed within and adjacent to drains that have the potential to support SAR Turtles, have been included in **Appendix G** (Photographs #5 - 6).



Table 7: Mitigation Measures for Turtle Species

Common Name	Recommended Mitigation Measures to Avoid Impacts to SAR Turtles within the Study Area
Blanding's Turtle	<ul style="list-style-type: none"> • Preconstruction planning that includes review for potential habitat. • During site visit, verify if attributes of regulated habitat occur and delineate where possible. • Establish constraints for activities, where possible, that abide by timing windows, setback distances and avoid regulated habitat features. • Narrow construction footprint if possible. • Flag or fence off environmentally sensitive areas prior to drainage work activity. Bury fencing a minimum of 10 – 20cm and vertical height of at least 60 cm. • Complete wildlife sweep within the exclusion/construction area following fence installation to ensure no trapped wildlife. • Staff/workers conducting drainage works should be trained in turtle species identification and procedures if encountered (Review and sign off form in the Contractor Information Package; Appendix F). • One staff member/worker or qualified biologist should be trained in proper turtle handling procedures and protocols outlined in Section 1 of the Ontario Species at Risk Handling Manual: For Endangered Species Act Authorization Holders (provided in the Contractor Information Package; Appendix F). This person should be onsite at all times (when required) for the potential capture, temporary holding, transfer and release of any turtles encountered during construction. A minimum of two holding tubs and cotton sacks should be onsite at all times. • If construction is planned to commence during the turtle nesting period, prior to site preparation a turtle nesting search should be completed to identify turtle nests. If nests are encountered, the MNRF must be consulted immediately. Nests should be relocated to an appropriate facility for incubation with MNRF approval. Contact information for MNRF Authorized Wildlife Rehabilitator can be found in SAR Information Sheets (Appendix F). • Drainage work activity related to excavation of sediment or disturbance to banks should be avoided during the sensitive timing windows for turtles. • During turtle hibernation periods, water in drains or ditches cannot be reduced. • Prior to commencement of daily activity, the area should be cleared of turtles and turtle nests by a specially trained staff member or qualified biologist.
Spiny Softshell	<ul style="list-style-type: none"> • Do not disturb a turtle encountered laying eggs and do not conduct activities within 20 m of the turtle while it is laying eggs. • If conducting drainage works during a species sensitive timing window and one or more individuals belonging to a turtle species is encountered: <ul style="list-style-type: none"> ○ Trained staff/worker or qualified biologist shall capture and transfer all injured and uninjured individuals of that species to a holding tub ○ Capture and transfer all individuals injured as a result of the drainage work activity into a holding tub separate from any holding tub containing uninjured individuals ○ Ensure that the holding tub with captured individuals is stored at a cool temperature until the individuals can be retrieved or transferred ○ Contact the MNRF immediately to seek advice and arrange for transfer and/or removal • If a nest is uncovered during construction, immediately stop all activity near the nest. Cover the nest with soil or organic material. Do not drive within 5 m of the nest and contact the MNRF within 24 hours if no eggs or individuals were captured/collected. • Isolate material stockpile areas with fencing. • Any injured captured turtles should be stored outside of direct sunlight and the MNRF should immediately be contacted to seek direction and to arrange for transfer. • Machinery should be inspected each morning (e.g. under vehicles) for presence of turtles. • Uninjured individuals captured during drainage works, are to be released within 1 hour of capture, out of harm's way no more than 125 m of where it was found, unless absolutely necessary. If it is not possible to relocate the turtle within 125 m of the capture location, contact the MNRF for further direction. MNRF may require transport of turtle(s) to MNRF Authorized Wildlife Rehabilitator or Veterinarian. Contact information can be found in Appendix F. • If the methods of handling turtles outlined in subsection 1.3 of the Handling Protocol are not possible due to a turtle's injuries, use a shovel or flat object to pick up the turtle, ensuring that injured areas are supported and place in a large plastic bin or bucket with a lid with air holes. Immediately transport the turtle to an MNRF Authorized Wildlife Rehabilitator or Veterinarian and contact the MNRF. Contact Information for Authorized Wildlife Rehabilitator can be found in Appendix F and on SAR Information Sheets (Appendix F). See subsection 1.7 of the Handling Manual (included in the Contractor Information Package; Appendix F) for more details. • Complete a SAR Encounter Reporting Form included in the Contractor Information Package (Appendix F).

7.2.3 Species Specific Mitigation Measures for Aquatic Species

Review of background information including, DFO’s Aquatic SAR Mapping (Map 29 of 33), NHIC and MNRF Agreement² identified 10 fish and 10 mollusc species listed as endangered or threatened under the ESA, 2007 with occurrence records within and/or adjacent to the Study Area. Of the 20 aquatic SAR identified only two fish species have been included in the Plan based on the presence of suitable habitat within the Study Area drains.

Although suitable habitat for SAR mussel species was not identified during our background review and site visits, if at any time a mussel species (of any type) are encountered, stop work and contact DFO for direction on how to proceed. A SAR Information Sheet for mussels species found during the background review has been provided in **Appendix F**.

Watercourses and drains identified during the background review and subsequent field investigations found all features to be of warm water thermal regime and to support warm water fish species. **Table 8** below indicates the in-water timing window restriction for warm water fish species. **Table 9** provides a list of recommended measures to follow to avoid impacts to fish species. As previously mentioned, activities that affect a species listed in Table 1, subsection 2, Section 23.9 of O. Reg. 242/08 still require a permit to conduct drainage works (see **Appendix D** for details). DFO’s *Guidance for Maintaining and Repairing Municipal Drains in Ontario version 1.0* (2017) document should be consulted when conducting all drainage works.

Table 8: In-water Timing Window Restriction for Warm Water Fish Species

Month	Jan			Feb			Mar			Apr			May			Jun			Jul			Aug			Sep			Oct			Nov			Dec								
Date Codes ¹	E	M	L	E	M	L	E	M	L	E	M	L	E	M	L	E	M	L	E	M	L	E	M	L	E	M	L	E	M	L	E	M	L	E	M	L	E	M	L	E	M	L
In-water Restriction																																										

¹Monthly intervals: E = Early (days 1-10); M = Middle (days 11-20); L = Late (days 21-31). Adapted from the Seasonal Timing Windows Chart in the MNRF Agreement under Section 23 of O.Reg. 242/08 made under ESA, 2007 (File #: AY-23D-010-10).

² Agreement under Section 23 of O.Reg. 242/08 made under the ESA, 2007 (File # AY-23D-010-10).



Table 9: Mitigation Measures for Aquatic Species

Common Name	Recommended Mitigation Measures to Avoid Impacts to SAR Aquatic Species within the Study Area
Pugnose Shiner	<ul style="list-style-type: none"> • Consult with MNRF if in-water timing window restrictions cannot be adhered to. • Allow for fish salvage within the isolated work area prior to dewatering. • Limit duration of in-water work as much as possible. • Conduct in-stream work during periods of low flow to reduce the risk to fish and their habitat and to allow work in-water to be isolated from flows. • Schedule work to avoid wet, windy, and rainy periods that may increase erosion and sedimentation. Suspend in-stream work immediately if sedimentation is detected. • Implement water quality monitoring if required. • Ensure equipment is clean and free of leaks. Wash, refuel and service machinery and store fuel and other materials for the machinery in such a way as to prevent any deleterious substances from entering the water. • Alter activities to reduce disturbance to species and habitat and follow current DFO Measures to Avoid Harm
Spotted Gar	<ul style="list-style-type: none"> • If federally listed SAR fish are encountered or have the potential to be present, contact the DFO to review next steps. • If SAR encountered, complete a SAR Encounter Reporting Form that will be included in the annual reporting.



Based on our review of potential SAR birds to occur within the Study Area, the following mitigation measures are recommended while conducting drainage work activities:

Table 11: Mitigation Measures for Bird Species

Common Name	Recommended Mitigation Measures to Avoid Impacts to SAR Birds within the Study Area
Bobolink	<ul style="list-style-type: none"> • Planning activities should include review of area for potential habitat (including box culverts and bridges for Barn Swallow nests). • Limit construction footprint where possible. • Conduct work outside of the RAP for birds where possible.
Eastern Meadowlark	<ul style="list-style-type: none"> • Pre-construction activities should include bird nest sweeps if activities occur during migratory bird sensitive timing window identified in Table 10, above. • Protect active nests by flagging or fencing off an appropriate setback distance. • Suspend activity if active habitat is discovered that cannot be adequately setback from.
Barn Swallow	<ul style="list-style-type: none"> • Maintain habitat connections where possible during activities. • Implement measures to restore lost habitat/ habitat connections. • If sensitive habitat is on site, a qualified biologist should be on site daily. • If SAR encountered, complete a SAR Encounter Reporting Form that will be included in the annual submission to the MNRF.

7.2.5 Species Specific Mitigation Measures for Vegetation Communities

Potential impacts to plant SAR may include trampling by personnel or equipment, alteration of growing conditions (e.g. soil compaction, sunlight availability, and moisture regime), disturbance to localized seed bank and introduction of invasive species. Mitigation measures that will be incorporated during drainage work activities to minimize the impacts to adjacent forest communities and SAR vegetation include:

- Planning activities should include review of area for identification of potential SAR vegetation.
- Limit construction footprint where possible to minimize the disturbance to plant species.
- Installing temporary erosion and sediment control measures prior to activity, and maintaining them throughout activity, including routinely inspecting and repairing them, as required. Enhanced sediment and erosion control measures will be implemented for sensitive areas where SAR habitat has been identified within and abutting the work site.
- Vegetation that does not require removal for the purposes of construction will be protected through the installation and maintenance of temporary vegetation protection fencing (e.g. snow fencing or erosion sediment control fencing). This includes protection of any SAR trees identified.
- Equipment, materials and other construction activities will not be permitted in zones delineated for protection.
- If drainage work activity cannot be undertaken without disturbing a SAR plant(s), the Town should contact the MNRF for additional site-specific measures.
- Operational procedures and Best Management Practices for handling material and excess material, and spill prevention will be implemented. Vehicular and equipment maintenance and refuelling will be carried out in a controlled manner, and where applicable, at designated maintenance areas. Refuelling will not be permitted within 30 m of any forest, or watercourse.
- Stabilize and re-vegetate exposed soil surfaces as soon as possible following activities, using native groundcover seed mixes and plantings.



SCHEDULE C
MITIGATION PLAN

The Municipality shall undertake measures to minimize adverse effects on species at risk in accordance with the general conditions described in Part B and taxa-specific conditions described in Part C, and the monitoring and reporting requirements described in Part D of this Mitigation Plan.

PART A. DEFINITIONS

1. Definitions:

1.1. In this Schedule, the following words shall have the following meanings:

"DFO" means Fisheries and Oceans Canada;

"MNR" means the Aylmer District Office of the Ministry of Natural Resources;

"Contact" means to contact the MNR in accordance with the notification/contact schedule provided to the Municipality by the MNR Designated Representative from time to time;

"Holding Tub" means a large, light-coloured container fitted with a non-airtight latching lid approved by the MNR for the temporary storage of captured snakes, turtles, amphibians, birds or eggs;

"Interagency Notification Form" means the form issued by DFO, available at www.dfo-mpo.gc.ca, which is required to be completed when a drain is being maintained or constructed;

"Monitoring and Reporting Form" means the document that must be completed by the Municipality in accordance with Part D to this Schedule and will be provided to the Municipality;

"Ontario Operational Statement" means one of the documents issued by DFO, available at www.dfo-mpo.gc.ca, that sets out the conditions and measures to be incorporated into a project in order to avoid negative impacts to fish and fish habitat in Ontario, as modified from time to time;

"Process Charts" means the charts attached as Part E to this Schedule which describe the steps set out in this Mitigation Plan;

"Seasonal Timing Windows Chart" means the chart attached as Part G to this schedule which describes the Sensitive Periods applicable to each Taxonomic Group;

"Sensitive Area" means a geographic area in the Municipality where additional mitigation measures are required to be undertaken for one or more Taxonomic Groups;

"Sensitive Areas Map" means any one of the maps attached as Part F to this schedule which sets out the applicable Sensitive Areas;

"Sensitive Period" means a time of year set out in the Seasonal Timing Windows Chart during which taxa-specific mitigation measures are required to be undertaken for a Taxonomic Group because of ambient air/water temperatures, water-levels or important life-history stages;

"Taxonomic Group" means the distinct group comprising one or more Species based on their taxonomic relationship and common approaches to mitigating adverse effects (i.e., fish, mussels, turtles, snakes, amphibians, birds or plants); and

"Work Zone" means the geographic area in the Municipality where an Activity in respect of one of the Drainage Works is being conducted.

- 1.2. For greater certainty, any defined terms that are not defined in section 1.1 have the same meanings as in the Agreement.

PART B. GENERAL MEASURES TO MINIMIZE ADVERSE EFFECTS

2. Process Charts

- 2.1. The general steps set out in this Part B are visually described in the Process Charts (Part E).

3. Review of Documentation

- 3.1. Prior to conducting any Activities in respect of the Drainage Works the Municipality shall determine if conditions apply to the place, time or manner in which the Municipality wishes to pursue them by reviewing:
 - (a) the Sensitive Areas Maps (Part F) to determine if the Work Zone for the proposed Activities will occur within a Sensitive Area;
 - (b) the DFO Reference Guide for Fish and Mussel Species at Risk Distribution Maps: A Referral Review Tool for Projects Affecting Aquatic Species at Risk;
 - (c) the Seasonal Timing Windows Chart (Part G) to determine if the proposed Activities will occur during a Sensitive Period for one or more of the Taxonomic Groups; and
 - (d) the Process Charts to determine if prior notification is required;
 - (e) the mitigation measures for each applicable Taxonomic Group in Part C to determine what additional site-specific mitigation measures, if any, are required.
- 3.2. The Municipality shall document the results of the review undertaken in accordance with section 3.1 using the Monitoring and Reporting Form.

4. Sensitive Areas Maps

- 4.1. The Sensitive Areas Maps contain sensitive information about the distribution of species at risk, are provided for the sole purpose of informing this Agreement and are not to be copied or distributed for any other purposes or to any other party without the prior written authorization of the MNR Designated Representative.

5. Prior Notification to Seek Direction

- 5.1. If, after completing the review of documents described in section 3.1, the Municipality determines that the proposed Activities will be undertaken:
 - (a) in a place;
 - (b) at a time; or
 - (c) in a manner,

that requires prior notification in accordance with the Process Charts, the Municipality shall provide prior notification to the MNR in order for the MNR to determine if the Municipality must undertake additional site-specific or Species-specific mitigation

measures to minimize adverse effects on the Species and, if applicable, to identify such measures.

- 5.2. The prior notification under section 5.1 shall include a completed Interagency Notification Form:
 - (a) in respect of maintenance/repair where the proposed Activities are being undertaken pursuant to subsection 3(18) or section 74 of the *Drainage Act*, or
 - (b) in respect of construction/improvement where the proposed Activities are being undertaken pursuant to section 77 or 78 of the *Drainage Act*.
- 5.3. Where an Activity is undertaken in accordance with section 124 of the *Drainage Act* and would otherwise have required prior notification under section 5.1, the Municipality shall Contact the MNR by email prior to the commencement of the Activity, and complete and submit the applicable Interagency Notification Form within one week of the Activity's completion, unless otherwise directed in writing by the MNR Designated Representative.

6. General Mitigation Measures

- 6.1. Notwithstanding that prior notification or additional mitigation measures may be required in accordance with this schedule, in undertaking any Activity at any time in respect of the Drainage Works the Municipality shall:
 - (a) undertake the mitigation measures for sediment control and for erosion control and bank stabilization set out in The Drain Primer (Cliff Evanitski 2008) published by DFO (ISBN 978-0-662-48027-3), unless otherwise authorized in writing by the MNR Designated Representative;
 - (b) use net free, 100% biodegradable erosion control blanket for all erosion control or bank stabilization done in conjunction with their Activities or, if authorized in writing by the MNR Designated Representative, alternative erosion control blankets that provide equal or greater protection to individual Species; and
 - (c) where applicable, follow the guidelines set out in the following Ontario Operational Statements:
 - (i) Beaver Dam Removal;
 - (ii) Bridge Maintenance;
 - (iii) Culvert Maintenance;
 - (iv) Isolated Pond Construction;
 - (v) Maintenance of Riparian Vegetation in Existing Right of Ways; and
 - (vi) Temporary Stream Crossing.

PART C. TAXA-SPECIFIC MEASURES TO MINIMIZE ADVERSE EFFECTS

ADDITIONAL MITIGATION MEASURES FOR FISH SPECIES

7. Activities undertaken in Sensitive Areas for Fish

- 7.1. Subject to section 7.2, where a proposed Activity will occur in a Sensitive Area for a fish Species, the Municipality shall Contact the MNR to seek further direction.
- 7.2. Section 7.1 does not apply where the applicable Drainage Works are:
 - (a) in a naturally dry condition;
 - (b) classified as a Class F drain under DFO's *Class Authorization System for the Maintenance of Agricultural Municipal Drains in Ontario* (ISBN 0-662-72748-7); or
 - (c) a closed drain.

ADDITIONAL MITIGATION MEASURES FOR MUSSEL SPECIES

8. Activities undertaken in Sensitive Areas for Mussels

- 8.1. Subject to section 8.2, where a proposed Activity will occur in a Sensitive Area for a mussel Species, the Municipality shall Contact the MNR to seek further direction.
- 8.2. Section 8.1 does not apply where the applicable Drainage Works are:
 - (a) in a naturally dry condition;
 - (b) classified as a Class F drain in DFO's *Class Authorization System for the Maintenance of Agricultural Municipal Drains in Ontario* (ISBN 0-662-72748-7); or
 - (c) a closed drain.

ADDITIONAL MITIGATION MEASURES FOR TURTLE SPECIES

9. Training and Required On Site Materials for Turtles

- 9.1. The Municipality will ensure any person:
 - (a) involved in the capture, temporary holding, transfer and release of any turtle Species has received training in proper turtle handling procedures; and
 - (b) who undertakes an Activity has a minimum of two Holding Tubs and cotton sacks on site at all times.

10. Activities undertaken in Sensitive Areas and Sensitive Periods for Turtles

- 10.1. Subject to section 10.2, where a proposed Activity will occur in a Sensitive Area for any turtle Species and during a Sensitive Period for that Species, the Municipality shall:
 - (a) not undertake any Activities that include the excavation of sediment or disturbance to banks during the applicable Sensitive Period unless otherwise authorized;
 - (b) undertake Activities in accordance with any additional site-specific measures provided in writing by the MNR Designated Representative;
 - (c) avoid draw-down and de-watering of the Sensitive Area during the applicable Sensitive Period; and

- (d) if authorized by the MNR Designated Representative under (a) above to undertake Activities that include excavation of sediment or disturbance of banks, in addition to any other measures required under (b) above, ensure any person undertaking an Activity has at least two Holding Tubs on site at all times.

10.2. Section 10.1 does not apply where the applicable Drainage Works are:

- (a) in a naturally dry condition;
- (b) classified as a Class F drain in DFO's *Class Authorization System for the Maintenance of Agricultural Municipal Drains in Ontario* (ISBN 0-662-72748-7); or
- (c) a closed drain.

11. Measures for Encounters with Turtles During a Sensitive Period

- 11.1. Where one or more individuals belonging to a turtle Species is encountered in the undertaking of an Activity in any part of a Work Zone (including, but not limited to, a Sensitive Area) during a Sensitive Period for that Species, the Municipality shall:
- (a) capture and transfer all uninjured individuals of that Species into a Holding Tub;
 - (b) capture and transfer all individuals injured as a result of the Activities into a Holding Tub separate from any Holding Tub containing uninjured individuals;
 - (c) ensure that the Holding Tubs with the captured individuals are stored at a cool temperature to prevent freezing until the individuals can be transferred; and
 - (d) immediately Contact the MNR to seek direction and to arrange for the transfer of the individual turtles.

12. Measures for Encounters with Turtles Laying Eggs or Nest Sites

- 12.1. Where one or more individuals belonging to a turtle Species laying eggs, or an active nest site of any turtle Species, is encountered in undertaking an Activity in a Work Zone, the Municipality shall:
- (a) not disturb a turtle encountered laying eggs and not conduct any Activities within 20 metres of the turtle while it is laying eggs;
 - (b) collect any displaced or damaged eggs and capture any injured dispersing juveniles and transfer them to a Holding Tub;
 - (c) store all captured injured individuals and collected eggs out of direct sunlight;
 - (d) immediately Contact the MNR to seek direction and to arrange for the transfer of any injured individuals and eggs;
 - (e) immediately stop any disturbance to the nest site and recover exposed portions with soil or organic material to protect the integrity of the remaining individuals;
 - (f) not drive any equipment over the nest site or conduct any Activities within 5 metres of the nest site;
 - (g) not place any dredged materials removed from the Drainage Works on top of the nest site;
 - (h) mark out the physical location of the nest site for the duration of the project but not by any means that might increase the susceptibility of the nest to predation or poaching; and
 - (i) where there are no collected eggs or captured individuals, record relevant information and Contact the MNR within 72 hours to provide information on the location of the nest site.

13. Measures for Encounters with Turtles Outside of a Sensitive Period

- 13.1. Where one or more individuals belonging to a turtle Species is encountered while undertaking an Activity in any part of a Work Zone (including, but not limited to, a Sensitive Area) but outside of any Sensitive Period for that Species, the Municipality shall:
- (a) briefly stop the Activity for a reasonable period of time to allow any uninjured individual turtles of that Species to leave the Work Zone;
 - (b) where individuals do not leave the Work Zone after the Activity is briefly stopped in accordance with (a) above, capture all uninjured individuals and release them in accordance with section 14.1;
 - (c) where circumstances do not allow for their immediate release, transfer captured uninjured individuals for a maximum of 24 hours into a Holding Tub which shall be stored out of direct sunlight and then release them in accordance with section 14.1;
 - (d) capture and transfer any individuals that have been injured into a Holding Tub separate from any Holding Tub containing uninjured individuals; and
 - (e) store all captured injured individuals out of direct sunlight and immediately Contact the MNR to seek direction and to arrange for their transfer.

14. Release of Captured Individuals Outside of a Sensitive Period

- 14.1. Where uninjured individuals are captured under section 13.1, they shall be released:
- (a) within 24 hours of capture;
 - (b) in an area immediately adjacent to the Drainage Works;
 - (c) in an area that will not be further impacted by the undertaking of any Activity; and
 - (d) not more than 250 metres from the capture site.
- 14.2. Following a release under section 14.1, the Municipality shall Contact the MNR within 72 hours of the release to provide information on the name of the Drainage Works, the location of the encounter and the location of the release site.

15. Measures for Dead Turtles

- 15.1. Where one or more individuals of a turtle Species is killed as a result of an Activity in a Work Zone, or if a person undertaking an Activity finds a deceased individual of a turtle Species within the Work Zone, the Municipality shall:
- (a) place any dead turtles in a Holding Tub outside of direct sunlight; and
 - (b) Contact the MNR within 72 hours to seek direction and to arrange for the transfer of the dead individuals.

ADDITIONAL MITIGATION MEASURES FOR SNAKE SPECIES

16. Training and Required On Site Materials for Snakes

- 16.1. The Municipality will ensure any person:
- (a) involved in the capture, temporary holding, transfer and release of any snake Species has received training in proper snake handling procedures; and
 - (b) who undertakes an Activity has a minimum of two Holding Tubs and cotton sacks on site at all times.

17. Activities undertaken in Sensitive Areas and Sensitive Periods for Snakes

- 17.1. Where a proposed Activity involves physical infrastructure (e.g., culverts, pump houses, etc.) and will occur in a Sensitive Area for any snake Species and during a *Sensitive Period – Hibernation* for that Species, the Municipality shall undertake the Activity outside of the Sensitive Period, unless otherwise authorized by and in accordance with any site-specific measures provided in writing by the MNR Designated Representative.
- 17.2. Where a proposed Activity will occur at or adjacent to a known hibernacula (as identified by the MNR) for any snake Species and during a *Sensitive Period – Staging* for that Species, the Municipality shall:
 - (a) erect effective temporary snake barriers approved by the MNR that will not pose a risk of entanglement for snakes and that shall be secured so that individual snakes may not pass over or under the barrier or between any openings to enter or re-enter the Work Zone;
 - (b) inspect the temporary snake barriers daily during periods when snakes are active, capture any individuals incidentally encountered within the area bounded by the snake barrier and release the captured individuals in accordance with section 21.1; and
 - (c) remove the temporary snake barriers immediately upon completion of the Activity.
- 17.3. Where a proposed Activity that does not involve physical infrastructure will occur in a Sensitive Area for any snake Species and during a *Sensitive Period – Staging* for that Species, the Municipality shall undertake the Activity outside of the Sensitive Period, unless otherwise authorized by and in accordance with any site-specific measures provided in writing by the MNR Designated Representative.

18. Measures for Encounters with Snakes During a Sensitive Period

- 18.1. Where one or more individuals belonging to a snake Species is encountered, or should an active hibernacula be uncovered, while conducting an Activity in any part of a Work Zone (including, but not limited to, a Sensitive Area) during a Sensitive Period for that Species, the Municipality shall:
 - (a) capture and transfer all injured and uninjured individual snakes of that Species into individual light-coloured, drawstring cotton sacks;
 - (b) place all cotton sacks filled with the captured individuals into a Holding Tub;
 - (c) ensure that the Holding Tub with the captured individuals is stored at a cool temperature to protect the snakes from freezing until the individuals can be retrieved or transferred;
 - (d) if an active hibernacula is uncovered, cease all Activities at the hibernacula site; and
 - (e) immediately Contact the MNR to seek direction and to arrange for the transfer and/or retrieval.

19. Measures for Encounters with Snake Nests

- 19.1. Where an active nest of any of the snake Species is encountered and disturbed while undertaking an Activity in any part of a Work Zone, the Municipality shall:
 - (a) collect any displaced or damaged eggs and transfer them to a Holding Tub;
 - (b) capture and transfer all injured dispersing juveniles of that Species into a light-coloured drawstring cotton sack;
 - (c) place all cotton sacks with the captured injured individuals into a Holding Tub;

- (d) ensure that the Holding Tub with the captured injured individuals is stored out of direct sunlight;
- (e) immediately Contact the MNR to seek direction and to arrange for the transfer of the injured individuals;
- (f) immediately stop any disturbance to the nest site and loosely cover exposed portions with soil or organic material to protect the integrity of the remaining individuals;
- (g) not drive any equipment over the nest site or conduct any Activities within 5 metres of the nest site;
- (h) not place any dredged materials removed from the Drainage Works on top of the nest site;
- (i) mark out the physical location of the nest site but not by any means that might increase the susceptibility of the nest to predation or poaching; and
- (j) where there are no collected eggs or captured individuals, Contact the MNR within 72 hours to provide information on the location of the nest site.

20. Measures for Encounters with Snakes Outside of a Sensitive Period

- 20.1. Where one or more individuals belonging to a snake Species is encountered while undertaking an Activity in any part of a Work Zone (including, but not limited to, a Sensitive Area) but outside of any Sensitive Period for that Species, the Municipality shall:
- (a) follow the requirements in section 16;
 - (b) briefly stop the Activity for a reasonable period of time to allow any uninjured individual snakes of that Species to leave the Work Zone;
 - (c) if the individuals do not leave the Work Zone after the Activity is briefly stopped in accordance with (b) above, capture all uninjured individuals and release them in accordance with section 21.1;
 - (d) where circumstances do not allow for the immediate release of captured uninjured individuals, they may be transferred into individual, light-coloured, drawstring cotton sacks before placing them in a Holding Tub which shall be stored out of direct sunlight for a maximum of 24 hours before releasing them in accordance with section 21.1;
 - (e) capture and transfer any individuals injured as a result of conducting the Activities into a Holding Tub separate from any Holding Tub containing uninjured individuals; and
 - (f) store all captured injured individuals out of direct sunlight and immediately Contact the MNR to seek direction and to arrange for their transfer.

21. Release of Captured Individuals Outside of a Sensitive Period

- 21.1. Where uninjured individuals are captured under section 20.1, they shall be released:
- (a) within 24 hours of capture;
 - (b) in an area immediately adjacent to the Drainage Works where there is natural vegetation cover;
 - (c) in an area that will not be further impacted by the undertaking of any Activity; and
 - (d) not more than 250 metres from the capture site.

- 21.2. Following a release under section 21.1, the Municipality shall Contact the MNR within 72 hours of the release to provide information on the name of the Drainage Works, the location of the encounter and the location of the release site.

22. Measures for Dead Snakes

- 22.1. Where one or more individuals belonging to a snake Species is killed as a result of an Activity in a Work Zone, or if a person undertaking an Activity finds a deceased individual of a snake Species within the Work Zone, the Municipality shall:
- (a) collect and transfer any dead individuals into a Holding Tub outside of direct sunlight; and
 - (b) Contact the MNR within 72 hours to seek direction and to arrange for the transfer of the carcasses of the dead individuals.

ADDITIONAL MITIGATION MEASURES FOR HERBACEOUS PLANTS

23. Activities Undertaken in Sensitive Areas for Herbaceous Plants

- 23.1. Where a proposed Activity will occur that involves physical disturbance to vegetated banks or the killing and/or removal of vegetation through chemical or mechanical means in a Sensitive Area for any herbaceous plant Species, the Municipality shall:
- (a) undertake the Activity outside of the Sensitive Period, unless otherwise authorized;
 - (b) limit equipment access and operations to the side of the Drainage Works that will minimize disturbances where any of the plant Species occur;
 - (c) locate temporary storage sites for excavated sediments or bank materials on areas of open soil away from where any of the plant Species are likely to occur;
 - (d) not use any broad spectrum herbicides in Sensitive Areas; and
 - (e) undertake Activities in accordance with any additional site-specific measures provided in writing by the MNR Designated Representative.

ADDITIONAL MITIGATION MEASURES FOR TREE SPECIES

24. Additional Measures for Butternut

- 24.1. Where Butternuts may exist in a Work Zone and may be affected by an Activity, the Municipality shall:
- (a) identify and mark as retainable trees all individual Butternut trees within the Work Zone during work planning site visits unless the individual Butternut has been assessed as a non-retainable tree due to infection by Butternut canker by a person designated by the Minister as a Butternut Health Assessor;
 - (b) retain and avoid disturbance to all individuals identified under (a) above that have been identified as retainable trees or that have not been assessed, unless otherwise authorized in writing by the MNR Designated Representative;
 - (c) conduct Activities by:
 - (i) limiting equipment access and operations to the side of the Drainage Works that will minimize disturbance to where any of the individual Butternut trees occur,
 - (ii) working around trees,

- (iii) avoiding compacting and/or disturbing the soil by keeping excavation and other heavy equipment a minimum of 2 metres away from the main stem of retained individuals to avoid damaging roots and stems,
- (iv) placing excavated materials on areas not within 2 metres of the main stem of retained individuals, and
- (v) where branches are required to be removed to allow for safe operation of equipment, removing them using appropriate equipment, such as pruning saws, chain saws or lopping shears, in accordance with good forestry practices.

25. Measures for Other Trees

- 25.1. Where Kentucky Coffee-tree may exist in a Work Zone and may be affected by an Activity, the Municipality shall:
- (a) identify and mark all individual Kentucky Coffee-tree within the Work Zone during work planning site visits;
 - (b) avoid disturbance to all individuals identified under (a) above, unless otherwise authorized in writing by the MNR Designated Representative;
 - (c) conduct Activities by:
 - (i) limiting equipment access and operations to the side of the Drainage Works that will minimize disturbance where any of the individuals occur,
 - (ii) working around trees,
 - (iii) avoiding compacting and/or disturbing the soil by keeping excavation and other heavy equipment a minimum of 2 metres away from the main stem of retained individuals to avoid damaging roots and stems, and
 - (iv) placing excavated materials on areas not within 2 metres of the main stem of retained individuals; and
 - (d) where branches are required to be removed to allow for safe operation of equipment, remove them using appropriate equipment, such as pruning saws, chain saws or lopping shears, in accordance with good forestry practices.

PART D. MONITORING AND REPORTING REQUIREMENTS

26. Compliance Monitoring.

- 26.1. The Municipality shall inspect the undertaking of the Activities at the locations described in Part F of this Schedule C, and shall record the results of the inspections in the Monitoring and Reporting Form.
- 26.2. The Municipality shall record all encounters with Species and the resulting mitigation measures taken by the Municipality in the Monitoring and Reporting Form.

27. Reporting

- 27.1. Prior to March 31 of each year the Mitigation Plan is in effect, the Municipality shall submit a completed Monitoring and Reporting Form containing all of the information collected under sections 26.1 and 26.2 during the previous twelve months to the MNR Designated Representative.

28. Review

- 28.1. Within six months of the expiry of this Mitigation Plan but no later than three months from the time of its expiry, the Parties shall meet to review the measures and actions taken and the Activities undertaken during its term and to discuss the terms and conditions of the next Mitigation Plan.

APPENDIX "REI-C"

STANDARD SPECIFICATIONS FOR ACCESS BRIDGE CONSTRUCTION

1. PRECAST CONCRETE BLOCK & CONCRETE FILLED JUTE BAG HEADWALLS

After the Contractor has set the endwall foundations and the new pipe in place, it shall completely backfill same and install new precast concrete blocks or concrete filled jute bag headwalls at the locations and parameters indicated on the drawing. All concrete used for headwalls shall be a minimum of 30 mPa at 28 days and include 6% +/- 1% air entrainment.

Precast concrete blocks shall be interlocking and have a minimum size of 600mmX600mmX1200mm. Half blocks shall be used to offset vertical joints. Cap blocks shall be a minimum of 300mm thick. A foundation comprising minimum 300mm thick poured concrete or precast blocks the depth of the wall and the full bottom width of the drain plus 450mm embedment into each drain bank shall be provided and placed on a firm foundation as noted below. The Contractor shall provide a levelling course comprising a minimum thickness of 150mm Granular "A" compacted to 100% Standard Proctor Density or 20mm clear stone, or a lean concrete as the base for the foundation. The base shall be constructed level and flat to improve the speed of installation. Equipment shall be provided as required and recommended by the block supplier for placing the blocks such as a swift lift device for the blocks and a 75mm eye bolt to place the concrete caps,. The headwall shall extend a minimum of 150mm below the invert of the access bridge culvert with the top of the headwall set to match the finished driveway grade, unless a 150mm high curb is specified at the edge of the driveway. To achieve the required top elevation, the bottom course of blocks and footing may require additional embedment into the drain bottom. The Contractor shall provide shop drawings of the proposed wall for approval by the Drainage Superintendent or Engineer prior to construction.

Blocks shall be placed so that all vertical joints are staggered. Excavation voids on the ends of each block course shall be backfilled with 20mm clear stone to support the next course of blocks above. Walls that are more than 3 courses in height shall be battered a minimum of 1 unit horizontal for every 5 units of vertical height. The batter shall be achieved by careful grading of the footing and foundation base, or use of pre-battered base course blocks. Filter cloth as specified below shall be placed behind the blocks to prevent the migration of any fill material through the joints. Backfill material shall be granular as specified below. Where the wall height exceeds 1.8 metres in height, a uni-axial geogrid SG350 or equivalent shall be used to tie back the walls and be installed in accordance with the manufacturer's recommendations. The wall face shall not extend beyond the end of the access bridge pipe. Non-shrink grout shall be used to fill any gaps between the blocks and the access bridge pipe for the full depth of the wall. The grout face shall be finished to match the precast concrete block walls as closely as possible.

When constructing the concrete filled jute bag headwalls, the Contractor shall place the bags so that the completed headwall will have a slope inward from the bottom of the pipe to the top of the finished headwall. The slope of the headwall shall be one unit horizontal to five units vertical. The Contractor shall completely backfill behind the new concrete filled jute bag headwalls with Granular "B" and Granular "A" material as per O.P.S.S. Form 1010 and the granular material shall be compacted in place to a Standard Proctor Density of 100%. The placing of the jute bag headwalls and the backfilling shall be performed in lifts simultaneously. The granular backfill shall be placed and compacted in lifts not to exceed 305mm (12") in thickness.

The concrete filled jute bag headwalls shall be constructed by filling jute bags with concrete. All concrete used to fill the jute bags shall have a minimum compressive strength of 25 MPa in 28 days and shall be provided and placed only as a wet mix. Under no circumstance shall the concrete to be used for filling the jute bags be placed as a dry mix. The jute bags, before being filled with concrete, shall have a dimension of 460mm (18") x 660mm (26"). The jute bags shall be filled with concrete so that when they are laid flat, they will be approximately 100mm (4") thick, 305mm (12") to 380mm (15") wide and 460mm (18") long.

The concrete jute bag headwall to be provided at the end of the bridge pipe shall be a single or double bag wall construction as set out in the specifications. The concrete filled bags shall be laid so that the 460mm (18") dimension is parallel with the length of the new pipe. The concrete filled jute bags shall be laid on a footing of plain concrete being 460mm (18") wide, and extending for the full length of the wall, and 305mm (12") thick extending below the bottom of the culvert pipe.

All concrete used for the footing, cap and bags shall have a minimum compressive strength of 30 mPa at 28 days and shall include 6% ± 1% air entrainment.

Upon completion of the jute bag headwall the Contractor shall cap the top row of concrete filled bags with a layer of plain concrete, minimum 100mm (4") thick, and hand trowelled to obtain a pleasing appearance. If the cap is made more than 100mm thick, the Contractor shall provide two (2) continuous 15M reinforcing bars set at mid-depth and equally spaced in

the cap. The Contractor shall fill all voids between the concrete filled jute bags and the corrugated steel pipe with concrete, particular care being taken underneath the pipe haunches to fill all voids.

The completed jute bag headwalls shall be securely embedded into the drain bank a minimum of 450mm (18") measured perpendicular to the sideslopes of the drain.

As an alternate to constructing a concrete filled jute bag headwall, the Contractor may construct a grouted concrete rip rap headwall. The specifications for the installation of a concrete filled jute bag headwall shall be followed with the exception that broken pieces of concrete may be substituted for the jute bags. The concrete rip rap shall be approximately 460mm (18") square and 100mm (4") thick and shall have two (2) flat parallel sides. The concrete rip rap shall be fully mortared in place using a mixture composed of three (3) parts of clean sharp sand and one (1) part of Portland cement.

The complete placement and backfilling of the headwalls shall be performed to the full satisfaction of the Drainage Superintendent and the Engineer.

2. QUARRIED LIMESTONE ENDWALLS

The backfill over the ends of the corrugated steel pipe shall be set on a slope of 1-½ units horizontal to 1 unit vertical from the bottom of the corrugated steel pipe to the top of each end slope and between the drain banks. The top 305mm (12") in thickness of the backfill over the ends of the corrugated steel pipe shall be quarried limestone. The quarried limestone shall also be placed on a slope of 1-½ units horizontal to 1 unit vertical from the bottom of the corrugated steel pipe to the top of each bank of the drain adjacent each end slope. The quarried limestone shall have a minimum dimension of 100mm (4") and a maximum dimension of 250mm (10"). The end slope protection shall be placed with the quarried limestone pieces carefully tamped into place with the use of a shovel bucket so that, when complete, the end protection shall be consistent, uniform, and tightly laid in place.

Prior to placing the quarried limestone end protection over the granular backfill and on the drain banks, the Contractor shall lay non-woven geotextile filter fabric "GMN160" conforming to O.P.S.S. 1860 Class I or approved equal. The geotextile filter fabric shall extend from the bottom of the corrugated steel pipe to the top of each end slope of the bridge and along both banks of the drain to a point opposite the ends of the pipe.

The Contractor shall take extreme care not to damage the geotextile filter fabric when placing the quarried limestone on top of the filter fabric.

3. BRIDGE BACKFILL

After the corrugated steel pipe has been set in place, the Contractor shall backfill the pipe with Granular "B" material, O.P.S.S. Form 1010 with the exception of the top 305mm (12") of the backfill. The top 305mm (12") of the backfill for the full width of the excavated area (between each bank of the drain) and for the top width of the driveway, shall be Granular "A" material, O.P.S.S. Form 1010. The granular backfill shall be compacted in place to a Standard Proctor Density of 100% by means of mechanical compactors. All of the backfill material, equipment used, and method of compacting the backfill material shall be inspected and approved and meet with the full satisfaction of the Drainage Superintendent and Engineer.

4. GENERAL

Prior to the work commencing, the Drainage Superintendent and Engineer must be notified, and under no circumstances shall work begin without one of them being at the site. Furthermore, the grade setting of the pipe must be checked, confirmed, and approved by the Drainage Superintendent or Engineer prior to continuing on with the bridge installation.

The alignment of the new bridge culvert pipe shall be in the centreline of the existing drain, and the placing of same must be performed totally in the dry.

Prior to the installation of the new access bridge culvert, the existing sediment build-up in the drain bottom must be excavated and completely removed. This must be done not only along the drain where the bridge culvert pipe is to be installed, but also for a distance of 3.05 metres (10 ft.) both upstream and downstream of said new access bridge culvert. When setting the new bridge culvert pipe in place it must be founded on a good undisturbed base. If unsound soil is encountered, it must be totally removed and replaced with 20mm (3/4") clear stone, satisfactorily compacted in place.

When doing the excavation work or any other portion of the work relative to the bridge installation, care should be taken not to interfere with, plug up, or damage any existing surface drains, swales, and lateral or main tile ends. Where damage is encountered, repairs to correct same must be performed immediately as part of the work.

The Contractor and/or landowner performing the bridge installation shall satisfy themselves as to the exact location, nature and extent of any existing structure, utility or other object that they may encounter during the course of the work. The Contractor shall indemnify and save harmless the Town, or the Municipality, the Engineer, and their staff from any damages which it may cause or sustain during the progress of the work. It shall not hold them liable for any legal action arising out of any claims brought about by such damage caused by it.

Where applicable, the Contractor and/or landowner constructing the new bridge shall be responsible for any damage caused by them to any portion of the Town road right-of-way. They shall take whatever precautions are necessary to cause a minimum of damage to same and must restore the roadway to its original condition upon completion of the works.

When working along a municipal roadway, the Contractor shall provide all necessary lights, signs, barricades and flagpersons as required to protect the public. All work shall be carried out in accordance with the requirements of the Occupational Health and Safety Act, and latest amendments thereto. If traffic control is required on this project, it is to comply with the M.T.O. Traffic Control Manual for Roadway Work Operations and Ontario Traffic Manual Book 7.

Once the bridge installation has been completed, the drain sideslopes directly adjacent the new headwalls and/or endwalls are to be completely restored including revegetation, where necessary.

All of the work required towards the installation of the bridge shall be performed in a neat and workmanlike manner. The general site shall be restored to its' original condition, and the general area shall be cleaned of all debris and junk, etc. caused by the work

All of the excavation, installation procedures, and parameters as above mentioned are to be carried out and performed to the full satisfaction of the Drainage Superintendent and Engineer.

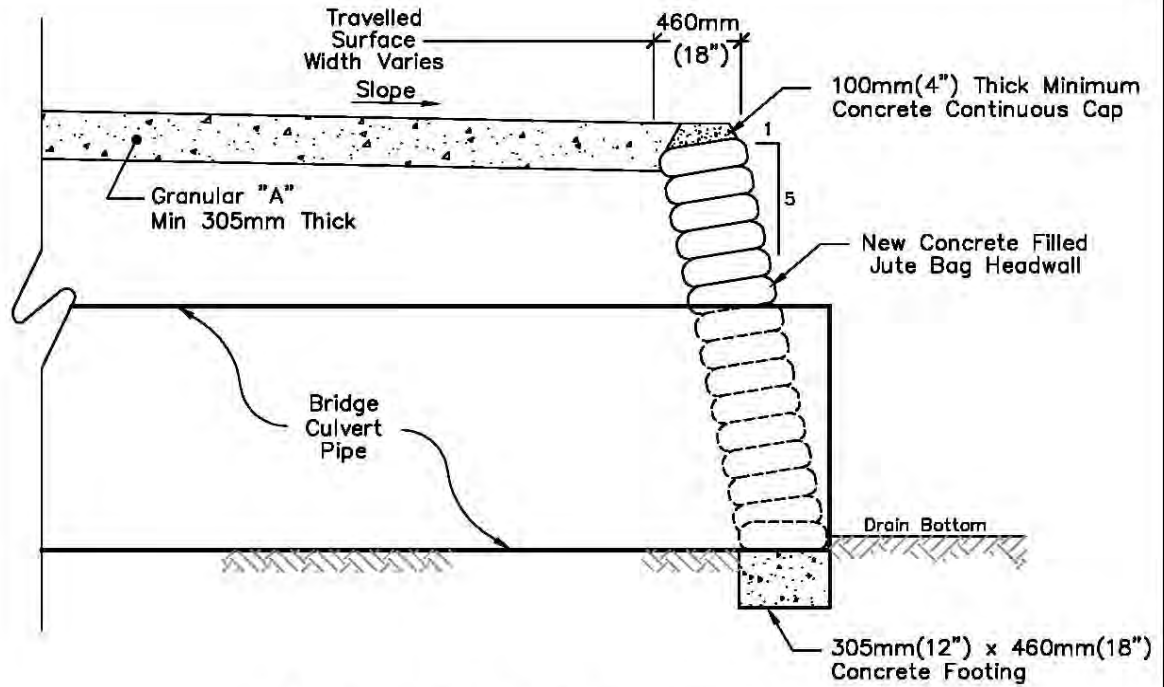

Typical Jute Bag Headwall

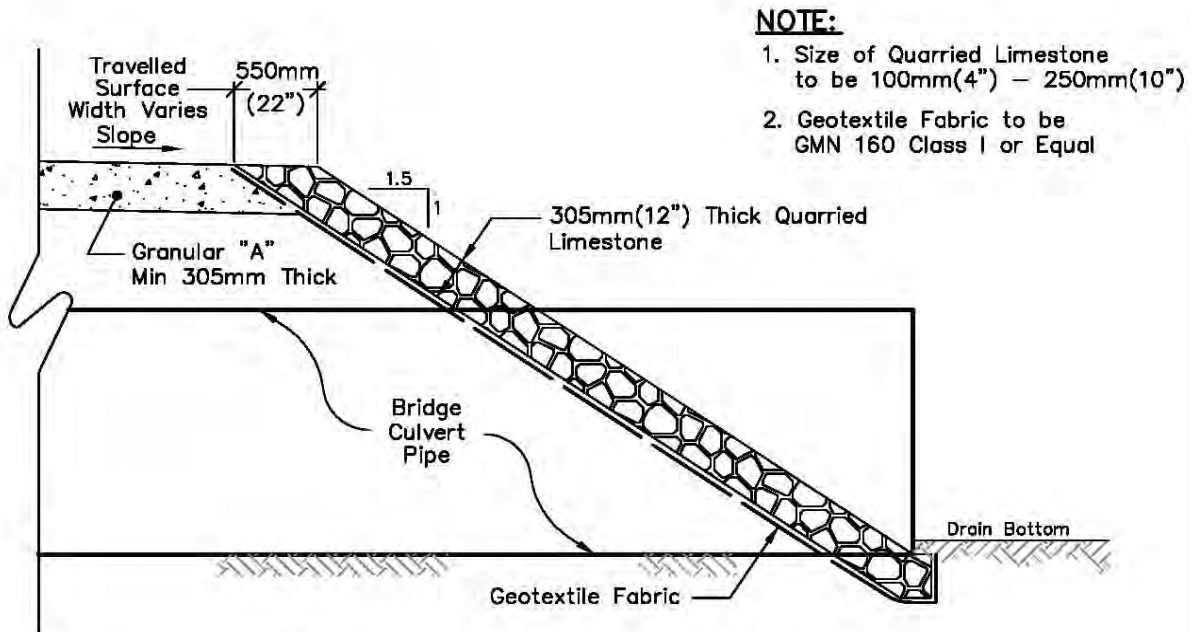

NOTE:

1. Size of Quarried Limestone to be 100mm(4") – 250mm(10")
2. Geotextile Fabric to be GMN 160 Class I or Equal

Typical Quarried Limestone End Protection

Rood Engineering Inc.

Consulting Engineers

9 Nelson Street

Leamington, Ontario N8H 1G6

519-322-1621

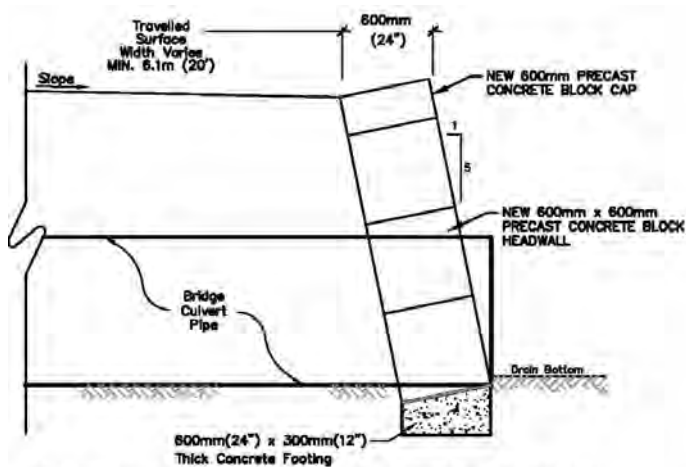
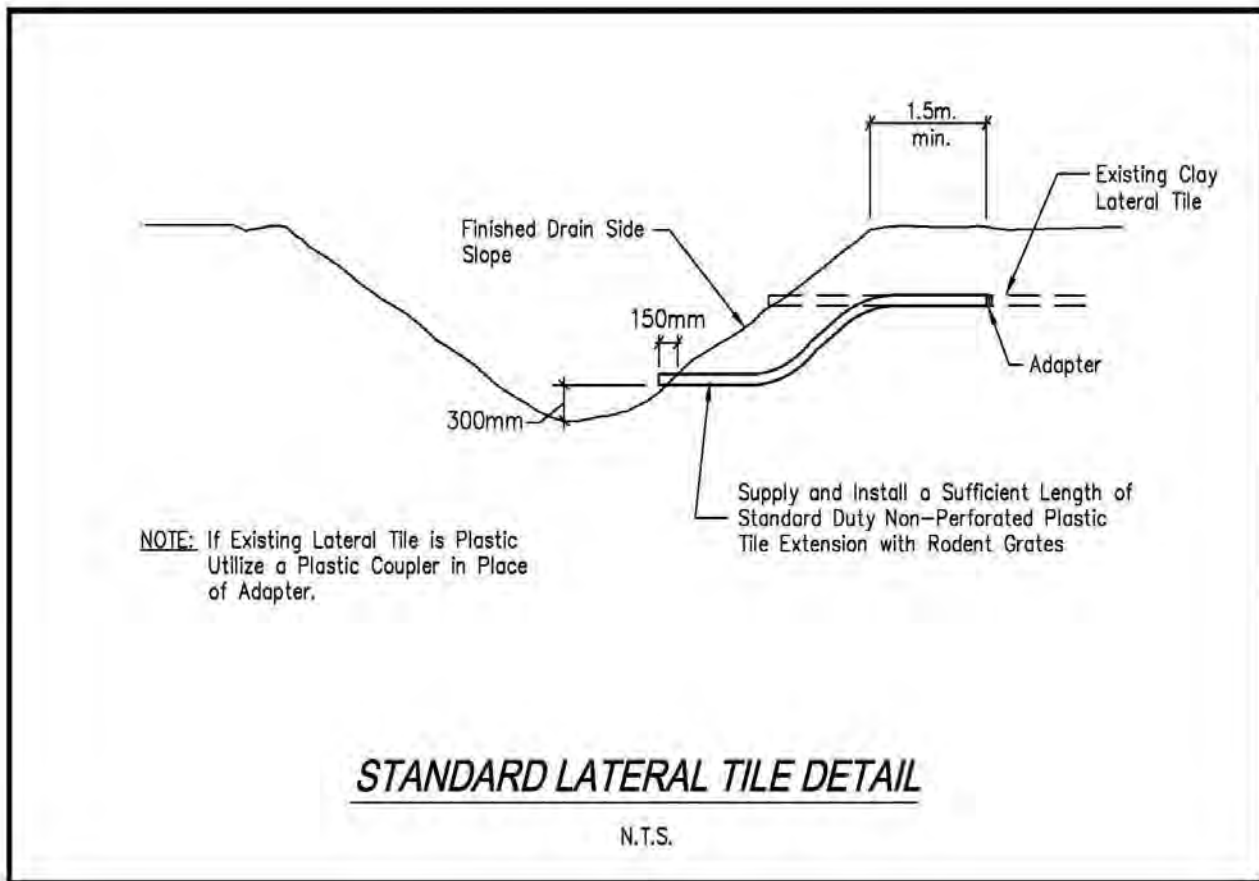

TYPICAL PRECAST CONCRETE BLOCK END PROTECTION
Scale = N.T.S.

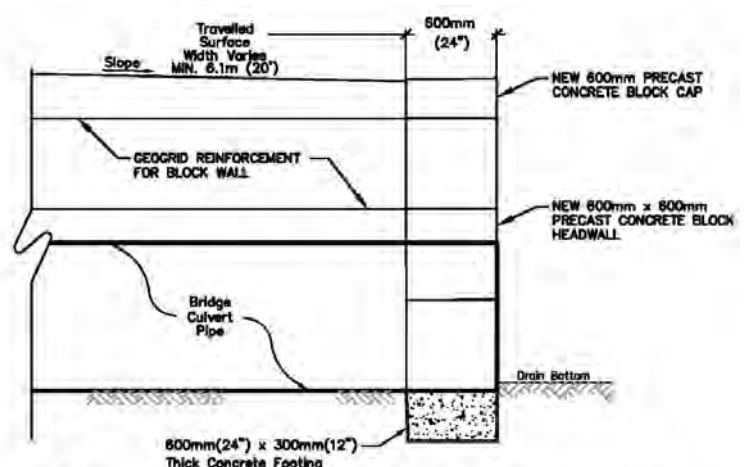

TYPICAL VERTICAL PRECAST CONCRETE BLOCK END PROTECTION
Scale = N.T.S.



Block Headwall Installation Instructions for Culverts

1. A swift lift device will be required to place the blocks. A 75mm eye bolt will be required to place the caps.
2. The bottom course of blocks shall be founded on a firm solid base. The contractor shall provide a minimum levelling course of 150mm of compacted 3/4" Clear Stone, or a 100% compacted granular A, or lean concrete as a foundation base.
3. Ensure that the base is level and flat as this will greatly improve speed of installation.
4. On new culverts a minimum of 150mm of block wall will extend below the culvert to prevent scouring under the culvert.
5. The bottom course of blocks shall be embedded into the drain bottom to achieve the desired top elevation of the wall.
6. Blocks shall extend from the pipe invert across the full height and width of the drain and be imbedded a minimum of 300mm into the drain banks. Where possible the top of the block wall will match the height of the completed driveway.
7. Blocks shall be placed such that all joints are staggered.
8. Any excavation voids on the ends of block walls below subsequent block layers shall be filled with 3/4" Clear Stone.
9. Where block walls extend beyond three blocks in height, they should be battered a minimum of 1 unit horizontal for every 10 units vertical throughout the wall's full height and width. This can be achieved using pre-battered base blocks, or by careful preparation of the base.
10. Filter cloth (270R or equivalent) should be placed behind the wall to prevent the migration of fill material through the joints.
11. The walls should be backfilled with a free draining granular fill.
12. A uni-axial geogrid (SG350 or equivalent) should be used to tie back the headwalls where walls extend beyond 1.8m in height.
13. The face of the block wall shall not extend beyond the end of the pipe culvert.
14. Any gaps between the blocks and culvert shall be sealed with non-shrink grout for the full depth of the block.

APPENDIX "REI-D"

THE CORPORATION OF THE TOWN OF TECUMSEH

BY-LAW NO. 2007-51

Being a by-law to amend By-law No. 2007-41 to regulate the setting of open air fires and identify the precautions and conditions to be observed for such fires within The Corporation of the Town of Tecumseh.

WHEREAS Council considers excessive smoke, smell, airborne sparks or embers to be or could become or cause public nuisances by creating negative health effects on neighbouring residents, increasing fire exposure hazards, infringing the enjoyment of the use of neighbouring properties and generating false or nuisance alarms;

AND WHEREAS Council is empowered under Section 128 of the *Municipal Act* 2001, S.O. 2001, c. 25 as amended, to pass by-laws to prohibit and regulate public nuisances, including matters that, in the opinion of Council are, or could become or cause public nuisances;

AND WHEREAS in accordance with Section 425 of the *Municipal Act* 2001, S.O. 2001, c. 25 as amended, a municipality may pass by-laws providing that a person who contravenes a by-law of the municipality passed under this Act is guilty of an offence;

AND WHEREAS Section 444 of the *Municipal Act* 2001, c. 25 states if a municipality is satisfied that a contravention of a by-law of the municipality passed under this Act has occurred, the municipality may make an order requiring the person who contravened the by-law or who caused or permitted the contravention or the owner or occupier of the land on which the contravention occurred to discontinue the contravening activity;

AND WHEREAS the Council of The Corporation of the Town of Tecumseh enacted By-law No. 2007-41 on the 26th day of June, 2007 to regulate the setting of open air fires and identify the precautions and conditions to be observed for such fires within The Corporation of the Town of Tecumseh;

AND WHEREAS the Council of The Corporation of the Town of Tecumseh is desirous of amending By-law No. 2007-41;

NOW THEREFORE THE COUNCIL OF THE CORPORATION OF THE TOWN OF TECUMSEH ENACTS AS FOLLOWS:

1. **That** paragraph 4.9 be deleted and replaced with the following paragraph:
 - 4.9 Permitted fires, except those described in Section 4.4, shall,
 - a) be kept to manageable size that shall not be greater than one (1) square metre with flames no higher than one (1) metre in height; and,
 - b) in residentially zoned areas, be completely extinguished by 2:00 a.m.
2. **That** paragraph 5.2 be deleted and replaced with the following paragraph:
 - 5.2 An application for a Permit must be completed on the form/forms provided by the Tecumseh Fire/Rescue Services.

3. **That** paragraph 5.3 be deleted and replaced with the following paragraph:

5.3 An application must be filed with the Chief Fire Official of the Tecumseh Fire/Rescue Services. Approved permits must be retained and presented to an attending fire official in the event that there is a need for a fire official to attend at the burn location due to complaint.

4. **That** this by-law shall take full force and effect on the third and final reading.

READ a first, second, third time and finally passed this 11th day of September, 2007.



Gary McNamara, Mayor

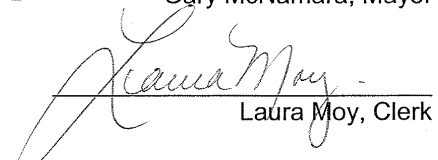

Laura Moy, Clerk

THE CORPORATION OF THE TOWN OF TECUMSEH

BY-LAW NUMBER 2007-41

A by-law to regulate the setting of open air fires and identify the precautions and conditions to be observed for such fires within The Corporation of the Town of Tecumseh.

WHEREAS Council considers excessive smoke, smell, airborne sparks or embers to be or could become or cause public nuisances by creating negative health effects on neighbouring residents, increasing fire exposure hazards, infringing on the enjoyment of the use of neighbouring properties and generating false or nuisance alarms;

AND WHEREAS Council is empowered under Section 128 of the *Municipal Act 2001*, S.O. 2001, c. 25 as amended, to pass bylaws to prohibit and regulate public nuisances, including matters that, in the opinion of Council are, or could become or cause public nuisances;

AND WHEREAS in accordance with Section 425 of the *Municipal Act 2001*, S.O. 2001, c. 25 as amended, a municipality may pass by-laws providing that a person who contravenes a by-law of the municipality passed under this Act is guilty of an offence;

AND WHEREAS Section 444 of the *Municipal Act 2001* c. 25 states if a municipality is satisfied that a contravention of a by-law of the municipality passed under this Act has occurred, the municipality may make an order requiring the person who contravened the by-law or who caused or permitted the contravention or the owner or occupier of the land on which the contravention occurred to discontinue the contravening activity;

AND WHEREAS Section 446(1) of the *Municipal Act 2001* c.25 states that if a municipality has the authority under this or any other Act or under a by-law under this or any other Act to direct or require a person to do a matter or thing, the municipality may:

- provide that, in default of it being done by the person directed or required to do it, the matter or thing shall be done at the person's expense;
- enter upon land at any reasonable time;
- recover the costs of doing a matter or thing from the person directed or required to do it by action or by adding the costs to the tax roll and collecting them in the same manner as property taxes; and
- that costs include interest calculated at a rate of 15 per cent or such lesser rate as may be determined by the municipality, calculated for the period commencing on the day the municipality incurs the costs;
- the costs, including interest, constitutes a lien on the land upon the registration in the proper land registry office of a notice of lien;

AND WHEREAS Section 390 of the *Municipal Act 2001* c.25 provides that a "person" includes a municipality and a local board and the Crown;

AND WHEREAS Section 426 of the *Municipal Act 2001* c. 25 provides that no person shall hinder or obstruct, or attempt to hinder or obstruct any person exercising a power or performing a duty under this Act or a by-law under this Act and that any person who contravenes subsection (1) is guilty of an offence;

NOW THEREFORE THE COUNCIL OF THE CORPORATION OF THE TOWN OF TECUMSEH ENACTS AS FOLLOWS:

1. DEFINITIONS

In this By-law:

- 1.1 "Burning Appliance" means any device designed or engineered to have a fire set within a contained area and totally enclosed by various means of screening and/or other methods.
- 1.2 "By-law Enforcement Officer" means the municipal person appointed by the Town of Tecumseh who shall be responsible for the enforcement of the provisions of this by-law.
- 1.3 "Chief Fire Official" means the Fire Chief of the Tecumseh Fire/ Rescue Services or designate.
- 1.4 "Competent Adult" means any person (18 years of age or older) who, in the opinion of those charged with enforcement of this By-Law, is capable of exercising the required judgement and capable of performing the necessary actions to control and prevent its unwanted spread.
- 1.5 "Farmer" means the owner or operator of an agricultural operation within an area zoned for agricultural pursuant to the *Farming & Food Protection Act*, 1998.
- 1.6 "Farmlands" means land designated "agricultural".
- 1.7 "Firefighter" means any person or any rank of person employed in, or appointed to the Tecumseh Fire/Rescue Services and assigned to undertake fire protection or fire prevention services.
- 1.8 "Full Cost Recovery Basis" has the meaning as described in Schedule "A" attached hereto.
- 1.9 "Open Air" means any open place, yard, field, lot, part lot or construction area which is not enclosed by a building or structure.
- 1.10 "Open Air Burning" means any fire set in the Open Air.
- 1.11 "Owner" means the registered owner or any person, firm or corporation having control over, or possession, of any portion of the building or property under consideration and includes the persons in the building or on the property.
- 1.12 "Permit" means a permit issued by the Chief Fire Official to set a fire in the Open Air for a specified date and period of time.
- 1.13 "Person" means an individual, business, a partnership or a corporation.
- 1.14 "Pit" means an area dug into the ground and/or surrounded by materials designed to contain the fire and prevent its spread to areas beyond the Pit.
- 1.15 "Police Officer" means any member of the Ontario Provincial Police.
- 1.16 "Tenant" means the occupant having possession or Person having control of a property or premises.
- 1.17 "Town" means The Corporation of the Town of Tecumseh.

2. ADMINISTRATION AND ENFORCEMENT

- 2.1 The Chief Fire Official shall be responsible for the administration of this by-law.
- 2.2 Enforcement of this by-law is the responsibility of the Chief Fire Official, any Fire-fighter, any Police Officer or any By-law Enforcement Officer.
- 2.3 The Chief Fire Official may refuse to issue a Permit or revoke any or all issued Permits.
- 2.4 The Fire Chief, Firefighters or Police Officers may, at all times enter and inspect any property or premises in order to ascertain whether the provisions of this by-law are complied with and to enforce or carry into effect the by-law.
- 2.5 Any person who fails to comply with the provisions of this by-law or fails to extinguish a fire once notification to do so has been given to him by the Chief Fire Official, a Police Officer or a Firefighter shall, in addition to any penalty provided herein, be liable to the municipality for all expenses incurred for the purposes of controlling and extinguishing of any fire so set or left to burn and such expenses may be recovered by court action or in a like manner as municipal taxes.

3. ENVIRONMENT

- 3.1 All Open Air Burning shall comply with the provisions of the *Environmental Protection Act*, R.S.O. 1990. c. E19.
- 3.2 No Open Air Burning shall be permitted when a smog alert has been issued for the region of Essex County, which includes the Town.
- 3.3 No Open Fire shall be started or maintained when wind condition is in such direction or intensity so as to cause any or all of the following:
 - (a) decrease in visibility on any highway or roadway;
 - (b) threaten a rapid spread of fire through a grass or brush area;
 - (c) smoke which causes annoyance or irritation to adjacent persons, properties or premises.

4. GENERAL PROVISIONS

- 4.1 No Person being the Owner or Tenant in possession of lands within the Town shall allow a fire to be set or burn on such lands unless a Permit has been obtained.
- 4.2 No Person shall allow a fire to be set or burned exceeding the requirements of Sections 4.8 and 4.9.
- 4.3 Notwithstanding any provisions herein, no Person shall set or maintain a fire,
 - (a) in contravention of the *Ontario Fire Code*, the *Environmental Protection Act* or any other statutory requirements of the Province of Ontario or the Government of Canada;
 - (b) where the consumption of material or size and area of the fire will exceed the limits set by the Chief Fire Official and/or listed within this by-law in Sections 4.8 and 4.9.

- 4.4 (a) No Permit shall be required for domestic barbeques or permanent outdoor fireplaces used solely for the cooking of food on a grill and extinguished immediately upon completion of the cooking process or any Burning Appliance, or a Pit or open area where the requirements of Sections 4.8 and 4.9 are not exceeded;
- (b) installation and location of Burning Appliances must meet the manufacturer's specifications.
- 4.5 (a) A farmer who intends to set or maintain a fire in the Open Air on a specified day for disposal of vegetable matter or vegetation on Farmlands which is normal and incidental for farming purposes shall obtain a Permit to cover the period of the proposed Open Air fire, and will be required to notify the Tecumseh Fire/Rescue Services for each day that the proposed Open Air fire will take place;
- (b) an Open Air fire shall be supervised by a Competent Adult equipped with sufficient equipment to control and contain the Open Air fire to prevent the spread of the Open Air fire that would endanger or put at risk other properties or premises;
- (c) an Open Air fire shall be restricted to daylight hours only;
- (d) an Open Air fire shall be surrounded by a tilled area wide enough to prevent an Open Air fire from jumping across the tilled area and to maintain the area of the burn to be no greater than one (1) hectare in size;
- (e) the leading edge of the flame of an Open Air fire shall not exceed thirty (30) metres in length.
- 4.6 No Person shall set any fire in the Open Air to burn asphalt products, tires, treated wood, construction materials or rubble, kitchen garbage or any garbage or trash, rubber plastics and like items.
- 4.7 No Person shall set any fire in the Open Air except where permitted and only in the presence of a Competent Adult. The Competent Adult shall not leave the burning operation until such time as the fire has been completely extinguished and there is no threat of re-ignition or spreading of the fire.
- 4.8 Every Person that starts a fire in the Open Air shall ensure that there are adequate tools and/or water on hand to contain or extinguish the fire.
- 4.9 Permitted fires, except those described in Section 4.4, shall be kept to manageable size that shall not be greater than one (1) square metre with flames no higher than one (1) metre in height.
- 4.10 Every Person who sets an Open Air fire in the Town of Tecumseh shall be:
- (a) responsible and liable for any damage to property or injury to person occasioned by said fire;
- (b) liable for all costs incurred by the Town of Tecumseh, including but not limited to, the Fire/Rescue Services, including personnel and other agencies called to control and extinguish said fire on a Full Cost Recovery Basis. All fees and charges to be paid under this subsection shall be payable in the manner and subject any interest and penalties set forth in paragraph 5 and 6 of the Administrative Fees and Charges By-law 2007-12, as may be amended or repealed from time to time;

(c) the fees and charges under this section shall not be payable by that class of persons which have obtained a permit for an Open Air fire and complied with the terms of such permit.

- 4.11 Notwithstanding the aforementioned sections listed herein, the Fire Chief may issue a Permit upon application and approve the setting of any fire subject to the fire being adequately supervised and controlled through special conditions addressed by the Chief Fire Official.
- 4.12 No fire shall be set to dispose of commercial, industrial or construction waste or other like materials in areas zoned for commercial or industrial occupancies and such aforementioned materials shall not be transported to residential or agricultural areas for burning purposes.
- 4.13 No fires shall be set at construction and/or demolition sites for the purpose of disposing of waste, building material or rubble.

5. FIRES REQUIRING PERMITS

- 5.1 Except as provided in section 4.3 of this by-law, no Person shall set, maintain or cause to be set or maintained, a fire in the Open Air unless a Permit has been issued by the Chief Fire Official.
- 5.2 An application for a Permit must be completed on the form/forms provided by the Tecumseh Fire/Rescue Services. Such forms are available to fill out by telephone call to Tecumseh Fire Station No. 1, Monday to Friday from 08:30 hr to 16:30 hr.
- 5.3 Each completed application for a Permit must be filed with the Chief Fire Official of the Tecumseh Fire/Rescue Services, at the administration offices located at 985 Lesperance Road, Tecumseh, Ontario.
- 5.4 In issuing a Permit under this part for Open Air Burning, the Chief Fire Official may impose any additional requirements or conditions as may be deemed necessary.

6. OFFENCES

- 6.1 (a) Any person who contravenes any of the provisions of this by-law is guilty of an Offence;
- (b) any person who hinders or obstructs a person lawfully carrying out the enforcement of this by-law is guilty of an Offence.

7. FINES

- 7.1 Every Person who is convicted of an Offence is liable to a Fine of not more than Five Thousand (\$5,000.00) Dollars as provided for in the *Provincial Offences Act*, R. S.O. 1990, Chap. P.33.

8. SEVERABILITY

- 8.1 If any section or sections of this by-law or parts thereof are found in any court to be illegal or beyond the power of Council to enact, such section or sections or parts thereof shall be deemed severable and all other sections or parts of this by-law shall be deemed separate and independent there from and enacted as such.

9. **SHORT TITLE**

9.1 The short title of this by-law shall be TECUMSEH OPEN AIR BURNING BY-LAW.

10. **EFFECTIVE DATE**

10.1 This by-law shall come into full force and take effect on the 1st day of July, 2007.

11. **REPEAL**

11.1 By-law No. 2005-57 is hereby repealed.

READ a first, second, third time and finally passed this 26th day of June, 2007.

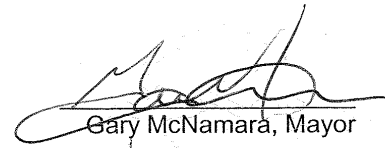

Gary McNamara, Mayor

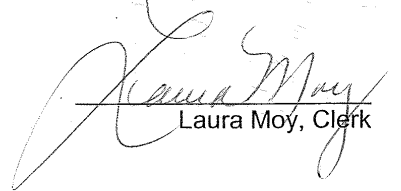

Laura Moy, Clerk

SCHEDULE "A"
By-law Number 2007-41

**THE CORPORATION OF THE TOWN OF TECUMSEH
TECUMSEH FIRE/RESCUE SERVICES EQUIPMENT SERVICES RATES**

"Full Cost Recovery Basis" includes any and all charges and costs howsoever incurred by the Town directly or indirectly in controlling and extinguishing the Open Air fire and shall include without limitations:

Emergency Services Rendered:

- (a) \$350.00 first hour or part thereof per piece of equipment;
- (b) \$175.00 each additional half-hour or part thereof per piece of equipment;
- (c) \$42.00 first hour or part thereof per firefighter who responds to the call;
- (d) \$27.50 for each additional hour or part thereof per firefighter until all equipment is cleaned, checked and returned to service;
- (e) the cost of all extinguishing agents required to extinguish the fire.

No Emergency Services Rendered:

- (a) \$350.00 flat rate per piece of equipment where services are not required nor provided;
- (b) \$42.00 flat rate per firefighter who responds to the call for service.

APPENDIX "REI-E"

WATERSHED PLAN
OF THE
SHUTTLEWORTH DRAIN
New & Replacement Bridges, Enclosures & Maintenance

IN THE
(Geographic Township of Sandwich South)
IN THE
TOWN OF TECUMSEH
IN THE
COUNTY OF ESSEX • ONTARIO

Gerard Rood
GERARD ROOD, P.ENG.



ROOD ENGINEERING INC.
CONSULTING ENGINEERS
Leamington, Ontario
519-322-1621

DATE: Reconsidered August 21st, 2023

TOWN OF TECUMSEH
MAYOR: Gary McNamara
CLERK: Laura Moy
DRAINAGE SUPERINTENDENT: Alessia Mussio

BENCHMARKS:

- 1) TOP NUT OF HYDRANT LOCATED APPROX. 17.5 METRES EAST OF THE EAST END OF PROPOSED BRIDGE FRONTING MN 5074 ON THE NORTH SIDE OF NORTH TALBOT ROAD
ELEV: 188.722m
- 2) TOP NUT OF FH ON NORTH SIDE OF NORTH TALBOT ROAD DIRECTLY IN FRONT OF MN.5410
ELEV: 188.632m
- 3) TOP NUT OF FH ON NORTH SIDE OF NORTH TALBOT ROAD ACROSS THE ROAD OF MN.5475 AND IN FRONT OF MN.5480
ELEV: 188.673m

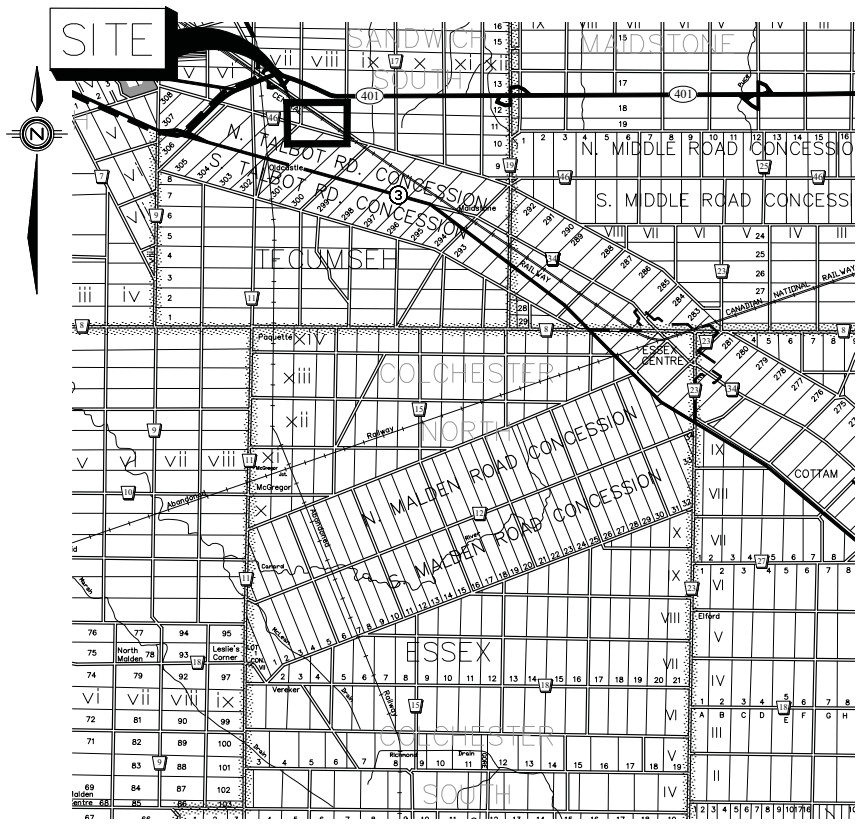

KEY PLAN
Scale = 1:100,000

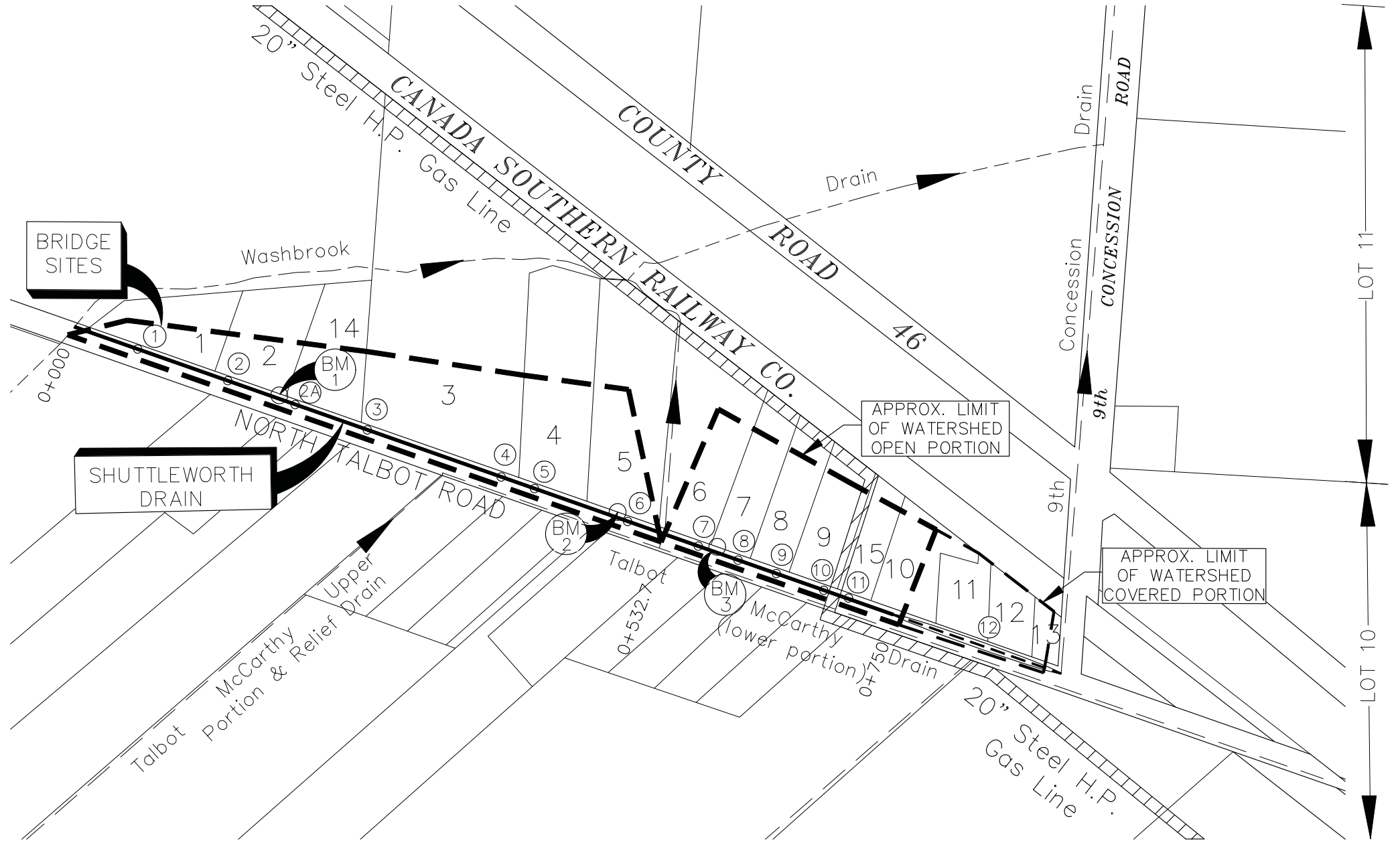
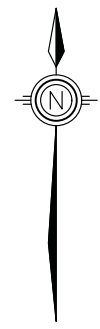

SHUTTLEWORTH DRAIN WATERSHED PLAN
Scale = 1:2,000

- | | | | |
|---|---|---|--|
| 1. Fabio Pace & Giselle Rossi
(540-00800), MN 4976 | 5. Robert & Peggy Weston
(540-00500), MN 5410 | 9. Adam & Vittoria Fortier
(540-00320), MN 5520 | 13. Mark Shafer
(540-00100), MN 5790 |
| 2. Gary & Linda Deneau
(540-00701), MN 5074 | 6. Amelia Conciatori
(540-00400), MN 5466 | 10. John White
(540-00301), MN 5648 | 14. Linda Deneau
(540-00703), MN 5078 |
| 3. Town of Tecumseh
(540-00700), MN 5284 | 7. Emile & Marisa Nabbout
(540-00360), MN 5480 | 11. Ian Bristow
(540-00300), MN 5700 | 15. Timothy Kuhn & Sandra Vasquez
(540-00303 Severance), MN 56360 |
| 4. Theresa Gates
(540-00600), MN 5330 | 8. Ronnie & Rosa Dowhan
(540-00340), MN 5500 | 12. Thomas & Debra McGuinness
(540-00200), MN 5760 | |

NOTE:
PIPE 12 IS AN ENCLOSURE THAT INCLUDES PRIMARY ACCESSES TO THE ADJUTING PARCELS
PARCEL 6 BRIDGE 7 WILL HAVE REPLACEMENT ENCLOSURE AND CATCH BASIN

THESE PLANS HAVE BEEN REDUCED AND THE SCALE THEREFORE VARIES. FULL SCALE PLANS MAY BE VIEWED AT THE MUNICIPAL OFFICE.

DRAWN BY: K.D.
PLOT CODE: 1:1
COMPUTER FILE: REI2017D020.DWG
FILE No.: REI2017D020 SHEET No.: 1 OF 9

PROFILE AND SECTIONS

OF THE

SHUTTLEWORTH DRAIN

New & Replacement Bridges, Enclosures & Maintenance
(Geographic Township of Sandwich South)

IN THE

TOWN OF TECUMSEH

IN THE

COUNTY OF ESSEX • ONTARIO

BENCHMARKS:

- 1) TOP NUT OF HYDRANT LOCATED APPROX. 17.5 METRES EAST OF THE EAST END OF PROPOSED BRIDGE FRONTING MN 5074 ON THE NORTH SIDE OF NORTH TALBOT ROAD
ELEV: 188.722m
- 2) TOP NUT OF FH ON NORTH SIDE OF NORTH TALBOT ROAD DIRECTLY IN FRONT OF MN.5410
ELEV: 188.632m
- 3) TOP NUT OF FH ON NORTH SIDE OF NORTH TALBOT ROAD ACROSS THE ROAD OF MN.5475 AND IN FRONT OF MN.5480
ELEV: 188.673m

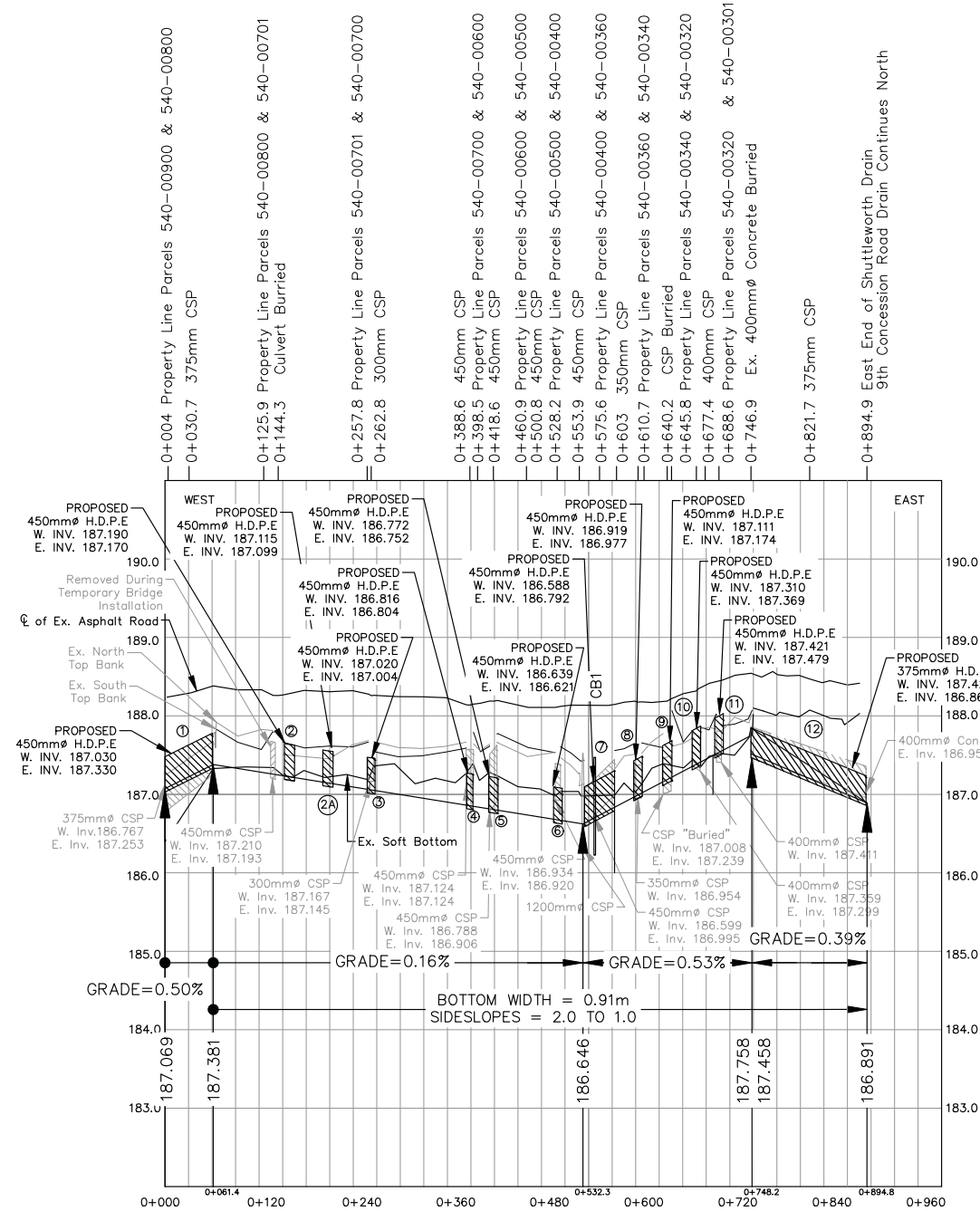

PROFILE - SHUTTLEWORTH DRAIN

SCALE=1:5000 hor.
1:50 vert.

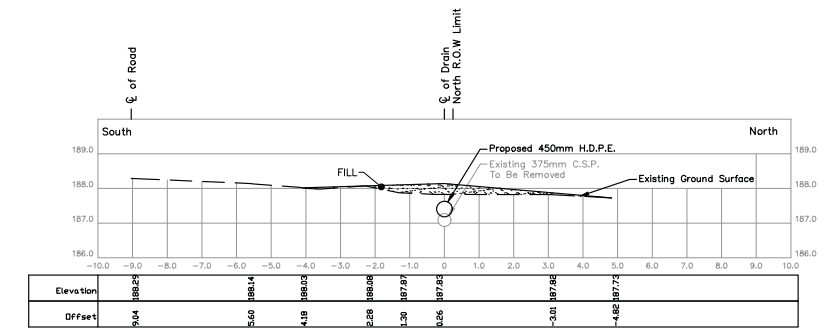

STA. 0+030
Scale = 1:100

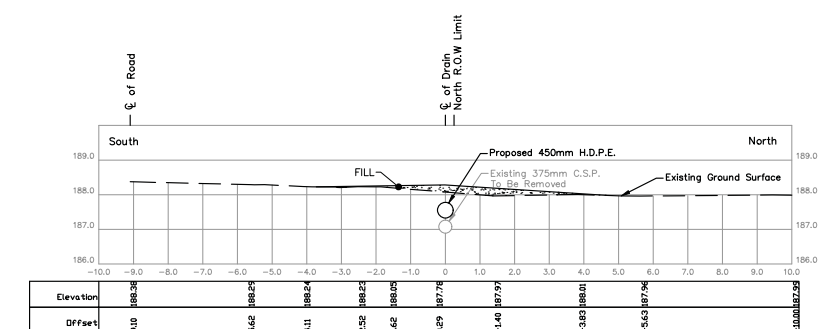

STA. 0+060
Scale = 1:100

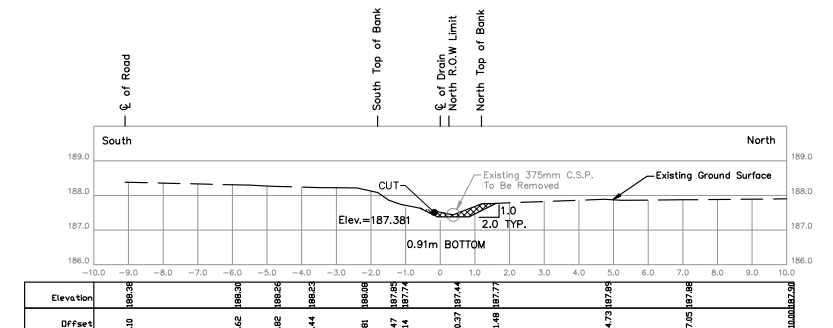

STA. 0+061.4
Scale = 1:100

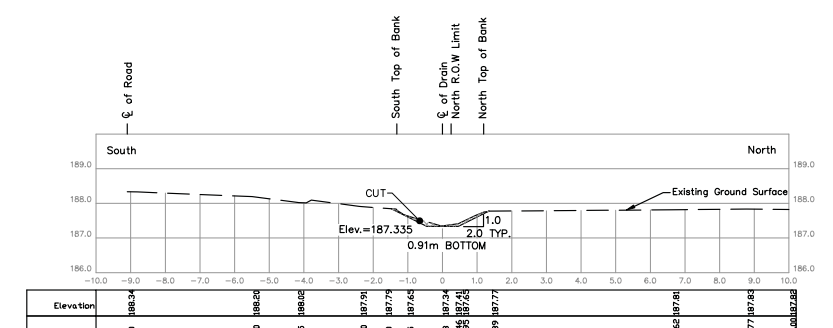

STA. 0+090
Scale = 1:100

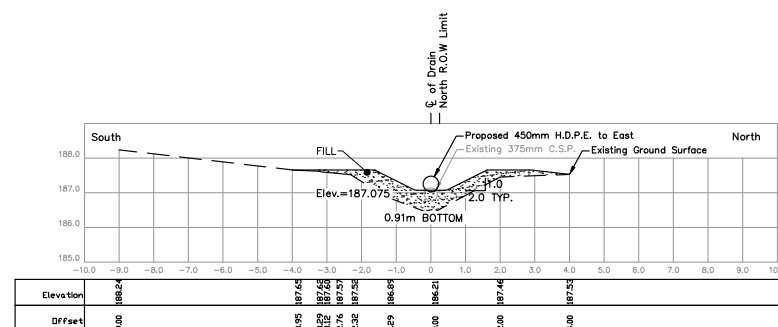

STA. 0+000
Scale = 1:100

THESE PLANS HAVE BEEN REDUCED AND THE SCALE THEREFORE VARIES. FULL SCALE PLANS MAY BE VIEWED AT THE MUNICIPAL OFFICE.

DRAWN BY: L.V. & K.D.
PLOT CODE: 1:1
COMPUTER FILE: REI2017D020.DWG

FILE No.: REI2017D020 SHEET No.: 2 OF 9

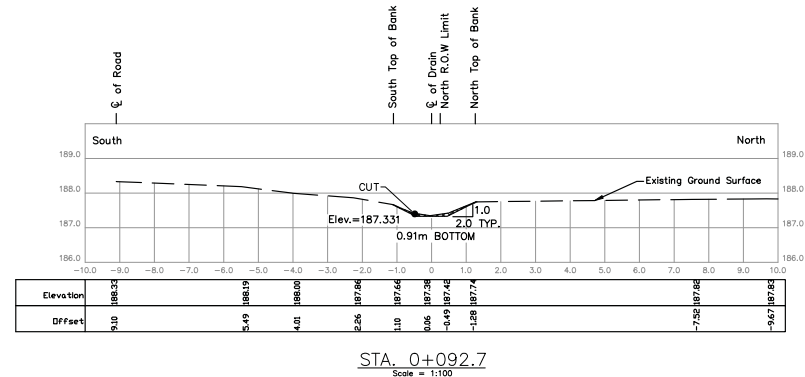

STA. 0+092.7
Scale = 1:100

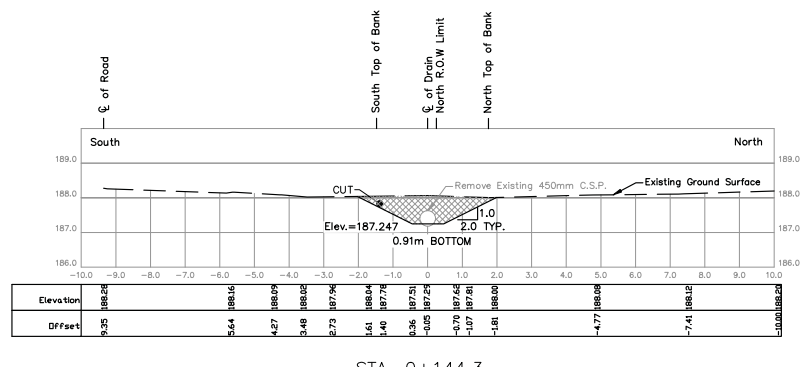

STA. 0+144.3
Scale = 1:100

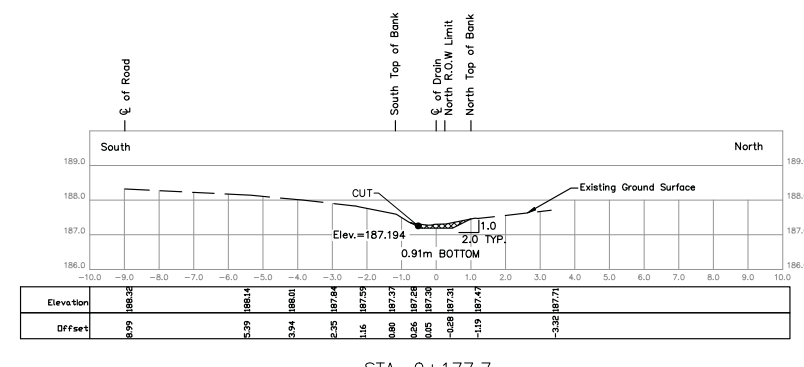

STA. 0+177.7
Scale = 1:100

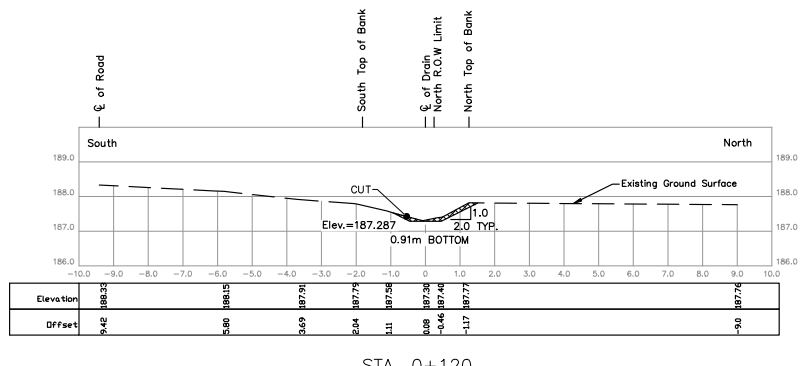

STA. 0+120
Scale = 1:100

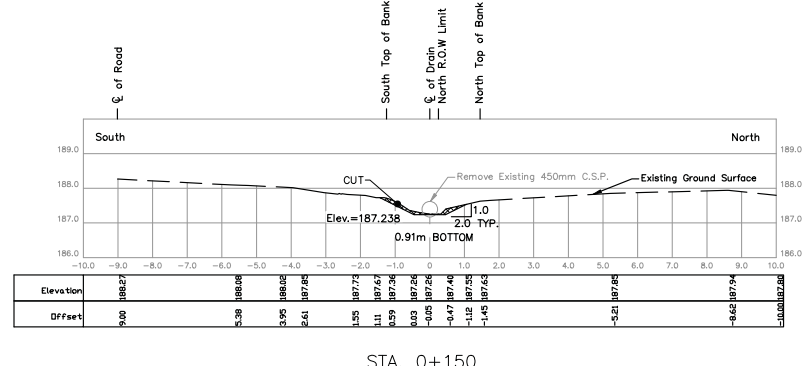

STA. 0+150
Scale = 1:100

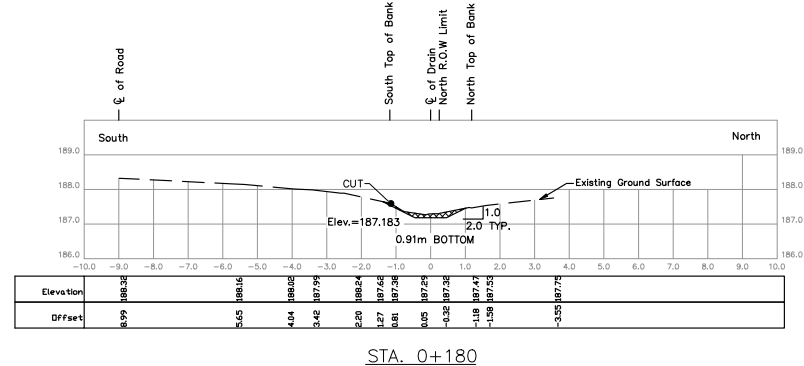

STA. 0+180
Scale = 1:100

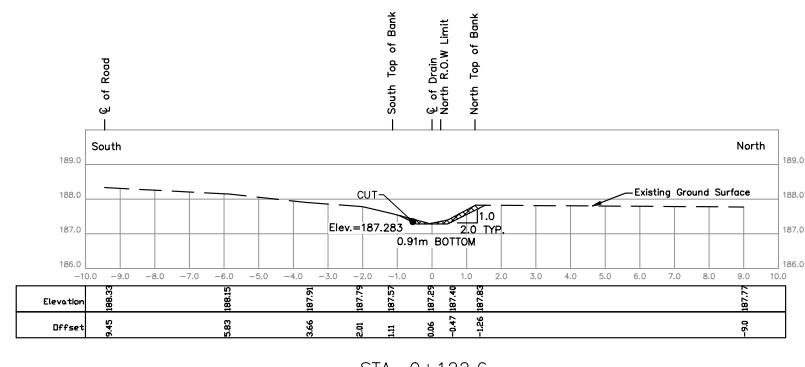

STA. 0+122.6
Scale = 1:100

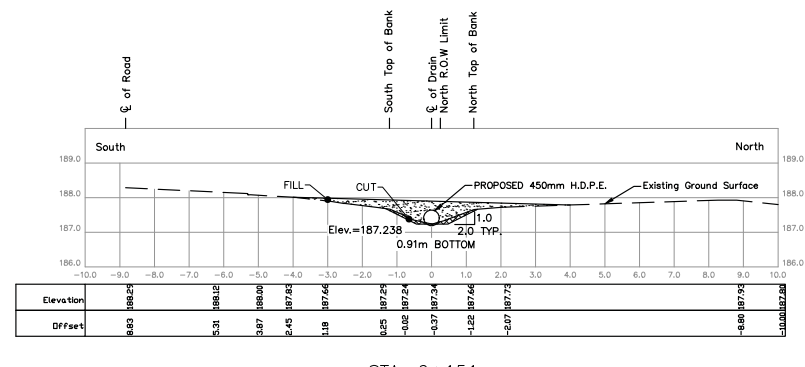

STA. 0+151
Scale = 1:100

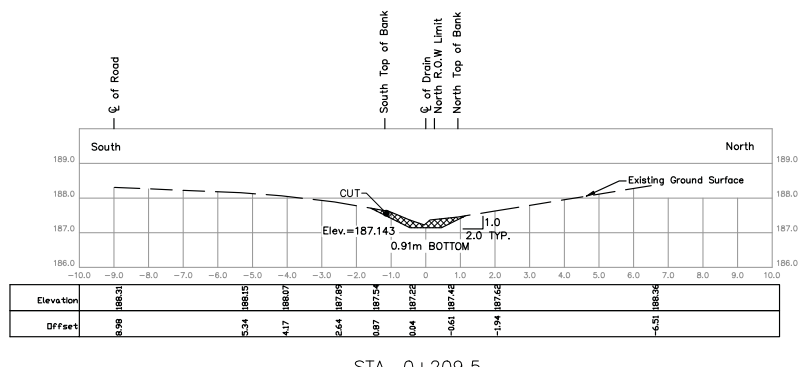

STA. 0+209.5
Scale = 1:100

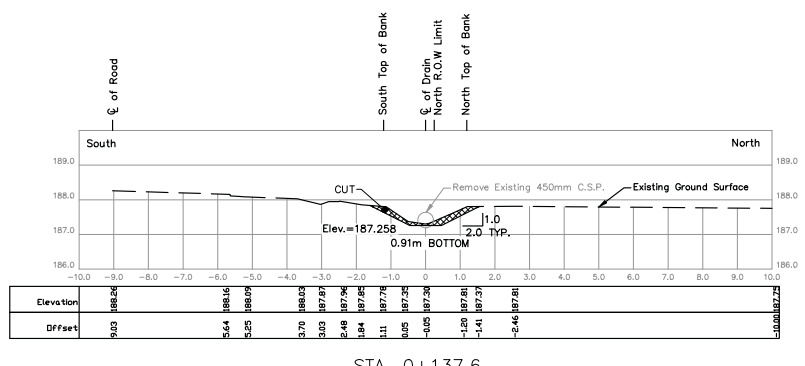

STA. 0+137.6
Scale = 1:100

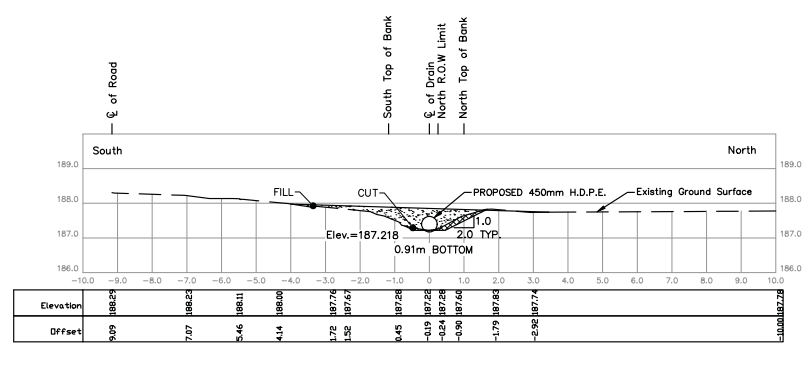

STA. 0+162.8
Scale = 1:100

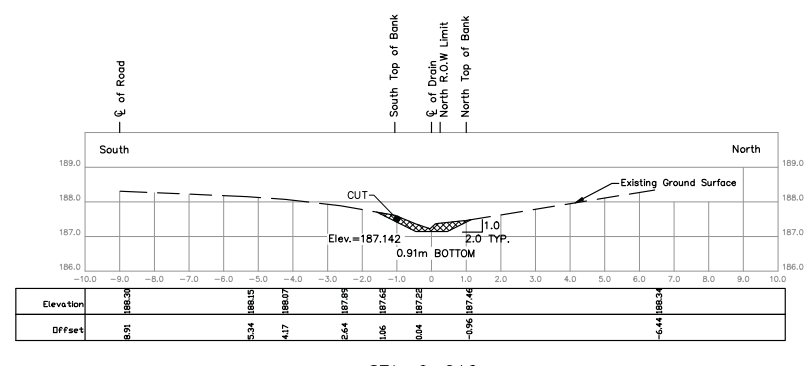

STA. 0+210
Scale = 1:100

THESE PLANS HAVE BEEN REDUCED AND THE SCALE THEREFORE VARIES. FULL SCALE PLANS MAY BE VIEWED AT THE MUNICIPAL OFFICE.

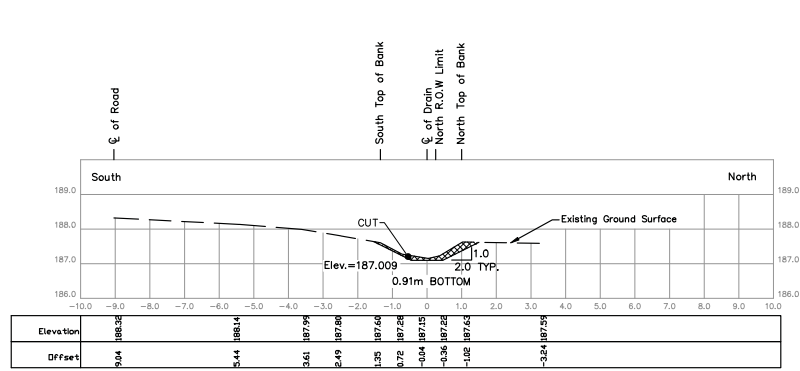

STA. 0+238.7
Scale = 1:100

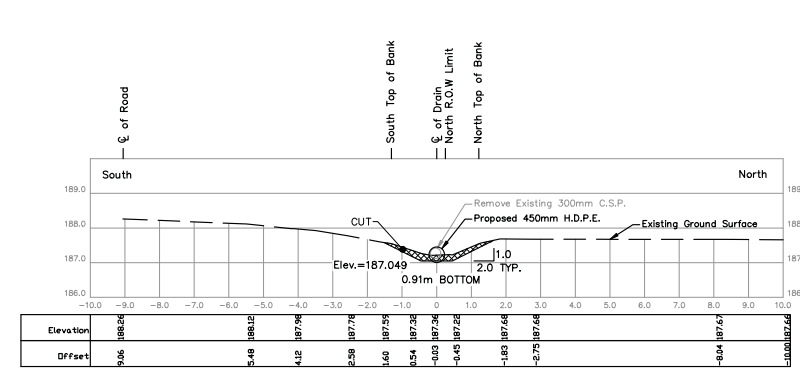

STA. 0+266.3
Scale = 1:100

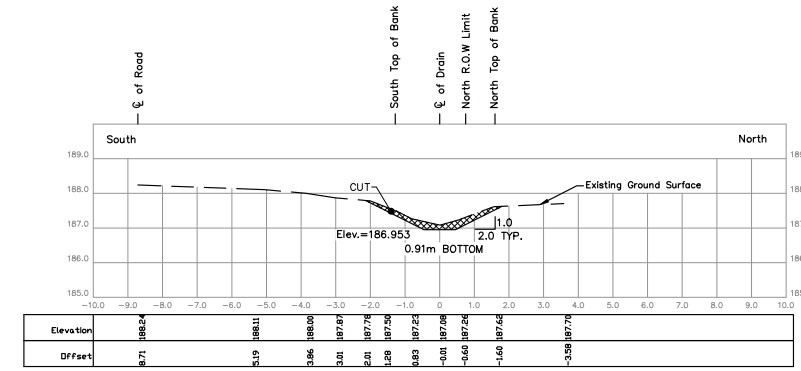

STA. 0+327.5
Scale = 1:100

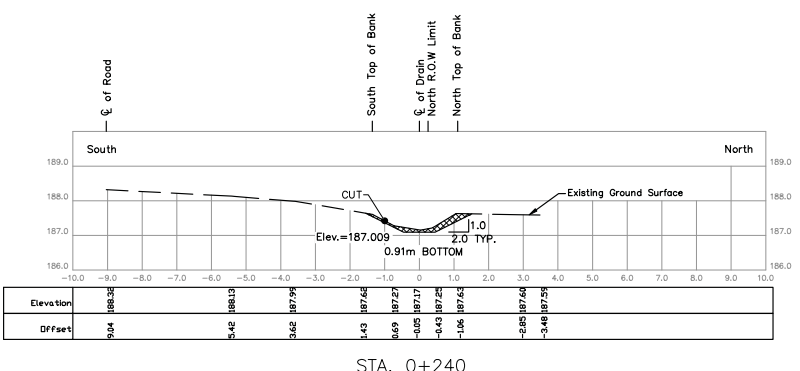

STA. 0+240
Scale = 1:100

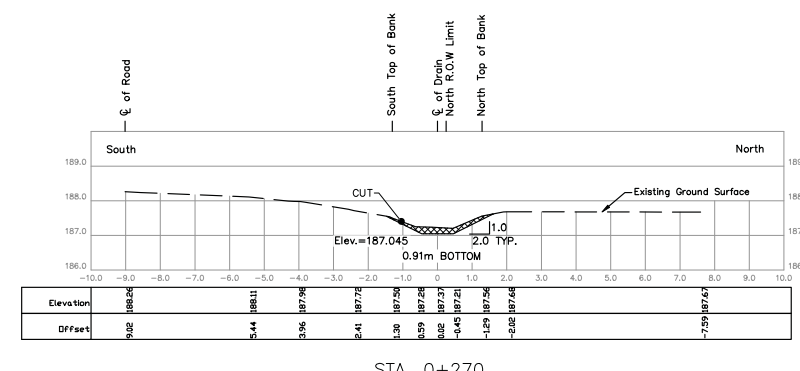

STA. 0+270
Scale = 1:100

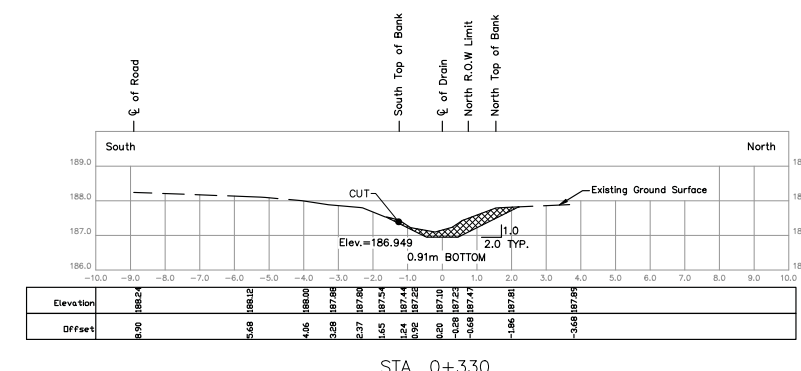

STA. 0+330
Scale = 1:100

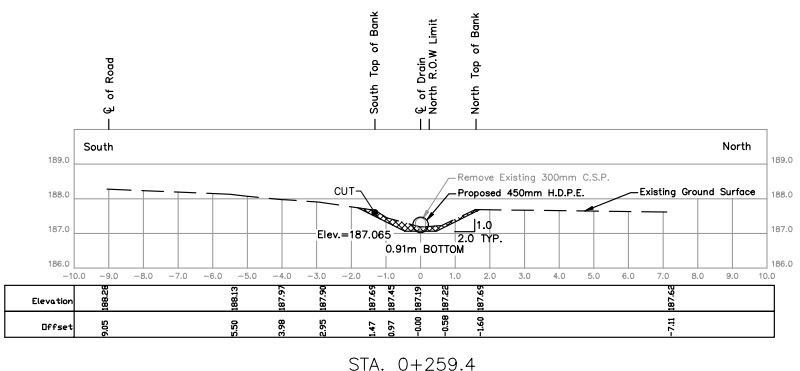

STA. 0+259.4
Scale = 1:100

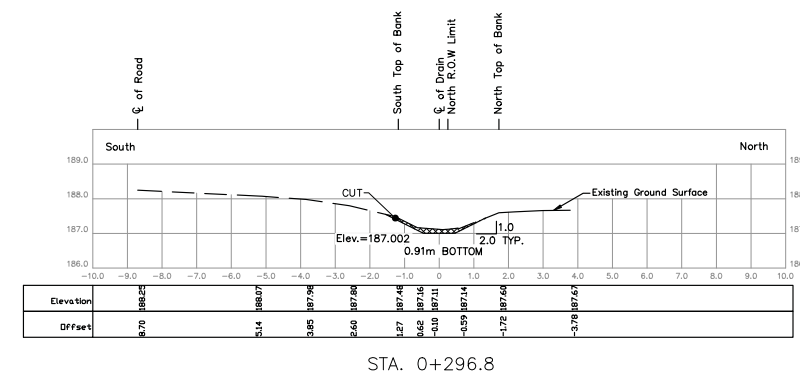

STA. 0+296.8
Scale = 1:100

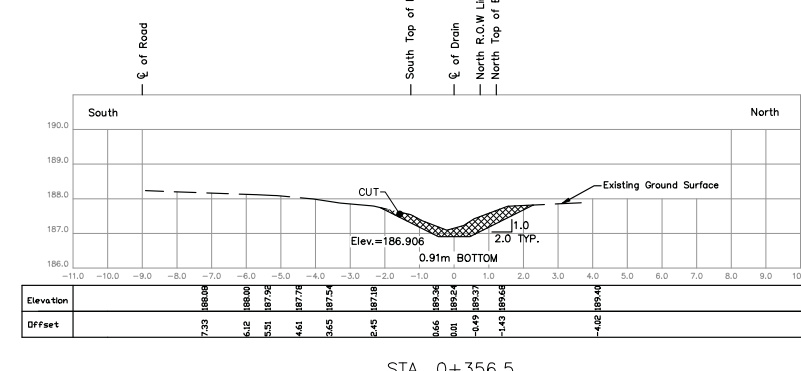

STA. 0+356.5
Scale = 1:100

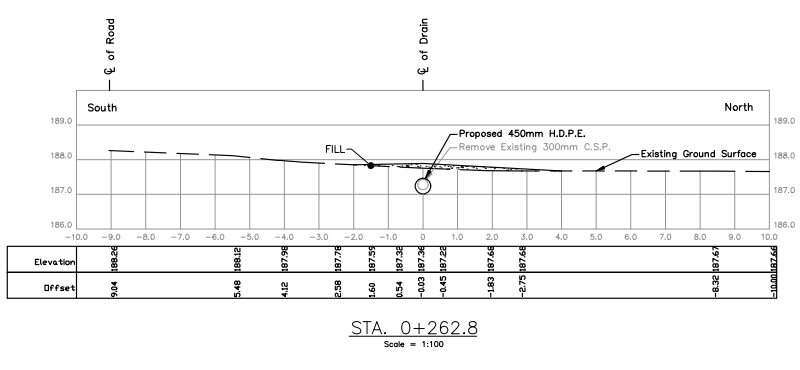

STA. 0+262.8
Scale = 1:100

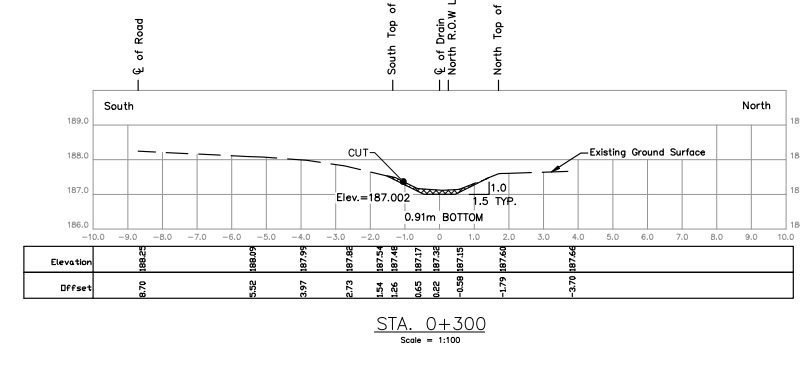

STA. 0+300
Scale = 1:100

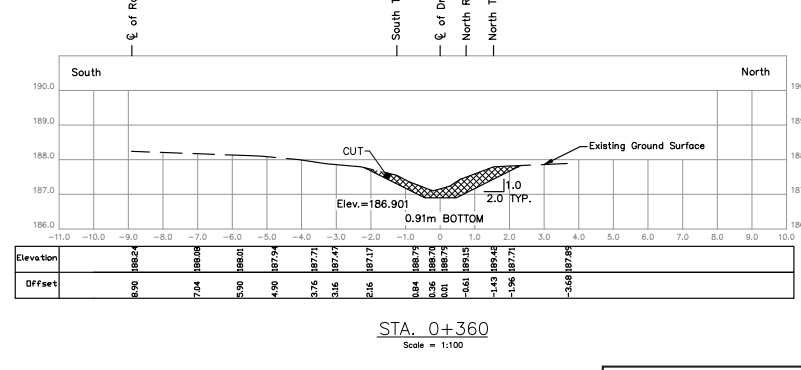

STA. 0+360
Scale = 1:100

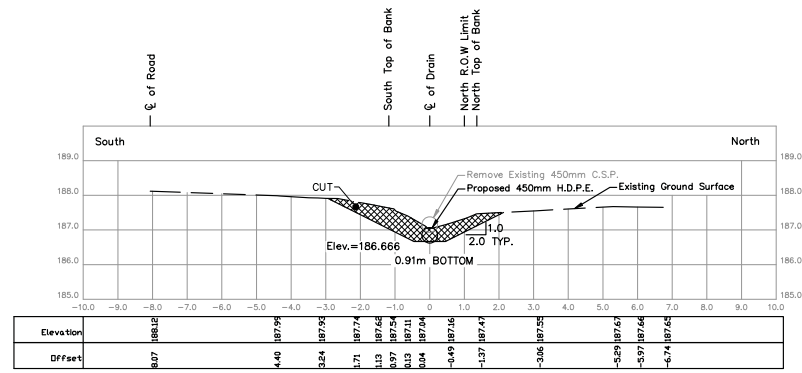

STA. 0+504.2
Scale = 1:100

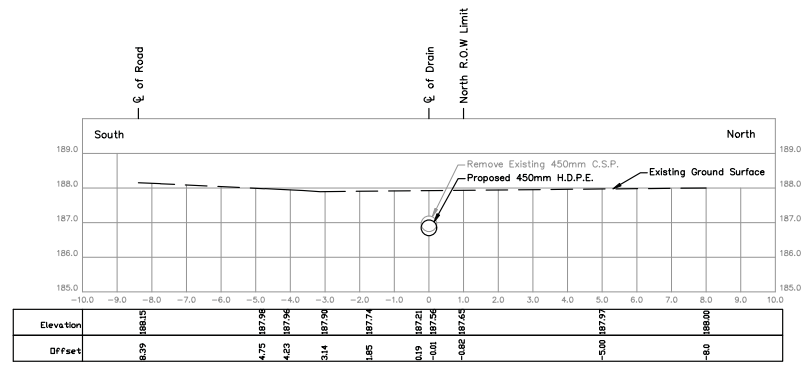

STA. 0+540
Scale = 1:100

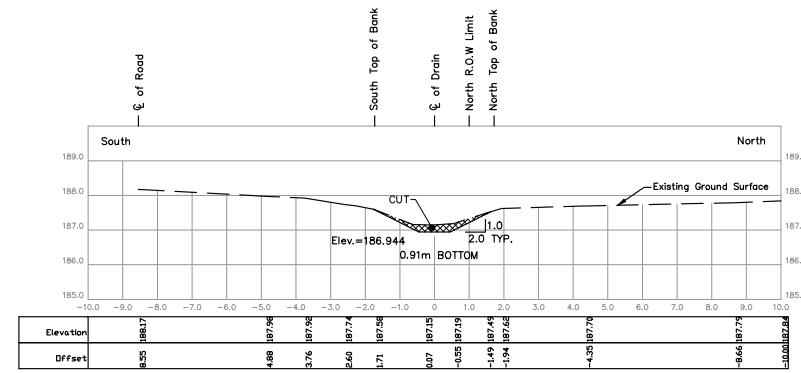

STA. 0+585.2
Scale = 1:100

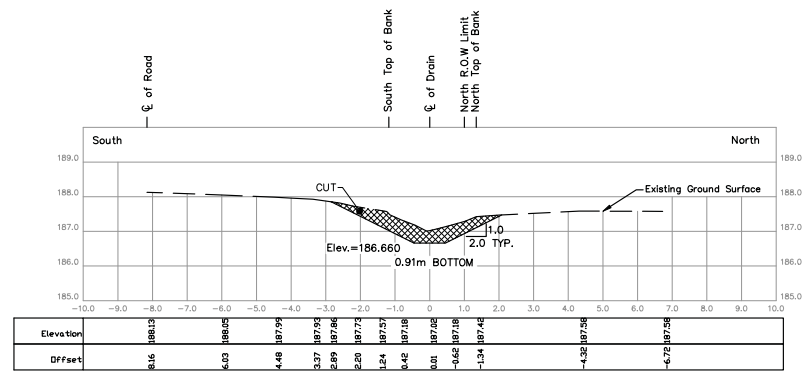

STA. 0+510
Scale = 1:100

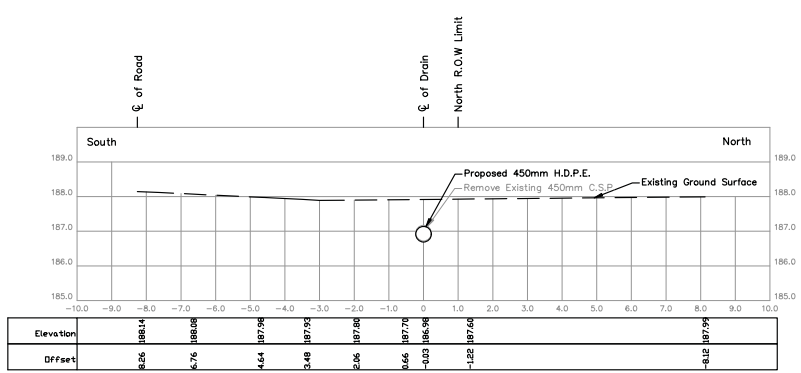

STA. 0+549.1
Scale = 1:100

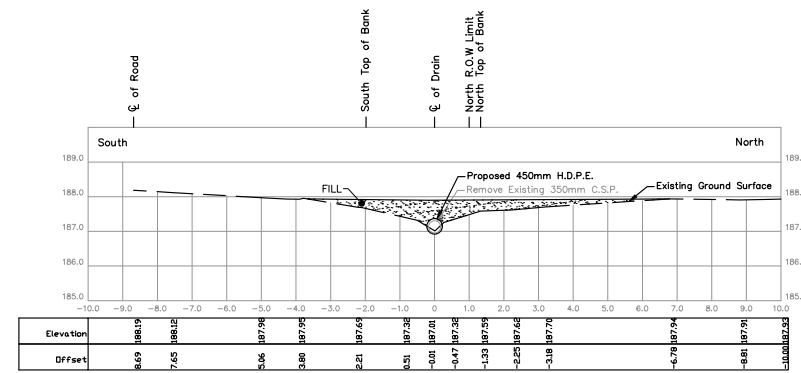

STA. 0+598.3
Scale = 1:100

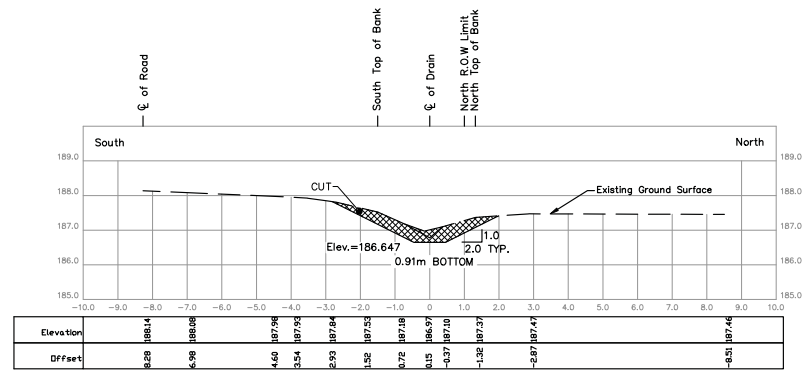

STA. 0+517.6
Scale = 1:100

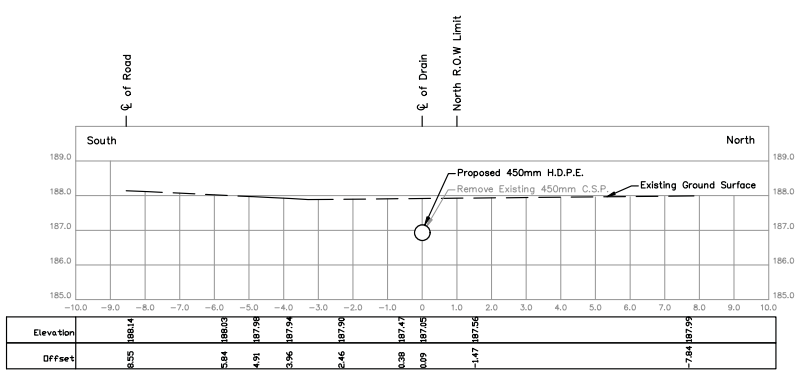

STA. 0+570
Scale = 1:100

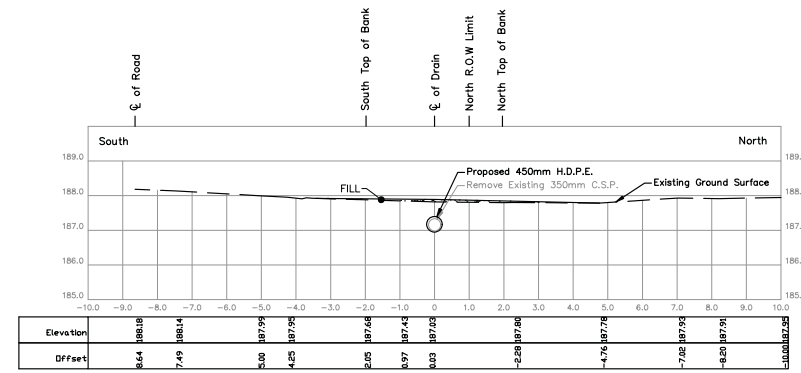

STA. 0+600
Scale = 1:100

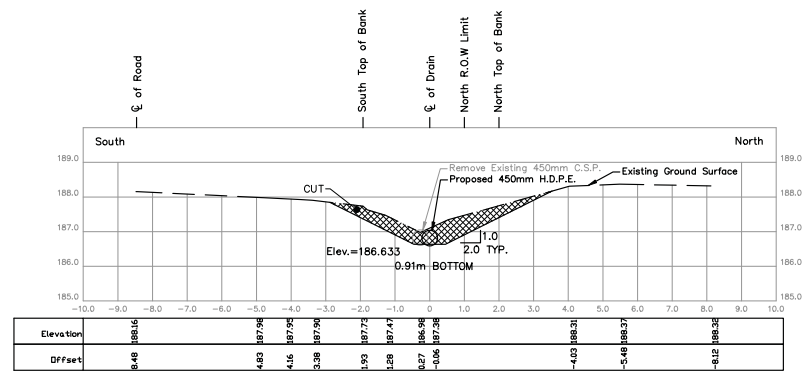

STA. 0+533.6
Scale = 1:100

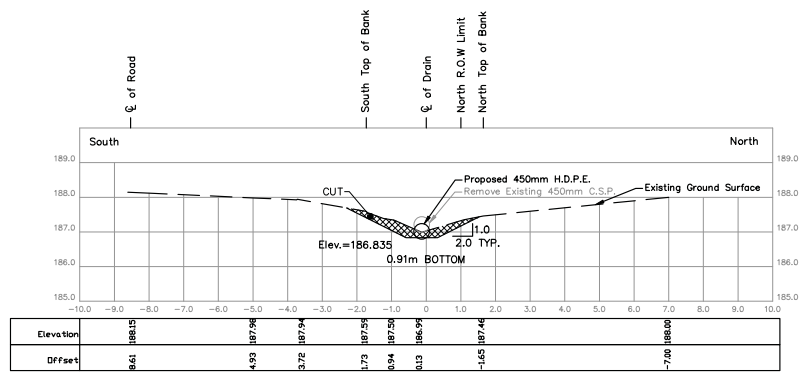

STA. 0+573.3
Scale = 1:100

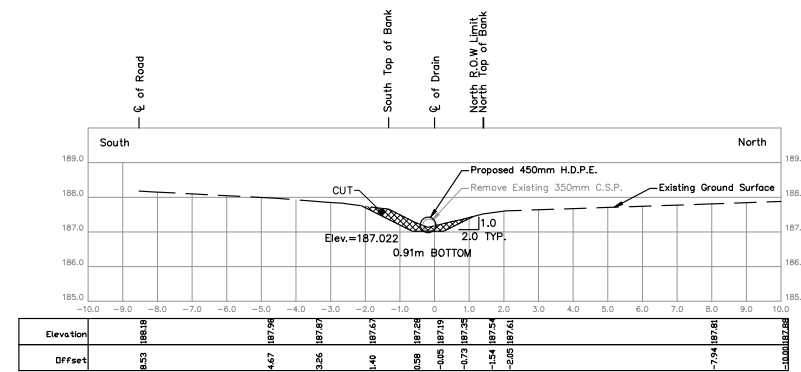

STA. 0+607.7
Scale = 1:100

THESE PLANS HAVE BEEN REDUCED
AND THE SCALE THEREFORE VARIES
FULL SCALE PLANS MAY BE VIEWED
AT THE MUNICIPAL OFFICE.

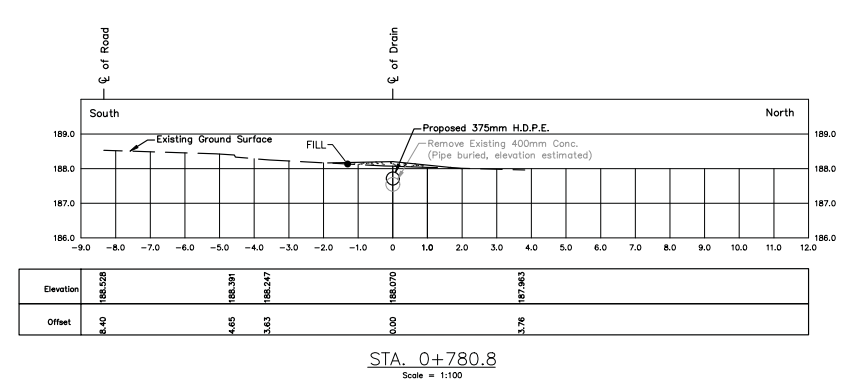
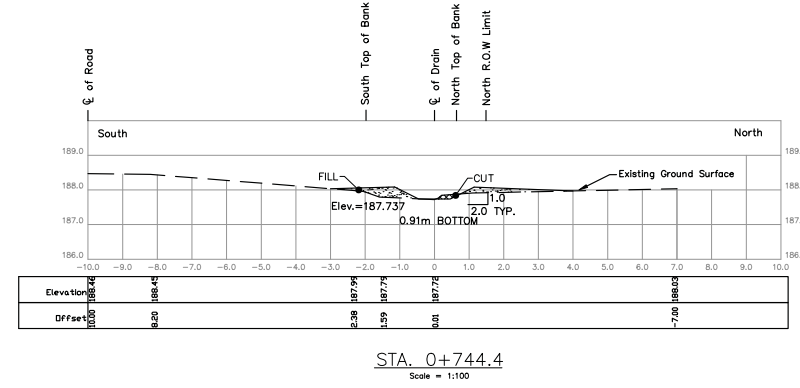
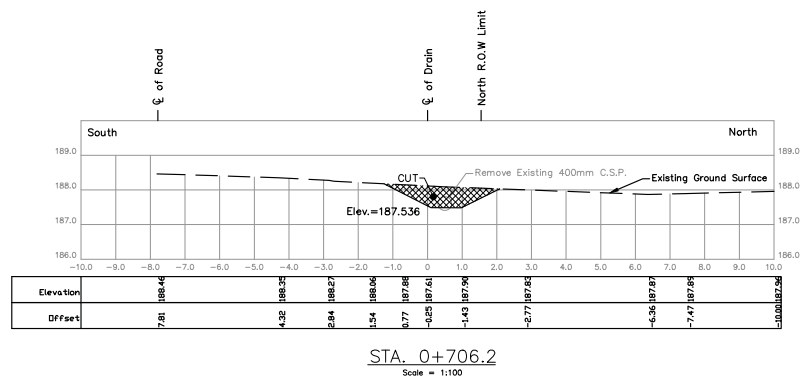
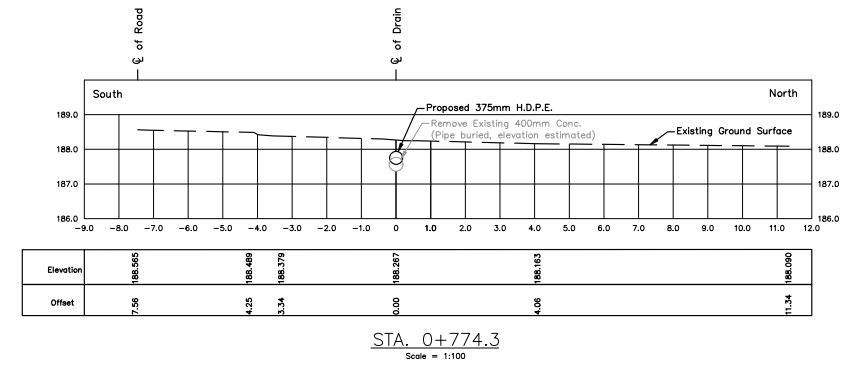
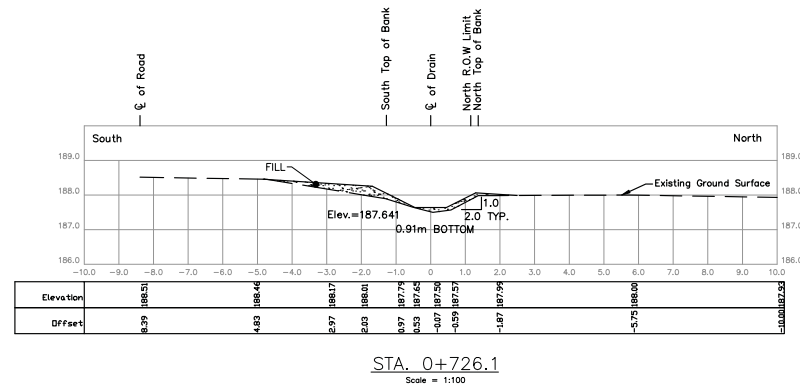
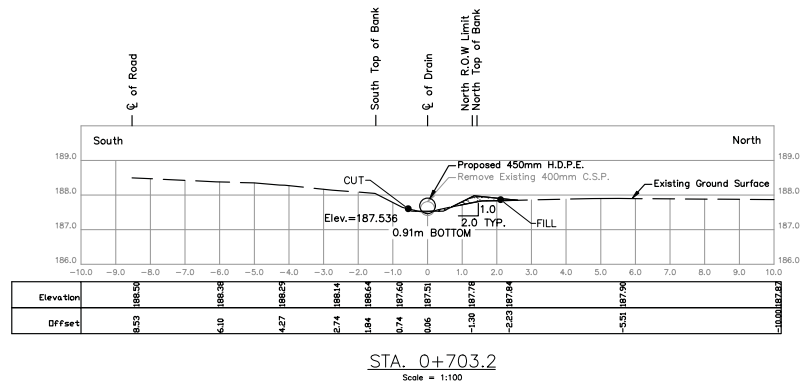

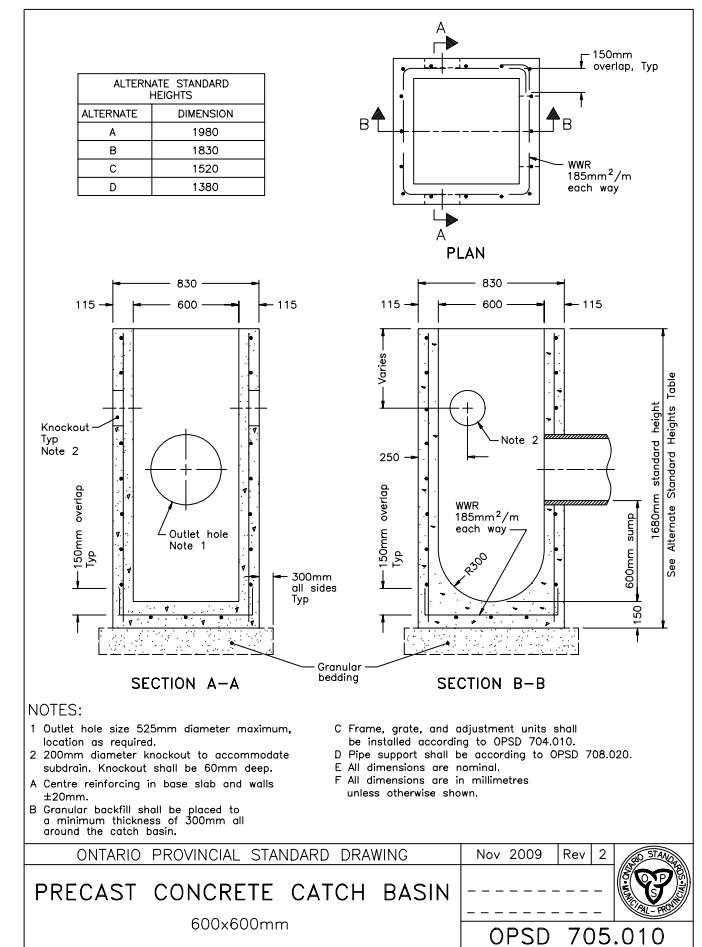
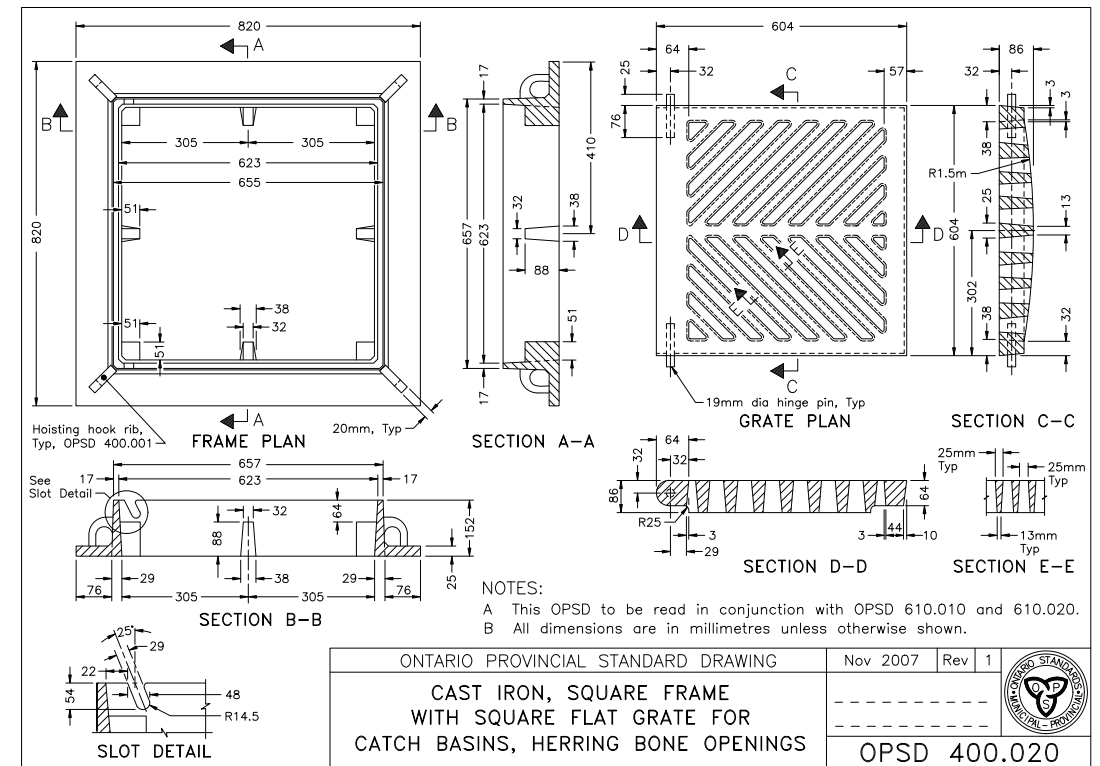
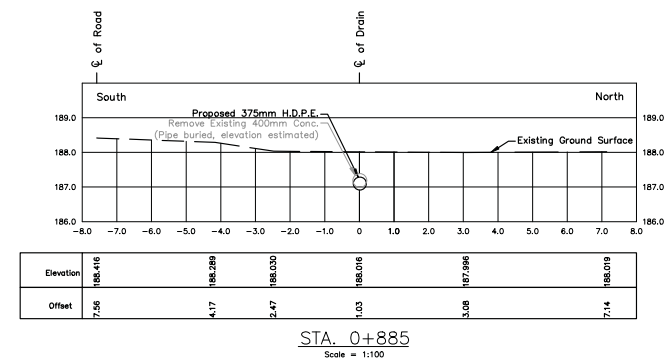
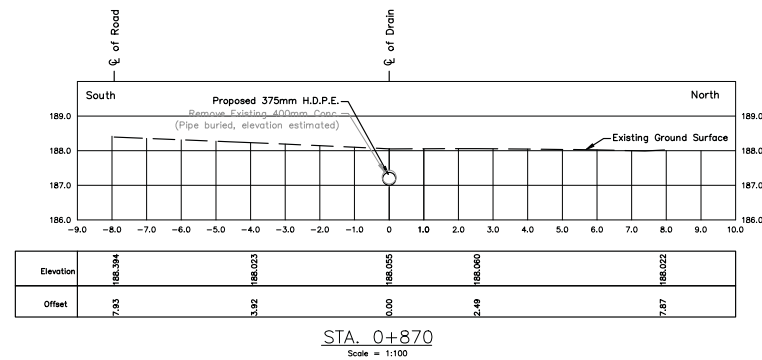
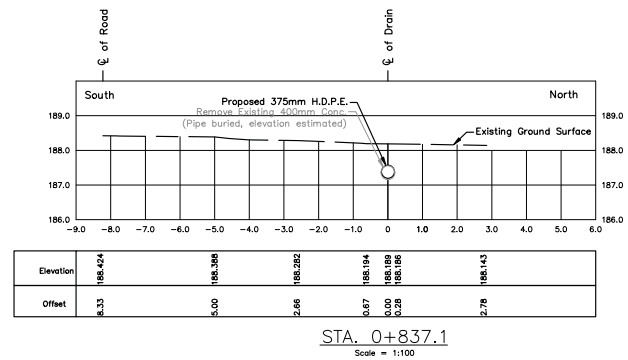
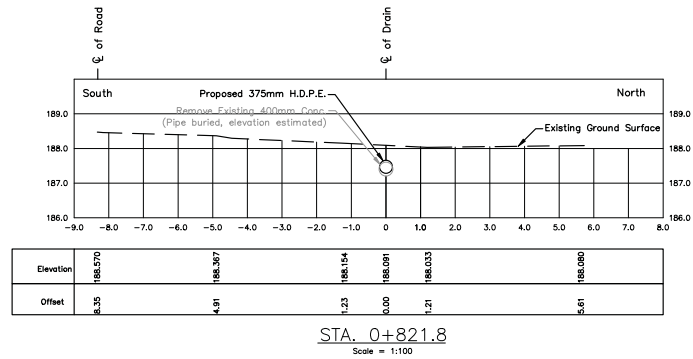

THESE PLANS HAVE BEEN REDUCED AND THE SCALE THEREFORE VARIES. FULL SCALE PLANS MAY BE VIEWED AT THE MUNICIPAL OFFICE.

DRAWN BY: L.V. & K.D.
PLOT CODE: 1:1
COMPUTER FILE: REI2017D020.DWG
FILE No.: REI2017D020
SHEET No.: 9 OF 9

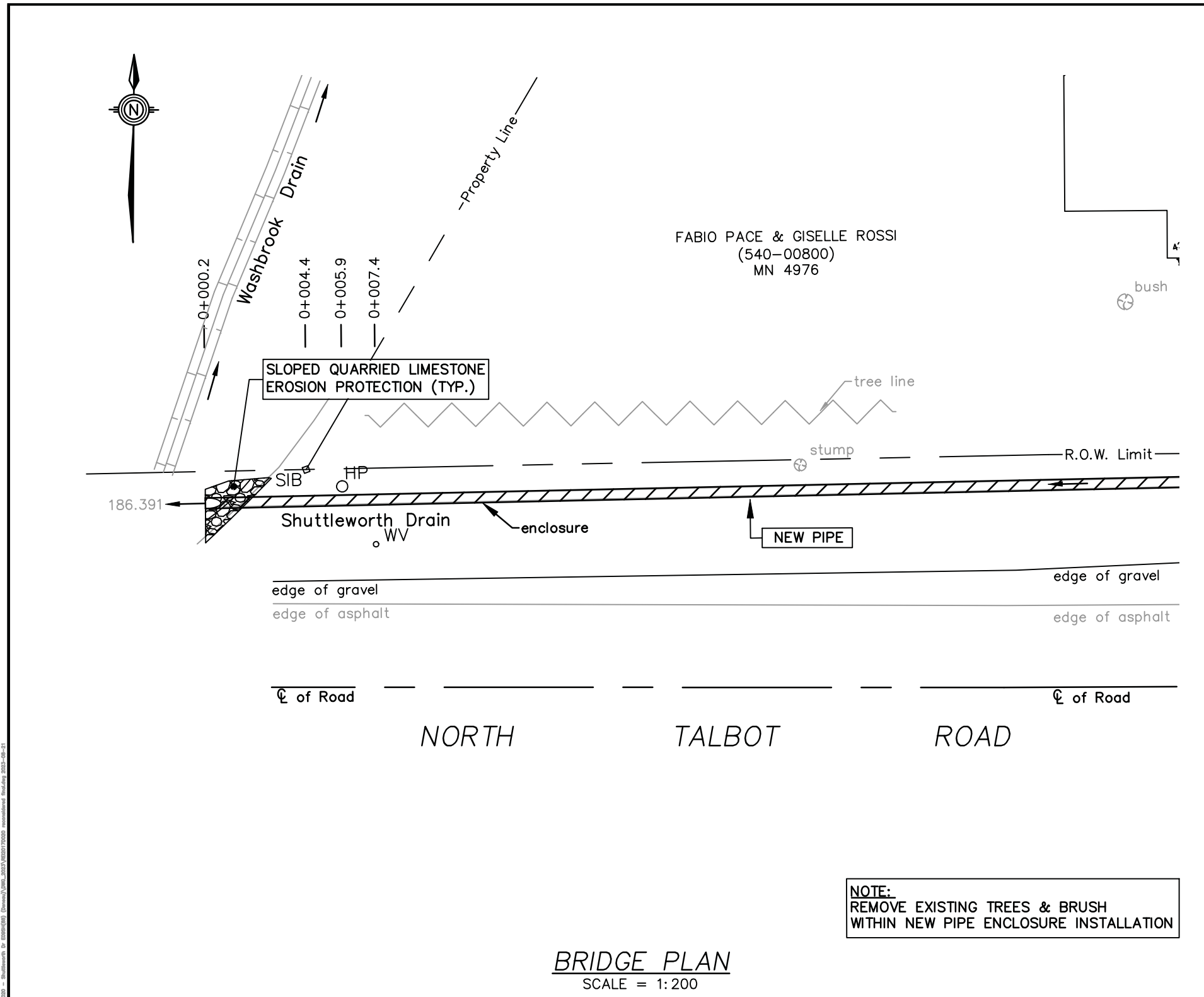

BRIDGE PLAN
SCALE = 1:200

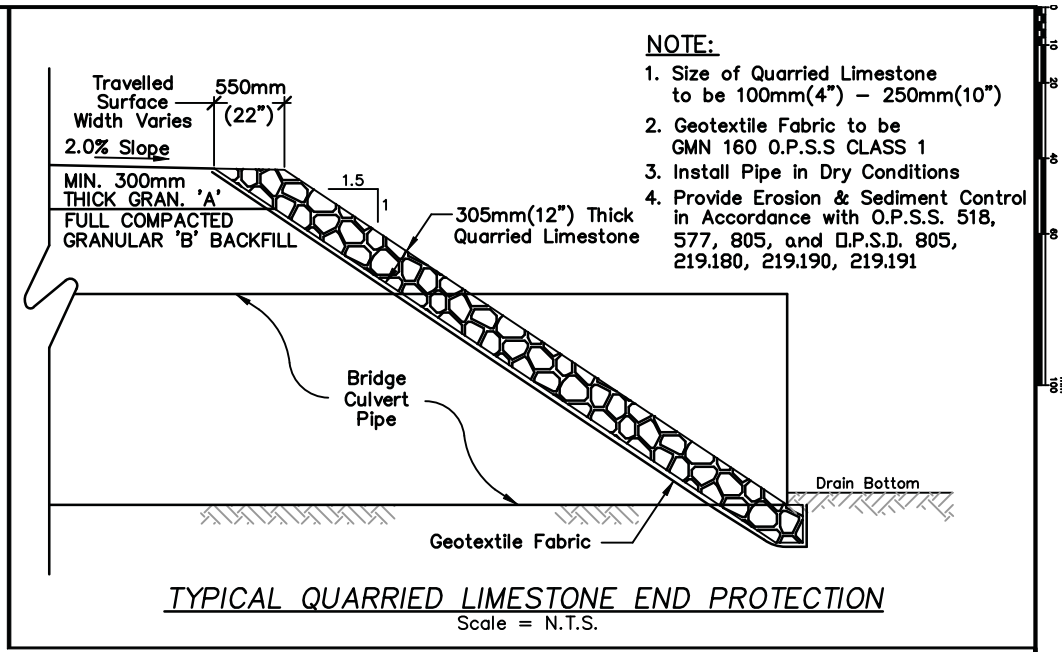

TYPICAL QUARRIED LIMESTONE END PROTECTION
Scale = N.T.S.

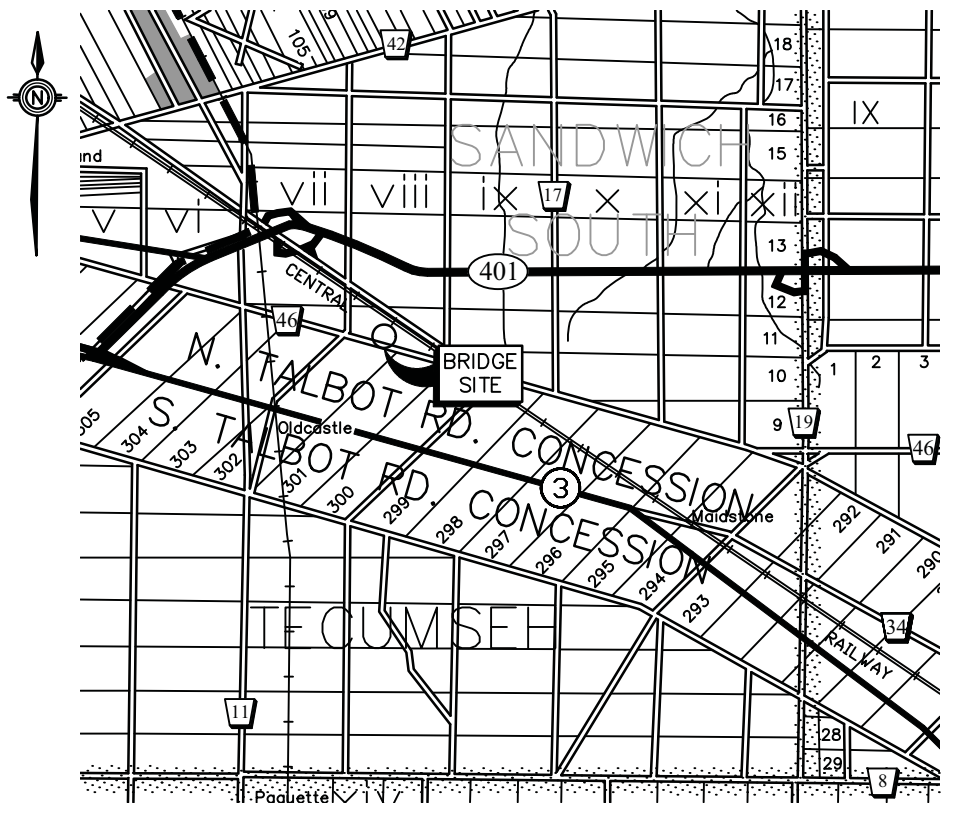

KEY PLAN
Scale = 1:100,000

NOTE:
REMOVE EXISTING TREES & BRUSH
WITHIN NEW PIPE ENCLOSURE INSTALLATION

BENCHMARK:
TOP NUT OF FIRE HYDRANT LOCATED APPROX. 17.5 METRES EAST OF THE EAST END OF PROPOSED BRIDGE FRONTING MN 5074 ON THE NORTH SIDE OF NORTH TALBOT ROAD
ELEV. = 188.722m

PIPE SIZE:	PIPE LENGTH:	PIPE GAUGE:	CORRUGATIONS:	TYPE OF PIPE:	DESIGN ELEVATIONS:
450mm ϕ	60.0m (196.85 FT.)	320 kPa	STANDARD	SMOOTH WALL H.D.P.E. PIPE	UPSTREAM INV. (E) = 187.330m DOWNSTREAM INV. (W) = 187.030m ϕ TOP OF DRIVEWAY = 188.144m DRAIN GRADE = 0.50%

SHUTTLEWORTH DRAIN
BRIDGE WEST PORTION FOR FABIO PACE & GISELLE ROSSI (540-00800)
(GEOGRAPHIC TOWNSHIP OF SANDWICH SOUTH)
IN THE
TOWN OF TECUMSEH
IN THE
COUNTY OF ESSEX • ONTARIO

ROOD ENGINEERING INC.
CONSULTING ENGINEERS
Leamington, Ontario
519-322-1621

DATE: 2023-08-21
FILE No.: 2017D020
DRAWN BY: K.D.
PLOT CODE: 1:1
FILE: REI2017D020.DWG
APPENDIX 'E'
1 OF 17

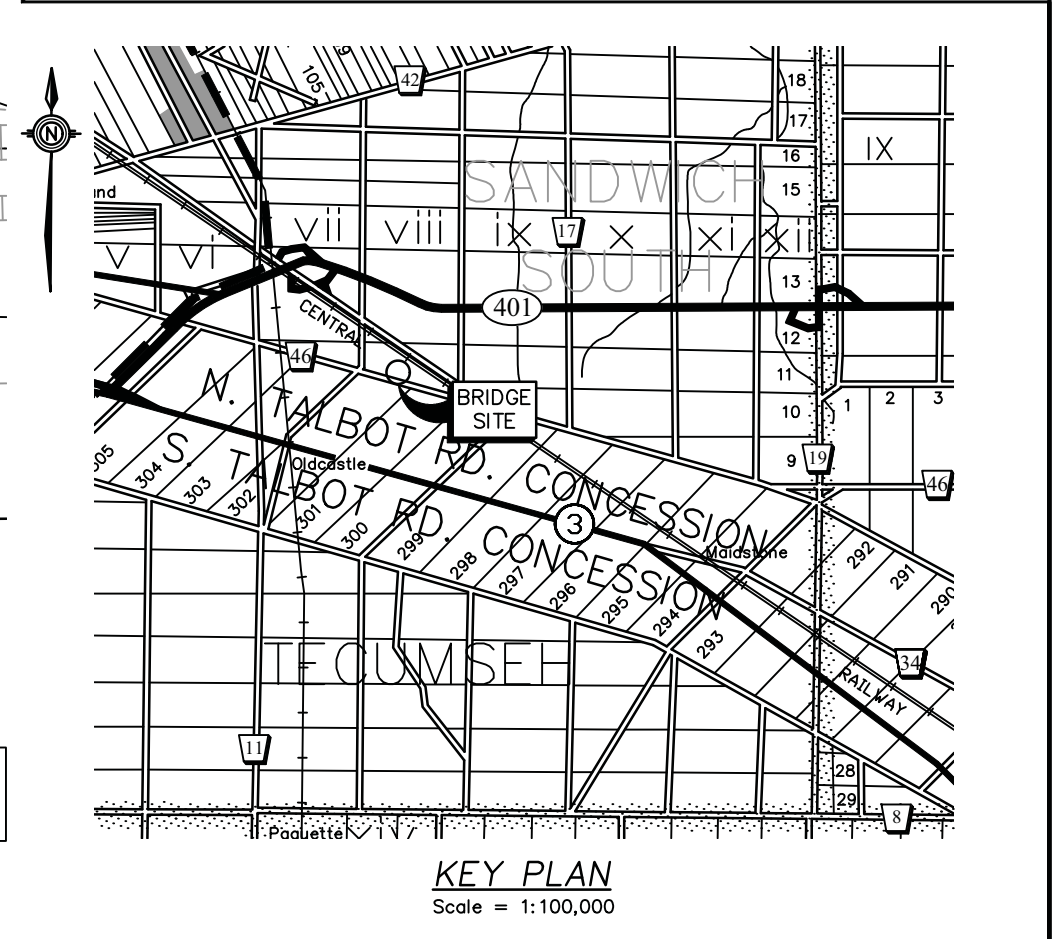
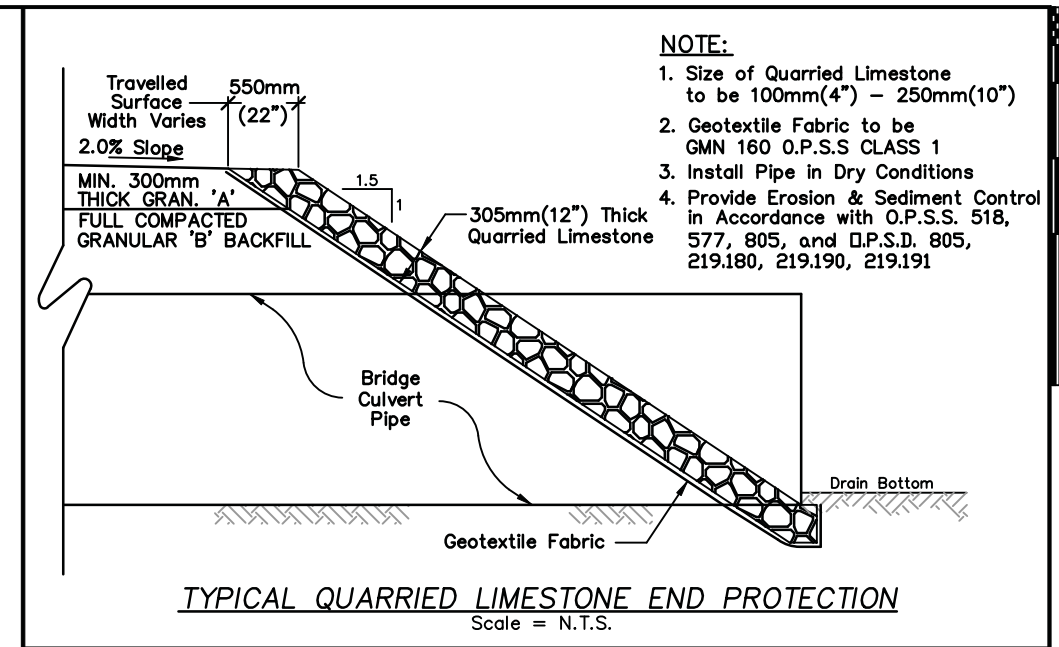
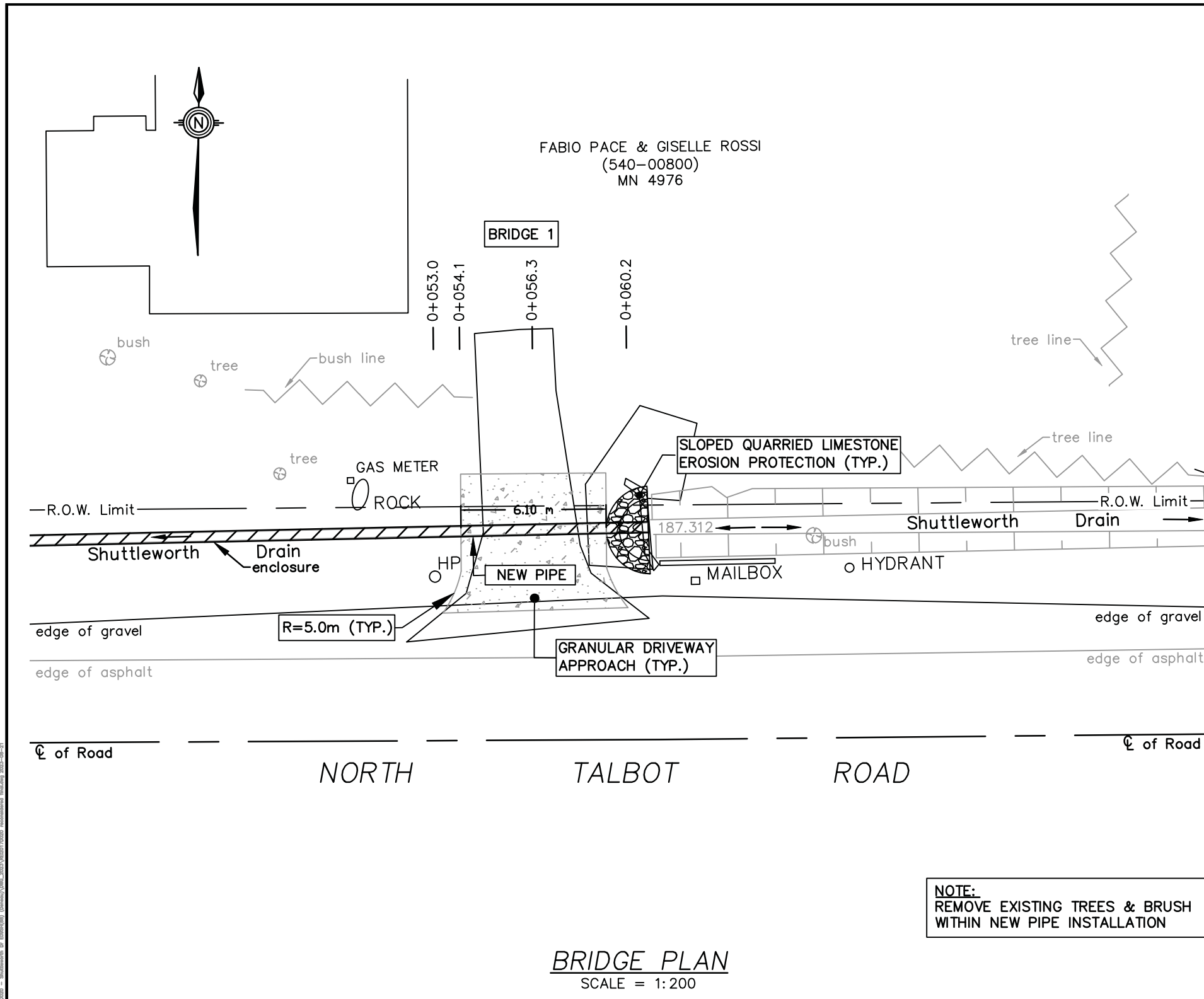

NOTE:
REMOVE EXISTING TREES & BRUSH
WITHIN NEW PIPE INSTALLATION

BENCHMARK:
TOP NUT OF FIRE HYDRANT LOCATED APPROX. 17.5 METRES EAST OF THE EAST END OF PROPOSED BRIDGE FRONTING MN 5074 ON THE NORTH SIDE OF NORTH TALBOT ROAD
ELEV. = 188.722m

PIPE SIZE:	PIPE LENGTH:	PIPE GAUGE:	CORRUGATIONS:	TYPE OF PIPE:	DESIGN ELEVATIONS:
450mm ϕ	60.0m (196.85 FT.)	320 kPa	STANDARD	SMOOTH WALL H.D.P.E. PIPE	UPSTREAM INV. (E) = 187.330m DOWNSTREAM INV. (W) = 187.030m ϕ TOP OF DRIVEWAY = 188.144m DRAIN GRADE = 0.50%

SHUTTLEWORTH DRAIN
BRIDGE EAST PORTION FOR FABIO PACE & GISELLE ROSSI (540-00800)
(GEOGRAPHIC TOWNSHIP OF SANDWICH SOUTH)
IN THE
TOWN OF TECUMSEH
IN THE
COUNTY OF ESSEX • ONTARIO

ROAD ENGINEERING INC.
CONSULTING ENGINEERS
Leamington, Ontario
519-322-1621

FILE No.: 2017D020	DRAWN BY: K.D. PLOT CODE: 1:1 FILE: REI2017D020.DWG	DATE: 2023-08-21
APPENDIX 'E'		2 OF 17

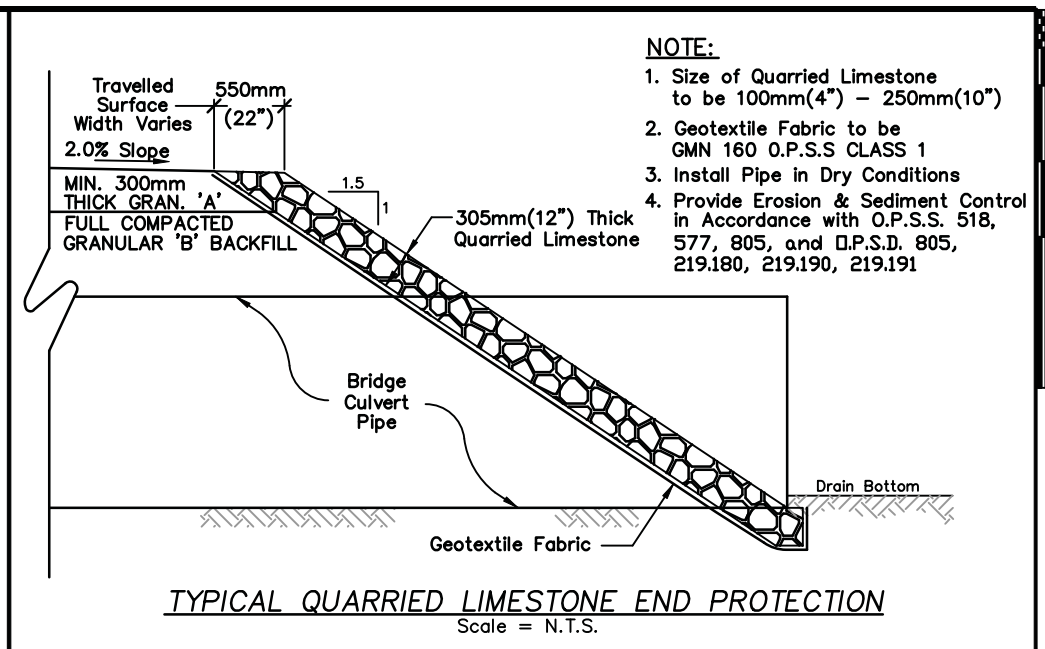
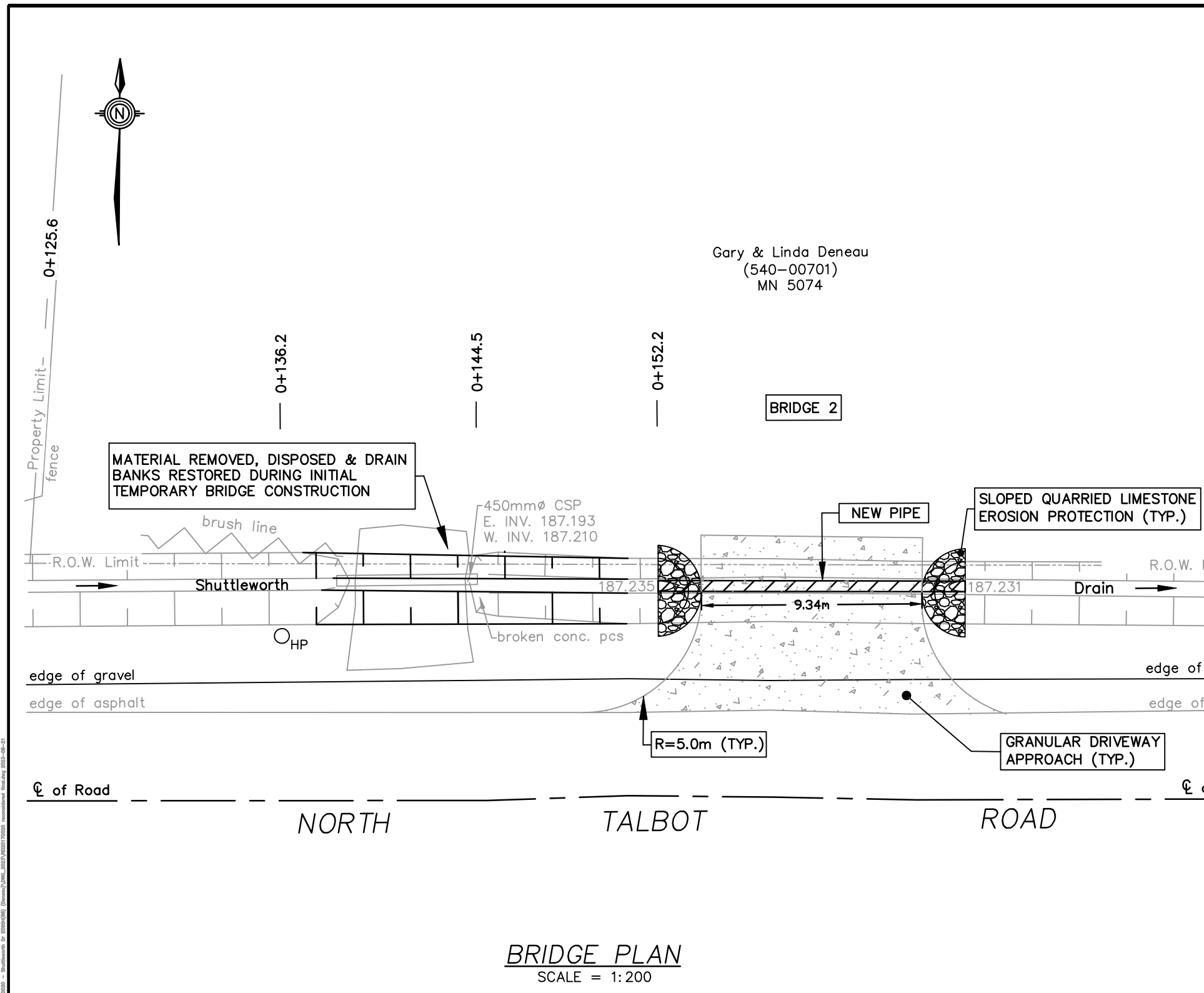

- NOTE:**
1. Size of Quarried Limestone to be 100mm(4") - 250mm(10")
 2. Geotextile Fabric to be GMN 160 O.P.S.S CLASS 1
 3. Install Pipe in Dry Conditions
 4. Provide Erosion & Sediment Control in Accordance with O.P.S.S. 518, 577, 805, and O.P.S.D. 805, 219.180, 219.190, 219.191

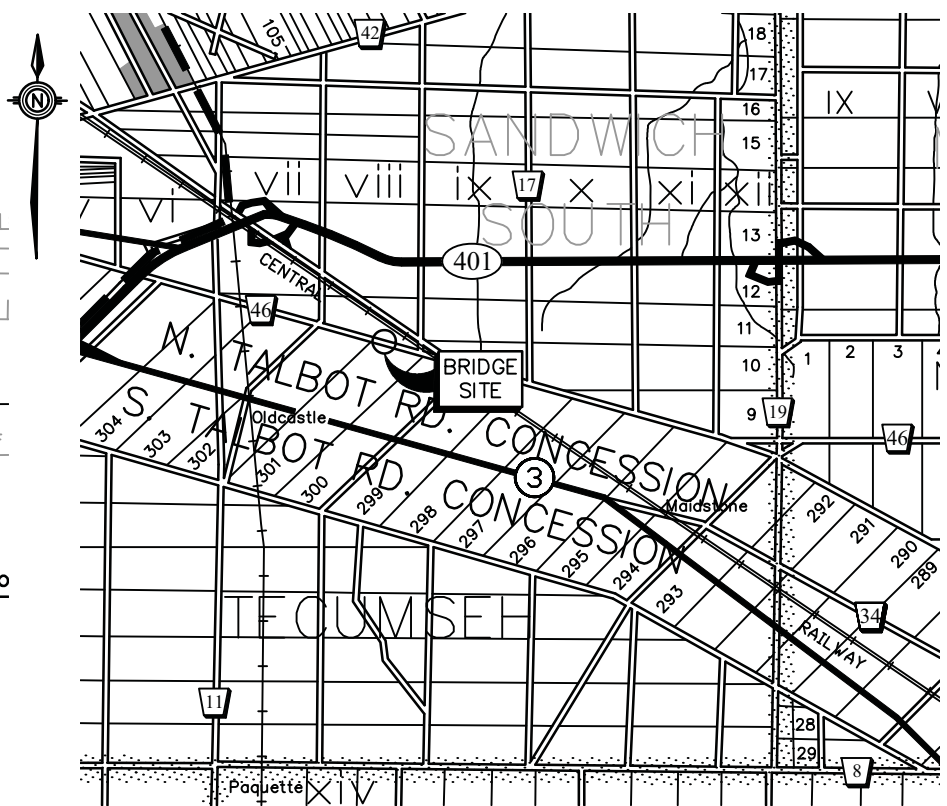

BENCHMARK:
TOP NUT OF FIRE HYDRANT LOCATED APPROX. 17.5 METRES EAST OF THE EAST END OF PROPOSED BRIDGE FRONTING MN 5074 ON THE NORTH SIDE OF NORTH TALBOT ROAD
ELEV. = 188.722m

PIPE SIZE:	PIPE LENGTH:	PIPE GAUGE:	CORRUGATIONS:	TYPE OF PIPE:	DESIGN ELEVATIONS:
450mmØ	13.0m (42.65 FT.)	320 kPa	STANDARD	SMOOTH WALL H.D.P.E. PIPE	UPSTREAM INV. (W) = 187.190m DOWNSTREAM INV. (E) = 187.170m ¢ TOP OF DRIVEWAY = 188.020m DRAIN GRADE = 0.16%

SHUTTLEWORTH DRAIN
BRIDGE FOR GARY & LINDA DENEAU (540-00701)
(GEOGRAPHIC TOWNSHIP OF SANDWICH SOUTH)
IN THE
TOWN OF TECUMSEH
IN THE
COUNTY OF ESSEX • ONTARIO

ROOD ENGINEERING INC.
CONSULTING ENGINEERS
Leamington, Ontario
519-322-1621

DATE: 2023-08-21

FILE No.: 2017D020	DRAWN BY: K.S. PLOT CODE: 1:1 FILE: REI2017D020.DWG	APPENDIX 'E' 3 OF 17
-----------------------	---	--------------------------------



Gary & Linda Deneau
(540-00701)
MN 5074

Linda Deneau
(540-00703)
MN 5078

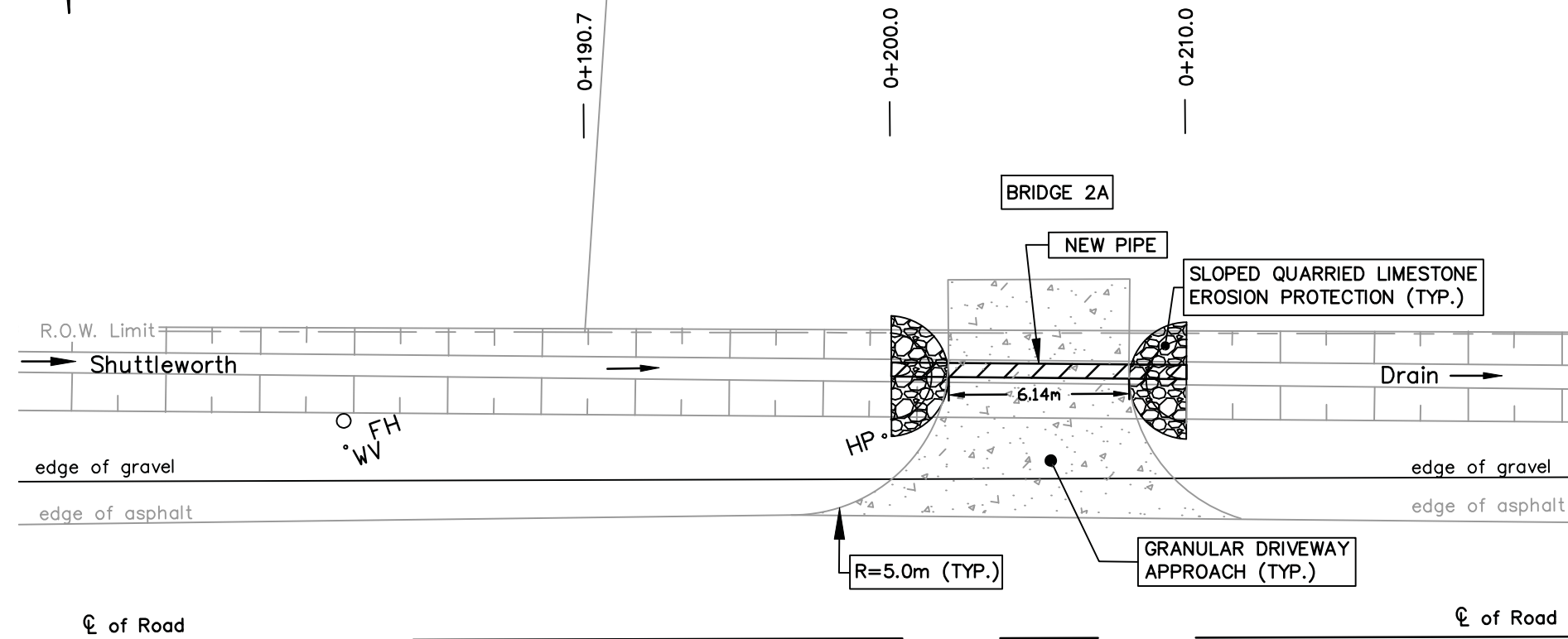

BRIDGE PLAN
SCALE = 1:200

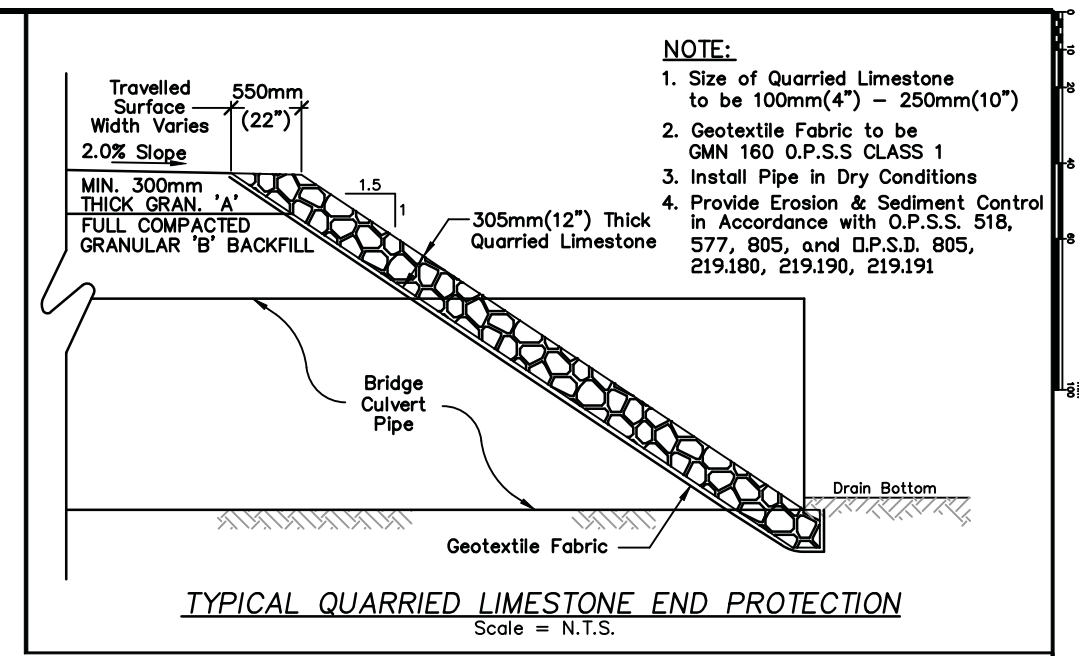

TYPICAL QUARRIED LIMESTONE END PROTECTION
Scale = N.T.S.

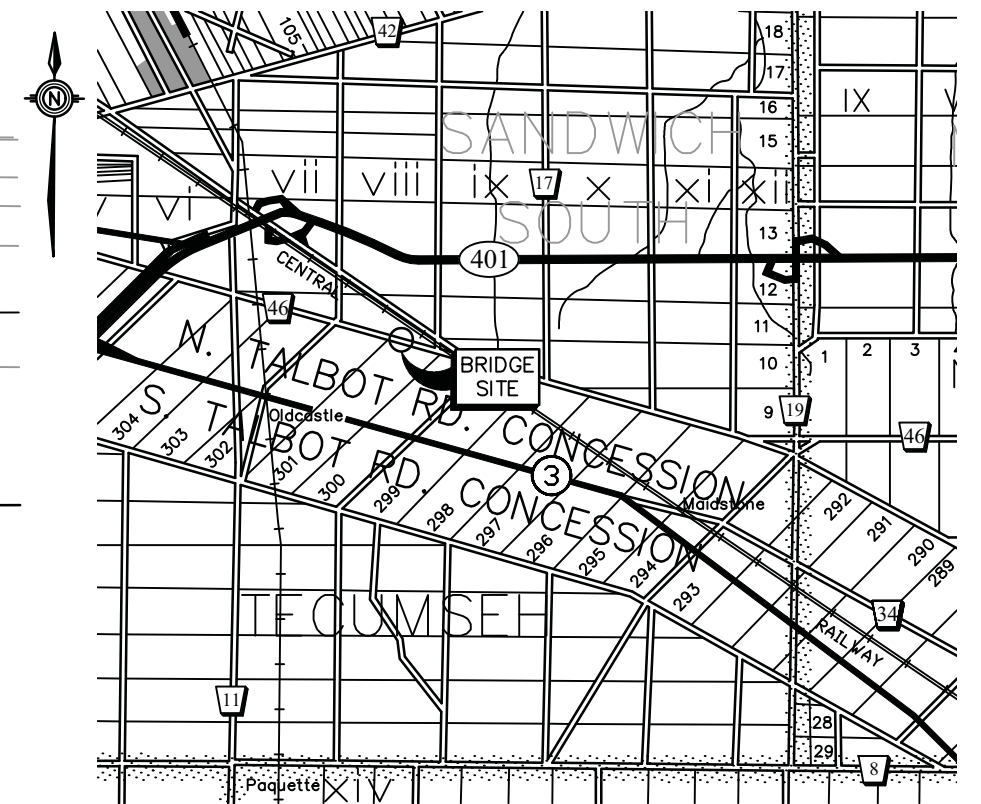

KEY PLAN
Scale = 1:100,000

BENCHMARK:
TOP NUT OF FIRE HYDRANT LOCATED APPROX. 17.5 METRES EAST OF THE EAST END OF PROPOSED BRIDGE FRONTING MN 5074 ON THE NORTH SIDE OF NORTH TALBOT ROAD
ELEV. = 188.722m

PIPE SIZE:	PIPE LENGTH:	PIPE GAUGE:	CORRUGATIONS:	TYPE OF PIPE:	DESIGN ELEVATIONS:
450mm ϕ	10.0m (32.8 FT.)	320 kPa	STANDARD	SMOOTH WALL H.D.P.E. PIPE	UPSTREAM INV. (W) = 187.115m DOWNSTREAM INV. (E) = 187.099m ϕ TOP OF DRIVEWAY = 188.020m DRAIN GRADE = 0.16%

SHUTTLEWORTH DRAIN
BRIDGE FOR LINDA DENEAU (540-00703)
(GEOGRAPHIC TOWNSHIP OF SANDWICH SOUTH)
IN THE
TOWN OF TECUMSEH
IN THE
COUNTY OF ESSEX • ONTARIO

ROOD ENGINEERING INC.
CONSULTING ENGINEERS
Leamington, Ontario
519-322-1621

FILE No.: 2017D020	DRAWN BY: K.S. & G.R. PLOT CODE: 1:1 FILE: REI2017D020.DWG	DATE: 2023-08-21	APPENDIX 'E' 4 OF 17
-----------------------	--	------------------	-------------------------

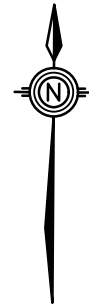

LINDA DENEAU
(540-00703)
MN 5078

TOWN OF TECUMSEH
(540-00700)
MN 5284

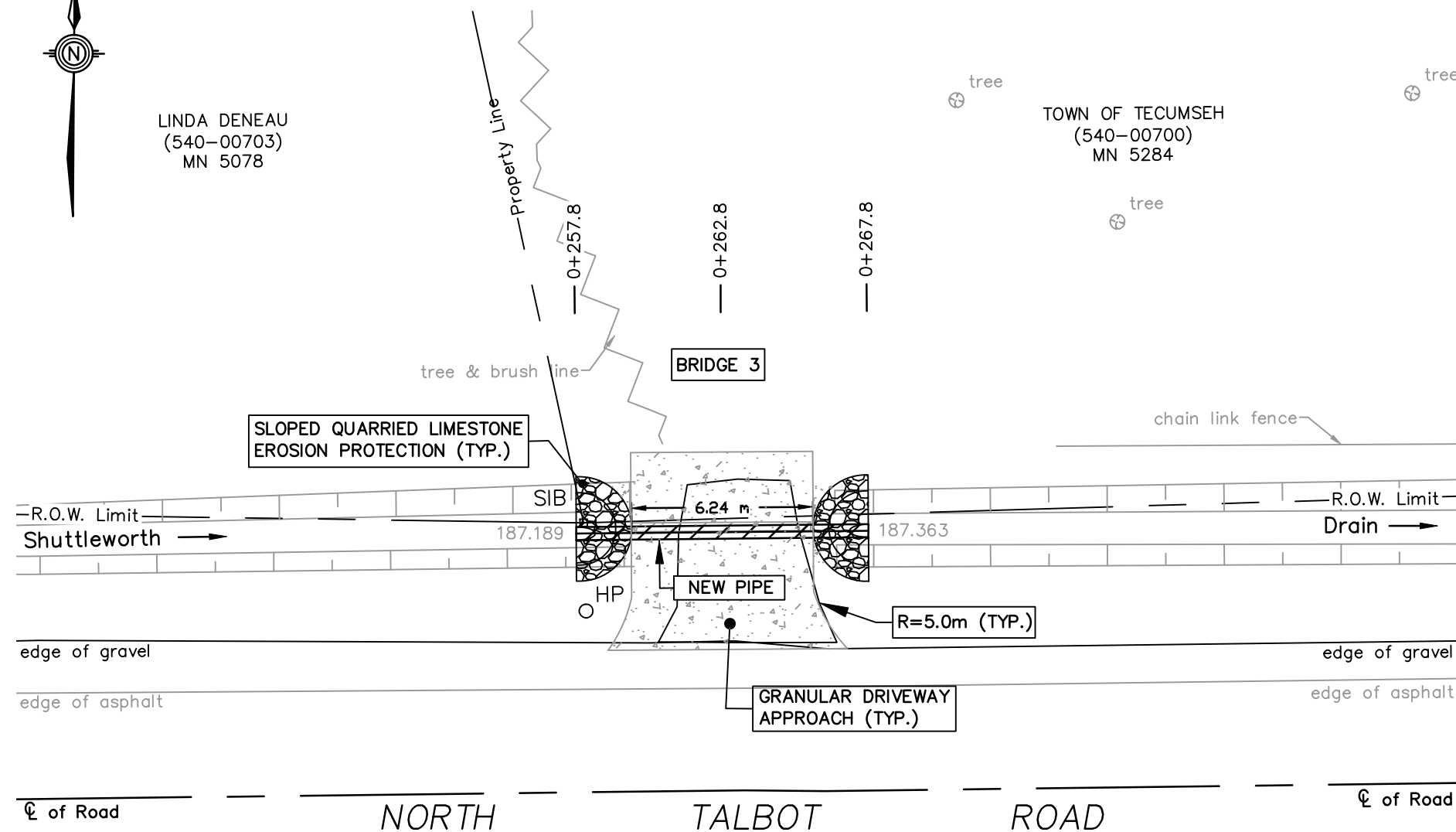

BRIDGE PLAN
SCALE = 1:200

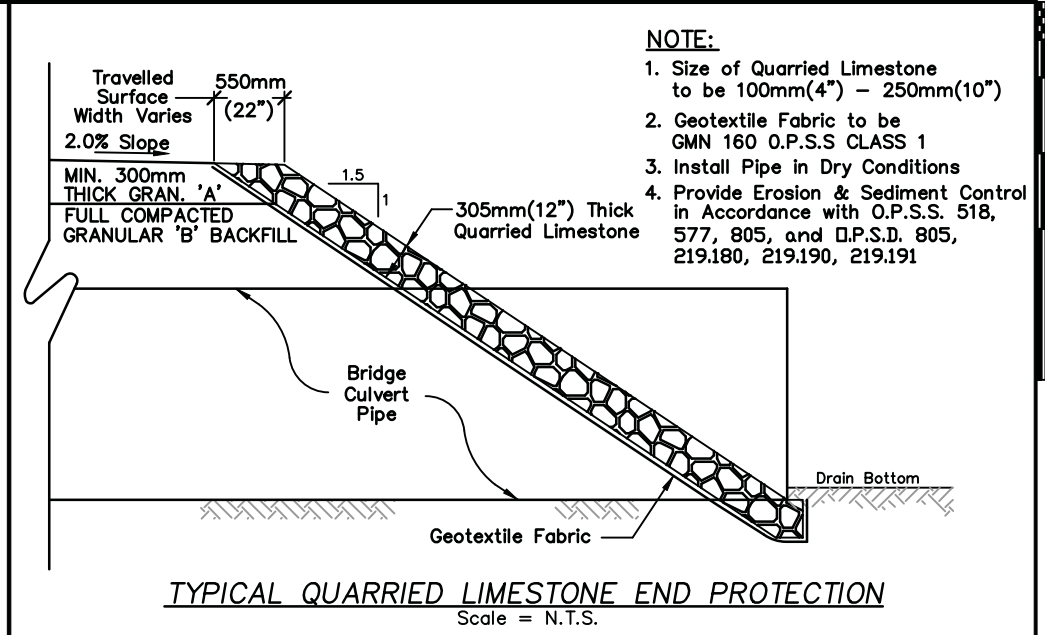

- NOTE:**
1. Size of Quarried Limestone to be 100mm(4") - 250mm(10")
 2. Geotextile Fabric to be GMN 160 O.P.S.S CLASS 1
 3. Install Pipe in Dry Conditions
 4. Provide Erosion & Sediment Control in Accordance with O.P.S.S. 518, 577, 805, and O.P.S.D. 805, 219.180, 219.190, 219.191

TYPICAL QUARRIED LIMESTONE END PROTECTION
Scale = N.T.S.

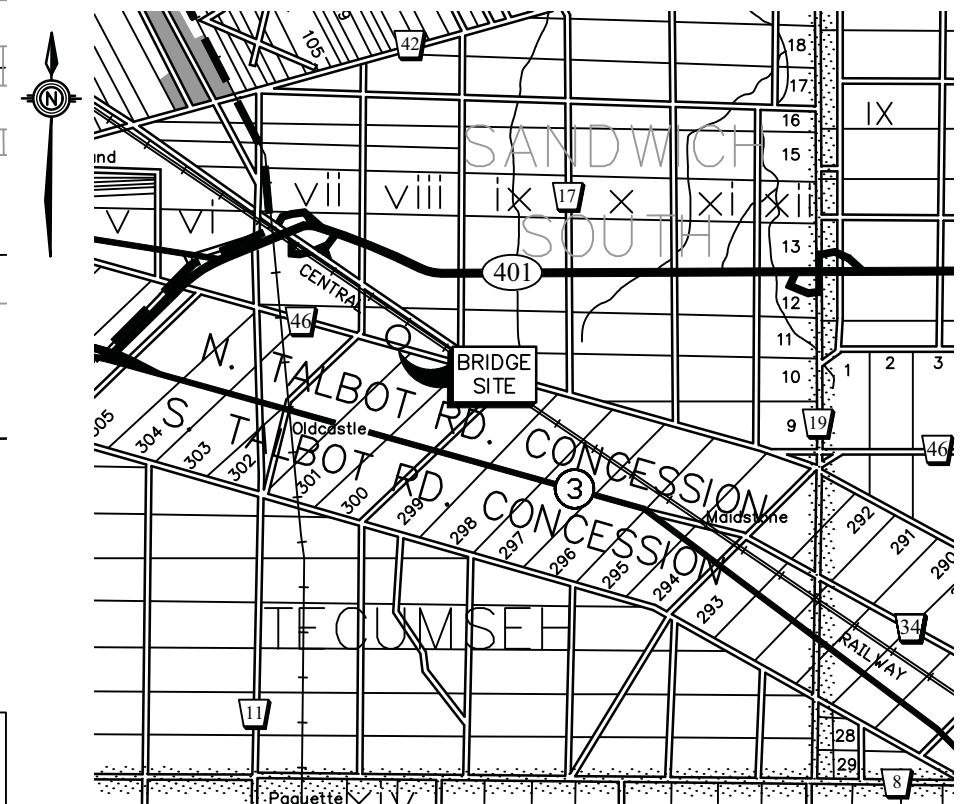

KEY PLAN
Scale = 1:100,000

NOTE:
REMOVE EXISTING TREES & BRUSH WITHIN NEW BRIDGE INSTALLATION

BENCHMARK:
TOP NUT OF FIRE HYDRANT LOCATED APPROX. 17.5 METRES EAST OF THE EAST END OF PROPOSED BRIDGE FRONTING MN 5074 ON THE NORTH SIDE OF NORTH TALBOT ROAD
ELEV. = 188.722m

PIPE SIZE:	PIPE LENGTH:	PIPE GAUGE:	CORRUGATIONS:	TYPE OF PIPE:	DESIGN ELEVATIONS:
450mm ϕ	10.0m (32.80 FT.)	320 kPa	STANDARD	SMOOTH WALL H.D.P.E. PIPE	UPSTREAM INV. (W) = 187.020m DOWNSTREAM INV. (E) = 187.004m CL TOP OF DRIVEWAY = 187.891m DRAIN GRADE = 0.16%

SHUTTLEWORTH DRAIN
BRIDGE FOR TOWN OF TECUMSEH (540-00700) (WEST ENTRANCE)
(GEOGRAPHIC TOWNSHIP OF SANDWICH SOUTH)
IN THE
TOWN OF TECUMSEH
IN THE
COUNTY OF ESSEX • ONTARIO

ROOD ENGINEERING INC.
CONSULTING ENGINEERS
Leamington, Ontario
519-322-1621

FILE No.: 2017D020
DRAWN BY: K.D.
PLOT CODE: 1:1
FILE: REI2017D020.DWG

DATE: 2023-08-21
APPENDIX 'E'
5 OF 17

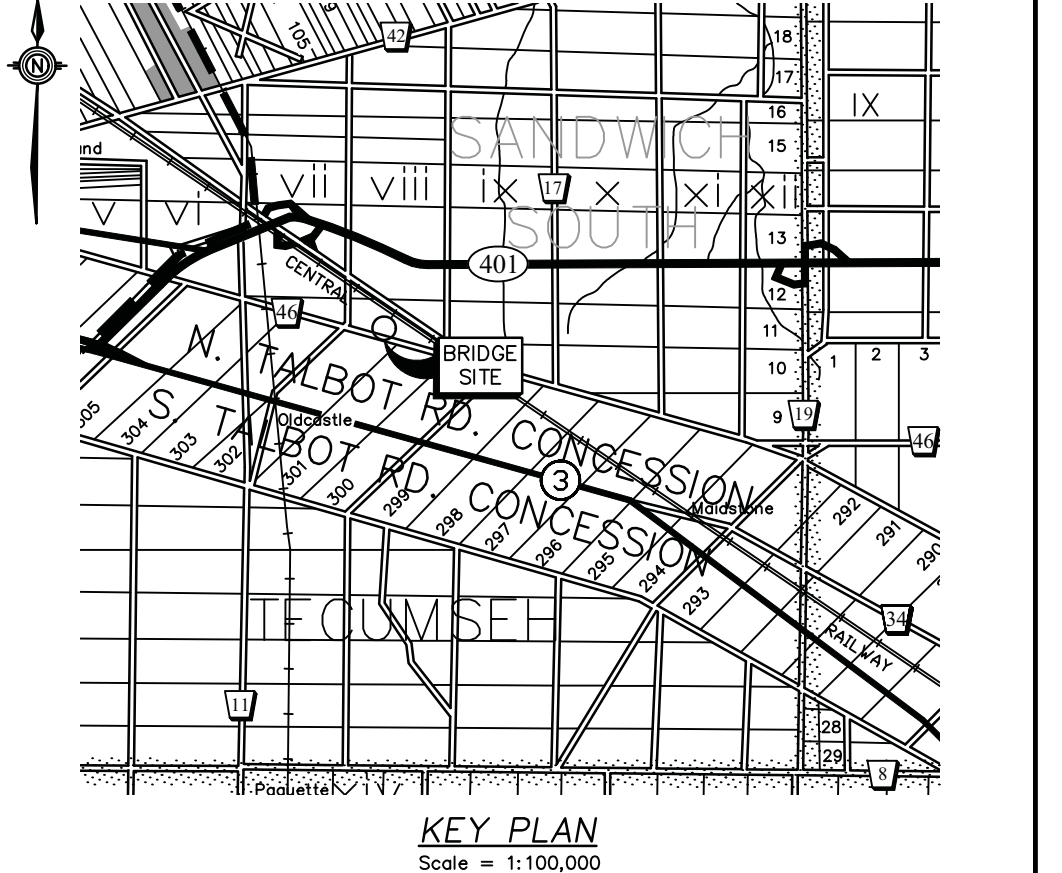
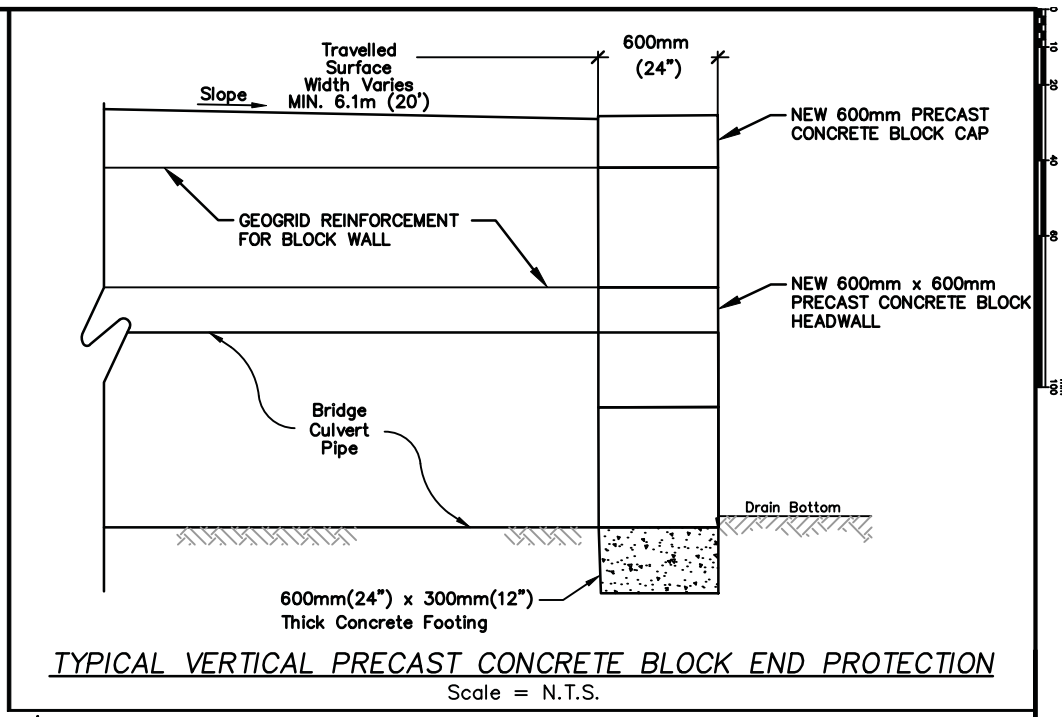
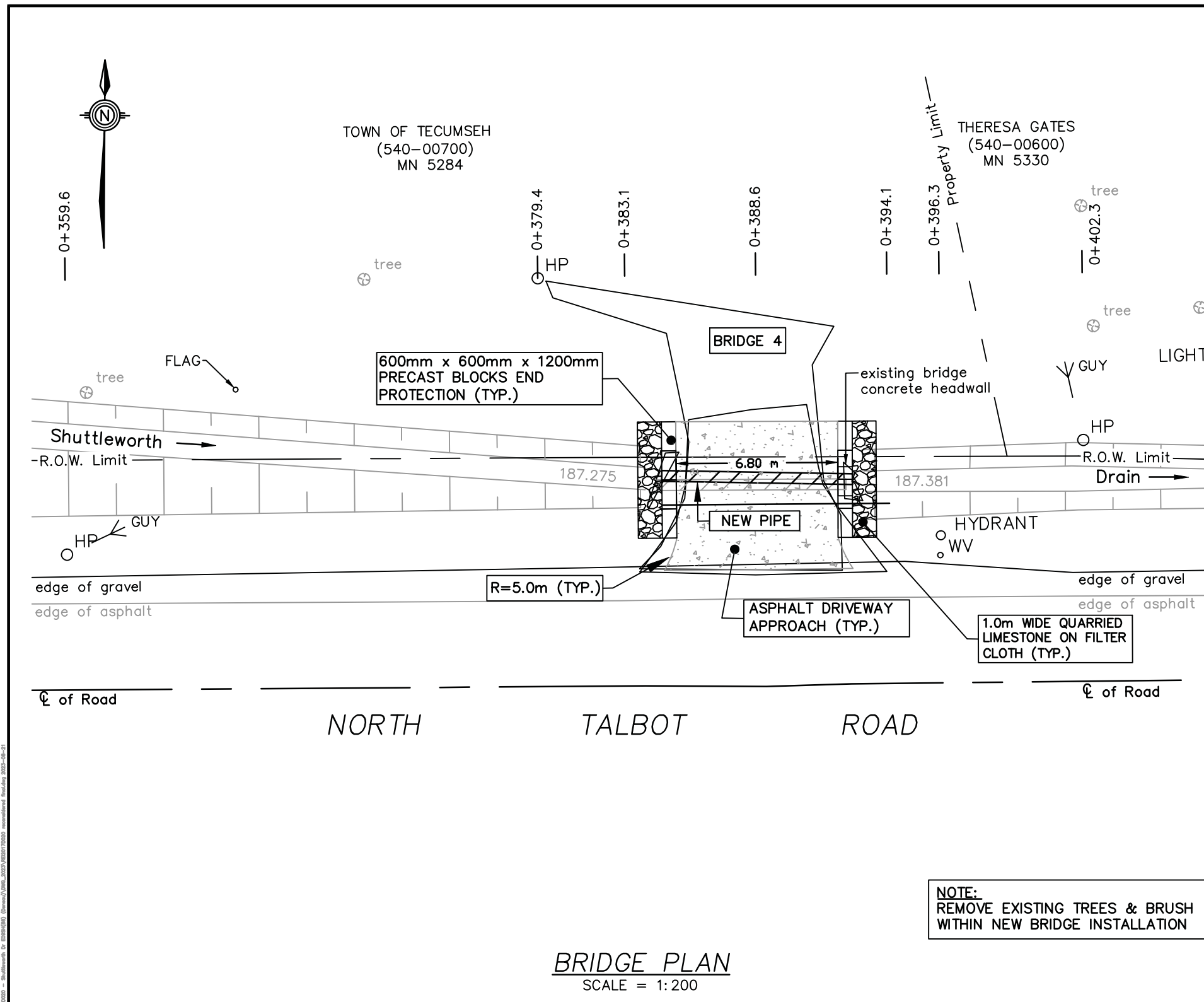

NOTE:
REMOVE EXISTING TREES & BRUSH WITHIN NEW BRIDGE INSTALLATION

BENCHMARK:
TOP NUT OF FIRE HYDRANT LOCATED APPROX. 17.5 METRES EAST OF THE EAST END OF PROPOSED BRIDGE FRONTING MN 5074 ON THE NORTH SIDE OF NORTH TALBOT ROAD
ELEV. = 188.722m

PIPE SIZE:	PIPE LENGTH:	PIPE GAUGE:	CORRUGATIONS:	TYPE OF PIPE:	DESIGN ELEVATIONS:
450mm ϕ	8.0m (26.25 FT.)	320 kPa	STANDARD	SMOOTH WALL H.D.P.E. PIPE	UPSTREAM INV. (W) = 186.816m DOWNSTREAM INV. (E) = 186.804m ϕ TOP OF DRIVEWAY = 187.983m DRAIN GRADE = 0.16%

SHUTTLEWORTH DRAIN
BRIDGE FOR TOWN OF TECUMSEH (540-00700) (EAST ENTRANCE) (GEOGRAPHIC TOWNSHIP OF SANDWICH SOUTH) IN THE TOWN OF TECUMSEH IN THE COUNTY OF ESSEX • ONTARIO

ROOD ENGINEERING INC.
CONSULTING ENGINEERS
Leamington, Ontario
519-322-1621

DATE: 2023-08-21

FILE No.: 2017D020	DRAWN BY: K.D. PLOT CODE: 1:1 FILE: REI2017D020.DWG	APPENDIX 'E' 6 OF 17
-----------------------	---	-------------------------

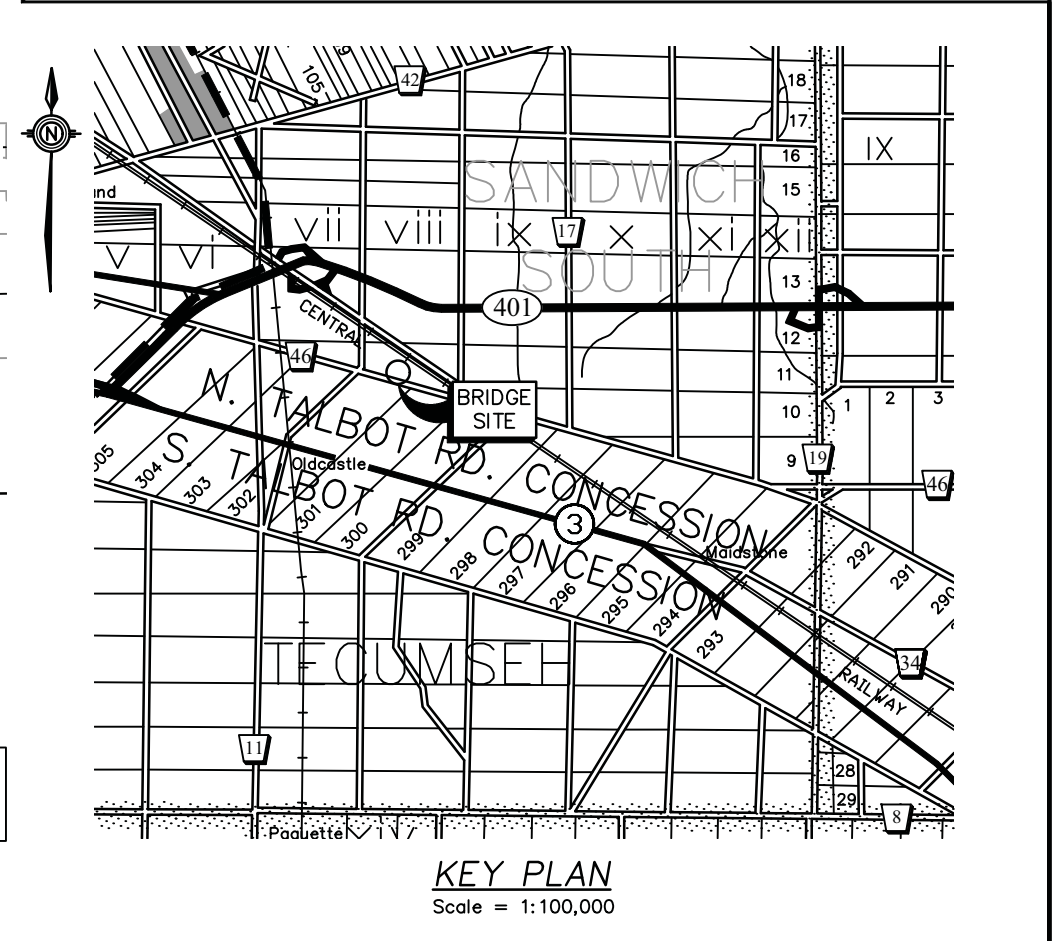
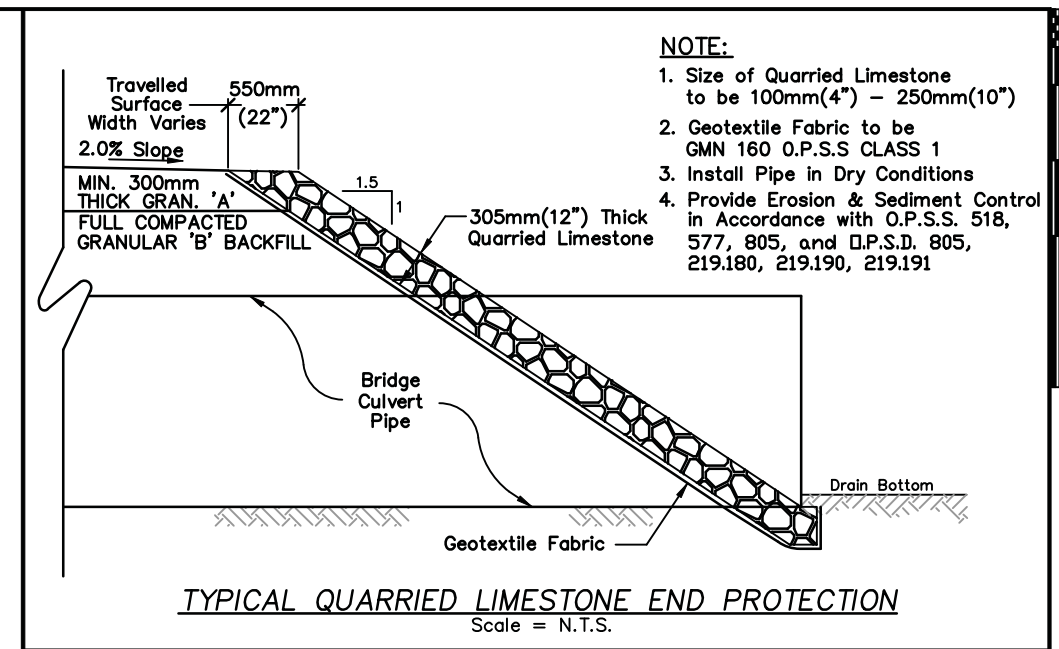
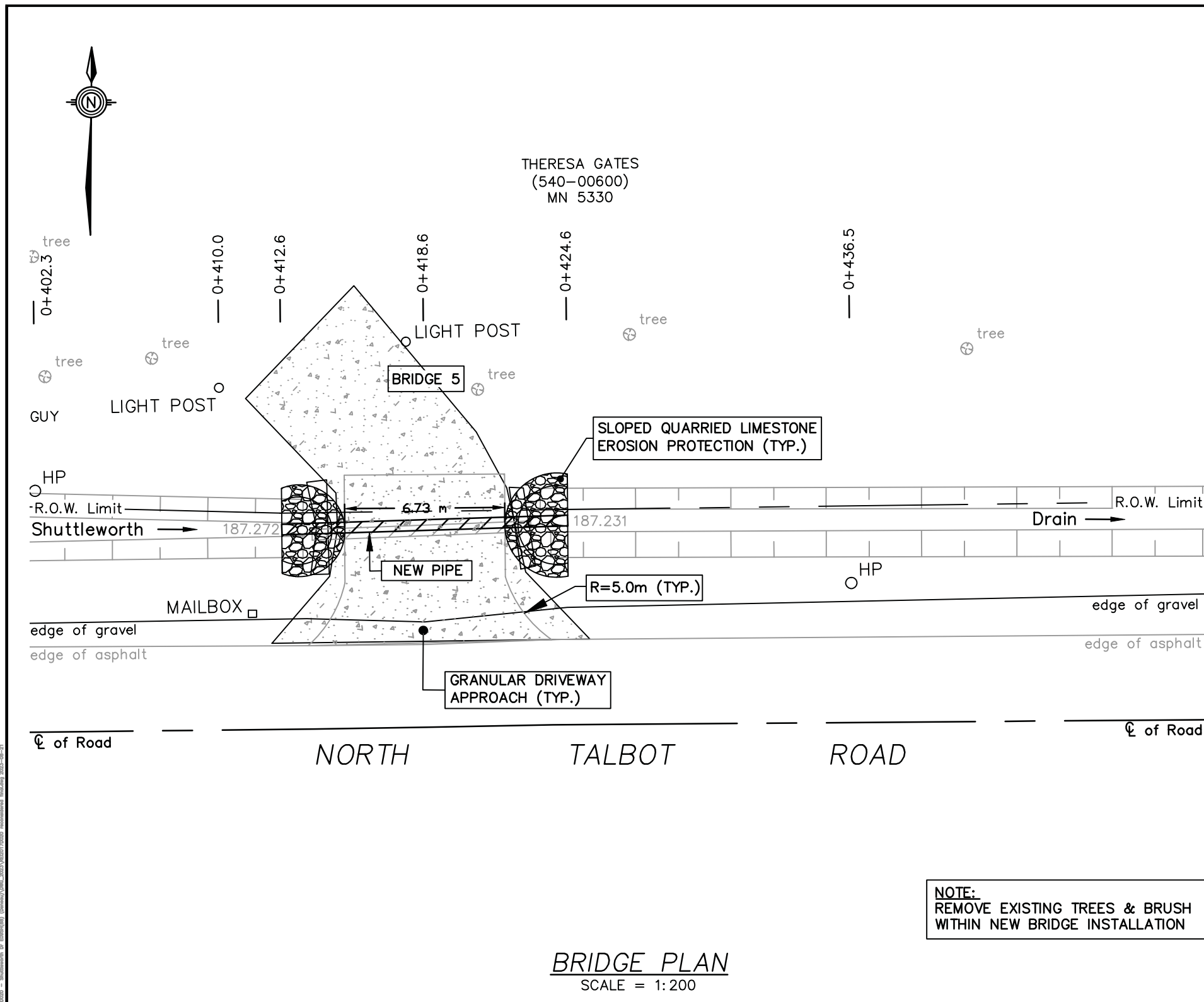

NOTE:
REMOVE EXISTING TREES & BRUSH
WITHIN NEW BRIDGE INSTALLATION

BENCHMARK:
TOP NUT OF FIRE HYDRANT ON NORTH SIDE OF NORTH
TALBOT ROAD DIRECTLY IN FRONT OF MUNICIPAL NUMBER
(M.N.) 5410
ELEV. = 188.632m

PIPE SIZE:	PIPE LENGTH:	PIPE GAUGE:	CORRUGATIONS:	TYPE OF PIPE:	DESIGN ELEVATIONS:
450mm ϕ	12.0m (39.37 FT.)	320 kPa	STANDARD	SMOOTH WALL H.D.P.E. PIPE	UPSTREAM INV. (W) = 186.772m DOWNSTREAM INV. (E) = 186.752m ϕ TOP OF DRIVEWAY = 188.142m DRAIN GRADE = 0.16%

SHUTTLEWORTH DRAIN
BRIDGE FOR THERESA GATES (540-00600)
(GEOGRAPHIC TOWNSHIP OF SANDWICH SOUTH)
IN THE
TOWN OF TECUMSEH
IN THE
COUNTY OF ESSEX • ONTARIO

ROOD ENGINEERING INC.
CONSULTING ENGINEERS
Leamington, Ontario
519-322-1621

DATE: 2023-08-21

FILE No.: 2017D020	DRAWN BY: K.D. PLOT CODE: 1:1 FILE: REI2017D020.DWG	APPENDIX 'E' 7 OF 17
-----------------------	---	-------------------------

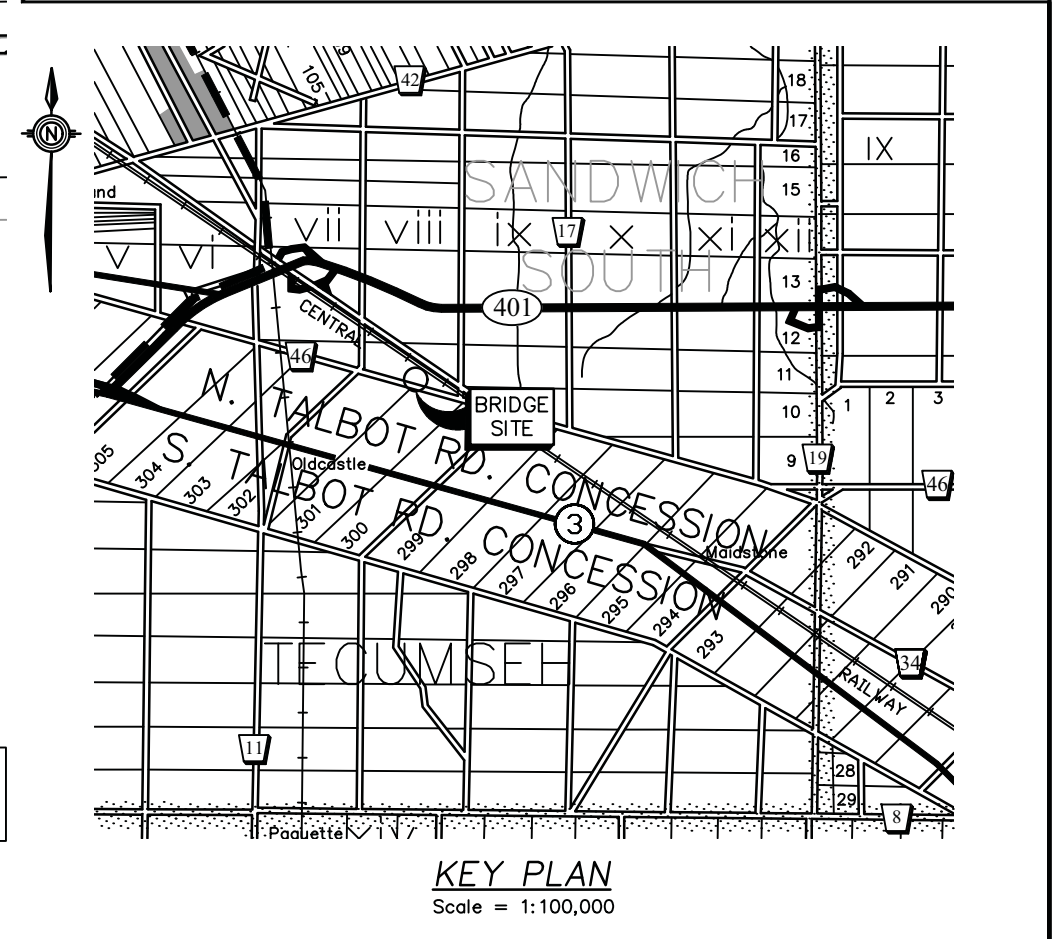
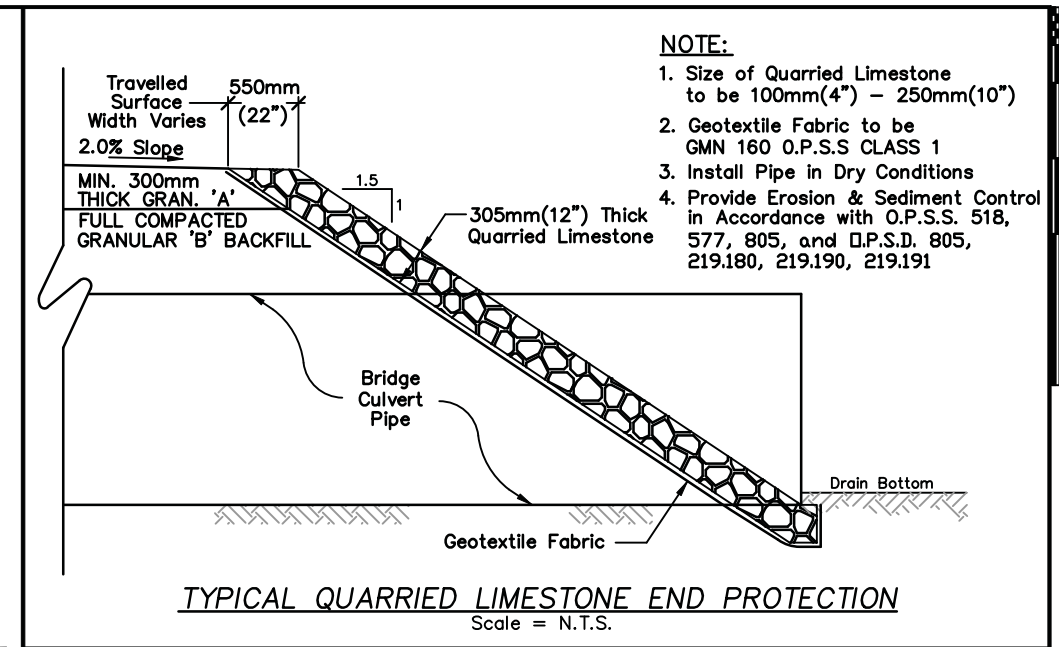
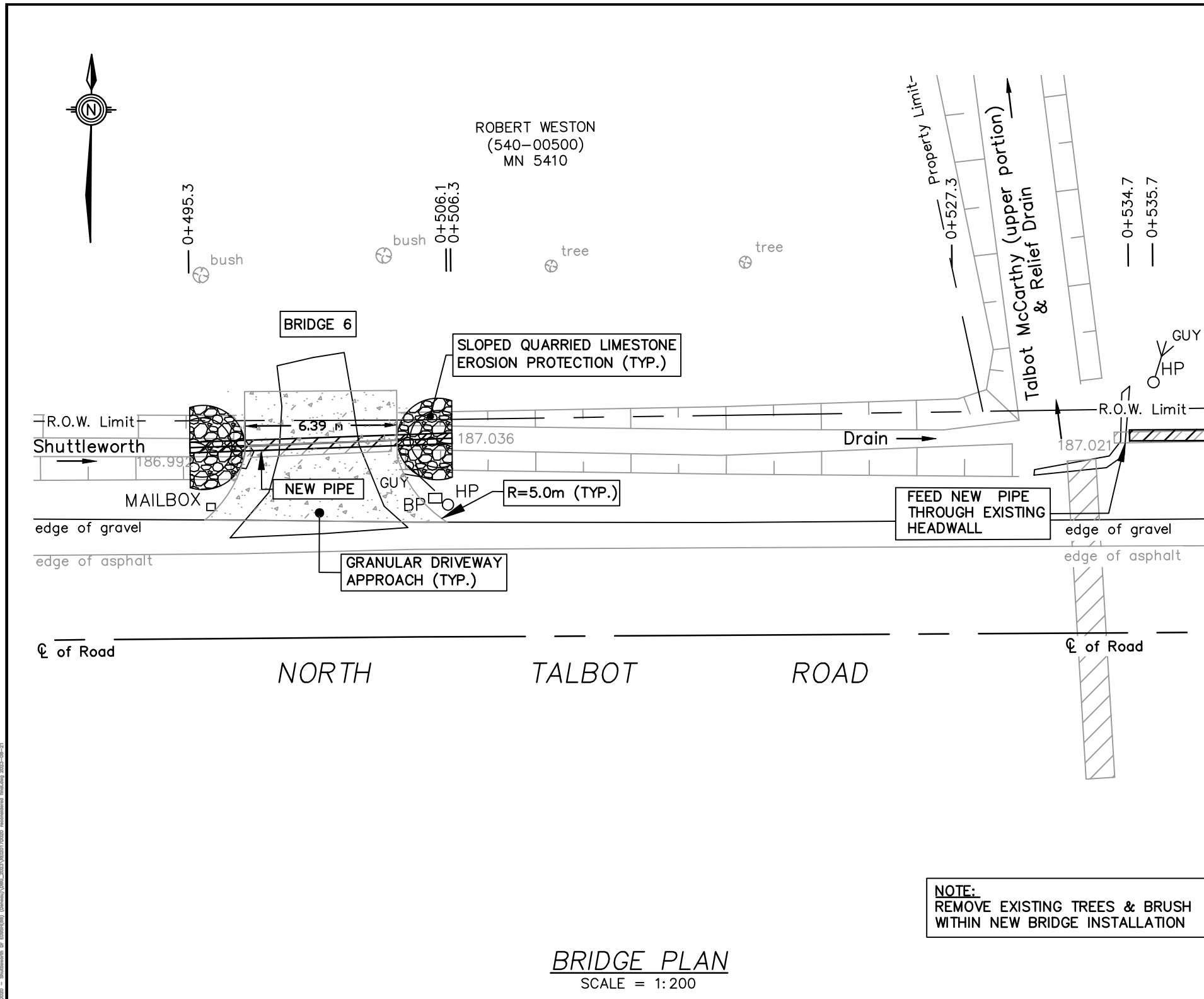

- NOTE:**
1. Size of Quarried Limestone to be 100mm(4") - 250mm(10")
 2. Geotextile Fabric to be GMN 160 O.P.S.S CLASS 1
 3. Install Pipe in Dry Conditions
 4. Provide Erosion & Sediment Control in Accordance with O.P.S.S. 518, 577, 805, and O.P.S.D. 805, 219.180, 219.190, 219.191

NOTE:
REMOVE EXISTING TREES & BRUSH WITHIN NEW BRIDGE INSTALLATION

BENCHMARK:
TOP NUT OF FIRE HYDRANT ON NORTH SIDE OF NORTH TALBOT ROAD DIRECTLY IN FRONT OF MUNICIPAL NUMBER (M.N.) 5410
ELEV. = 188.632m

PIPE SIZE:	PIPE LENGTH:	PIPE GAUGE:	CORRUGATIONS:	TYPE OF PIPE:	DESIGN ELEVATIONS:
450mm ϕ	11.0m (36.09 FT.)	320 kPa	STANDARD	SMOOTH WALL H.D.P.E. PIPE	UPSTREAM INV. (W) = 186.639m DOWNSTREAM INV. (E) = 186.621m ϕ TOP OF DRIVEWAY = 187.792m DRAIN GRADE = 0.16%

SHUTTLEWORTH DRAIN
BRIDGE FOR ROBERT WESTON (540-00500)
(GEOGRAPHIC TOWNSHIP OF SANDWICH SOUTH)
IN THE
TOWN OF TECUMSEH
IN THE
COUNTY OF ESSEX • ONTARIO

ROOD ENGINEERING INC.
CONSULTING ENGINEERS
Leamington, Ontario
519-322-1621

DATE: 2023-08-21

FILE No.: 2017D020	DRAWN BY: K.D. PLOT CODE: 1:1 FILE: REI2017D020.DWG	APPENDIX 'E' 8 OF 17
-----------------------	---	-------------------------

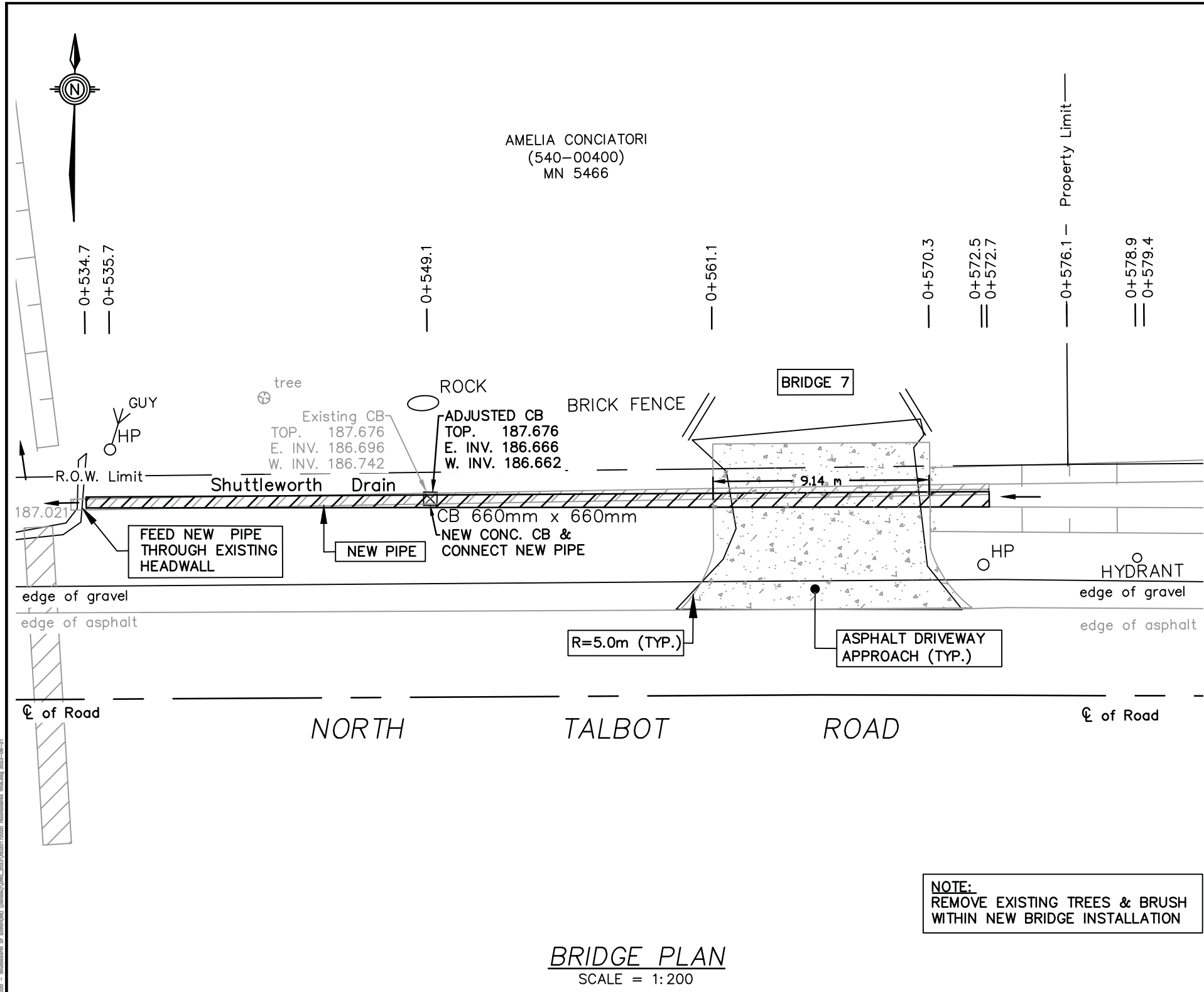

BRIDGE PLAN
SCALE = 1:200

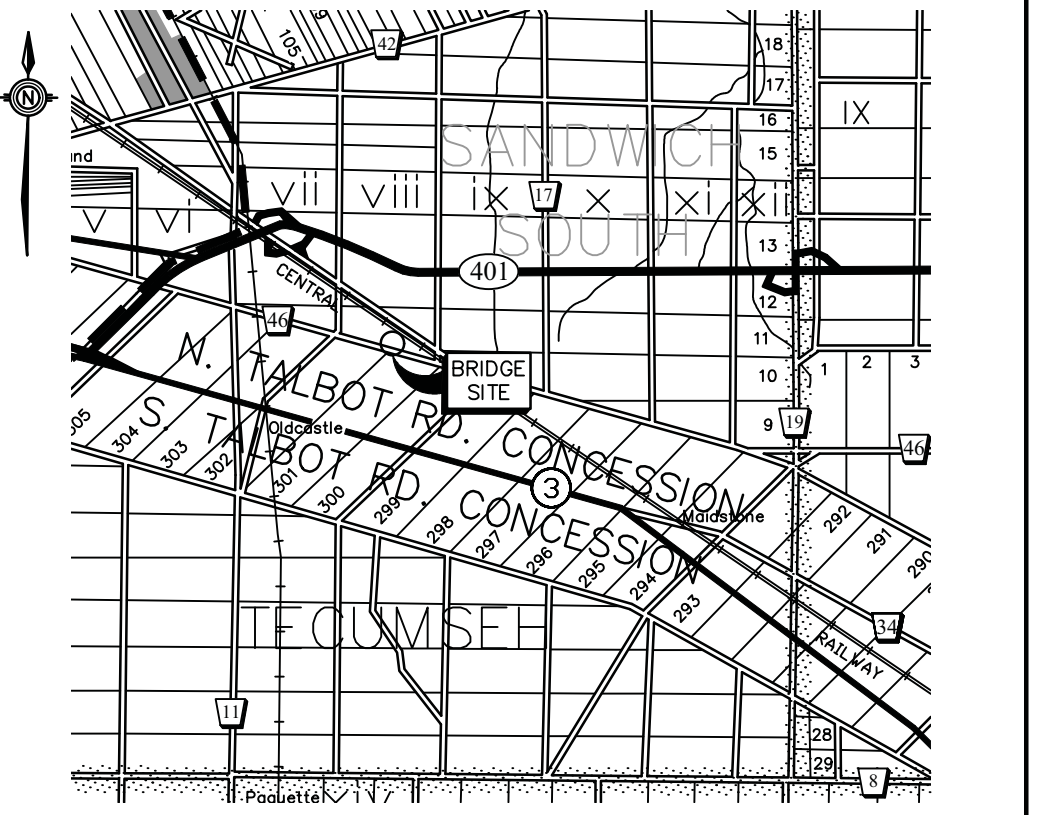
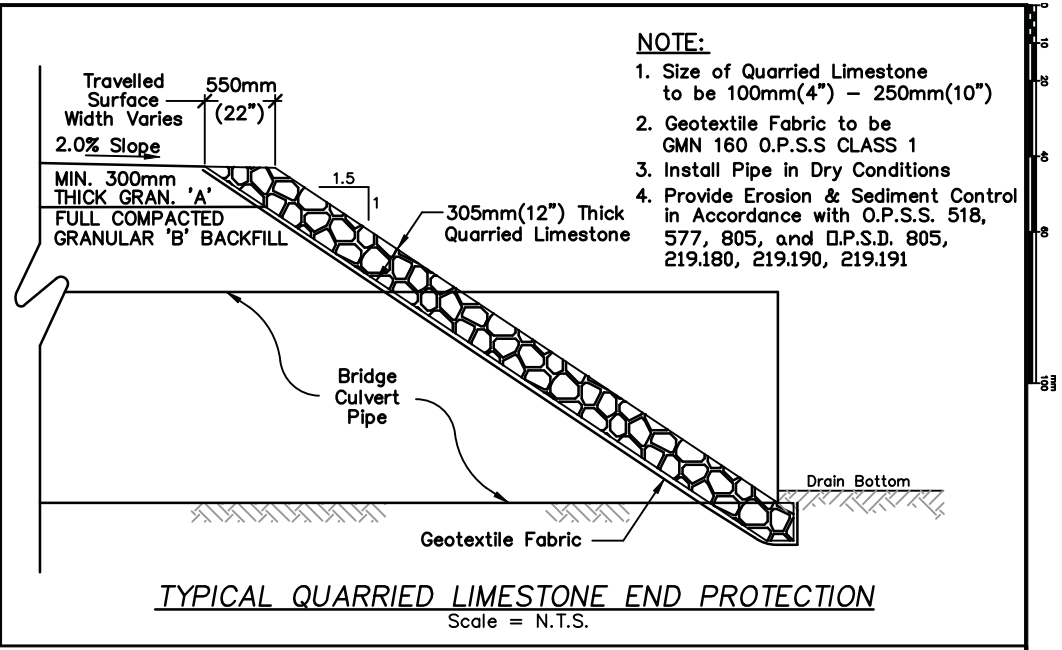

NOTE:
REMOVE EXISTING TREES & BRUSH
WITHIN NEW BRIDGE INSTALLATION

BENCHMARK:
TOP NUT OF FIRE HYDRANT ON NORTH SIDE OF NORTH TALBOT ROAD DIRECTLY IN FRONT OF MUNICIPAL NUMBER (M.N.) 5410
ELEV. = 188.632m

PIPE SIZE:	PIPE LENGTH:	PIPE GAUGE:	CORRUGATIONS:	TYPE OF PIPE:	DESIGN ELEVATIONS:
450mm ϕ	38.0m (124.7 FT.)	320 kPa	STANDARD	SMOOTH WALL H.D.P.E. PIPE	UPSTREAM INV. (E) = 186.792m DOWNSTREAM INV. (W) = 186.588m ⊘ TOP OF DRIVEWAY = 187.925m DRAIN GRADE = 0.53%

SHUTTLEWORTH DRAIN
BRIDGE ENCLOSURE FOR AMELIA CONCIATORI (540-00400)
(GEOGRAPHIC TOWNSHIP OF SANDWICH SOUTH)
IN THE
TOWN OF TECUMSEH
IN THE
COUNTY OF ESSEX • ONTARIO

ROOD ENGINEERING INC.
CONSULTING ENGINEERS
Leamington, Ontario
519-322-1621

DATE: 2023-08-21

FILE No.: 2017D020	DRAWN BY: K.D. PLOT CODE: 1:1 FILE: REI2017D020.DWG	APPENDIX 'E' 9 OF 17
-----------------------	---	-------------------------

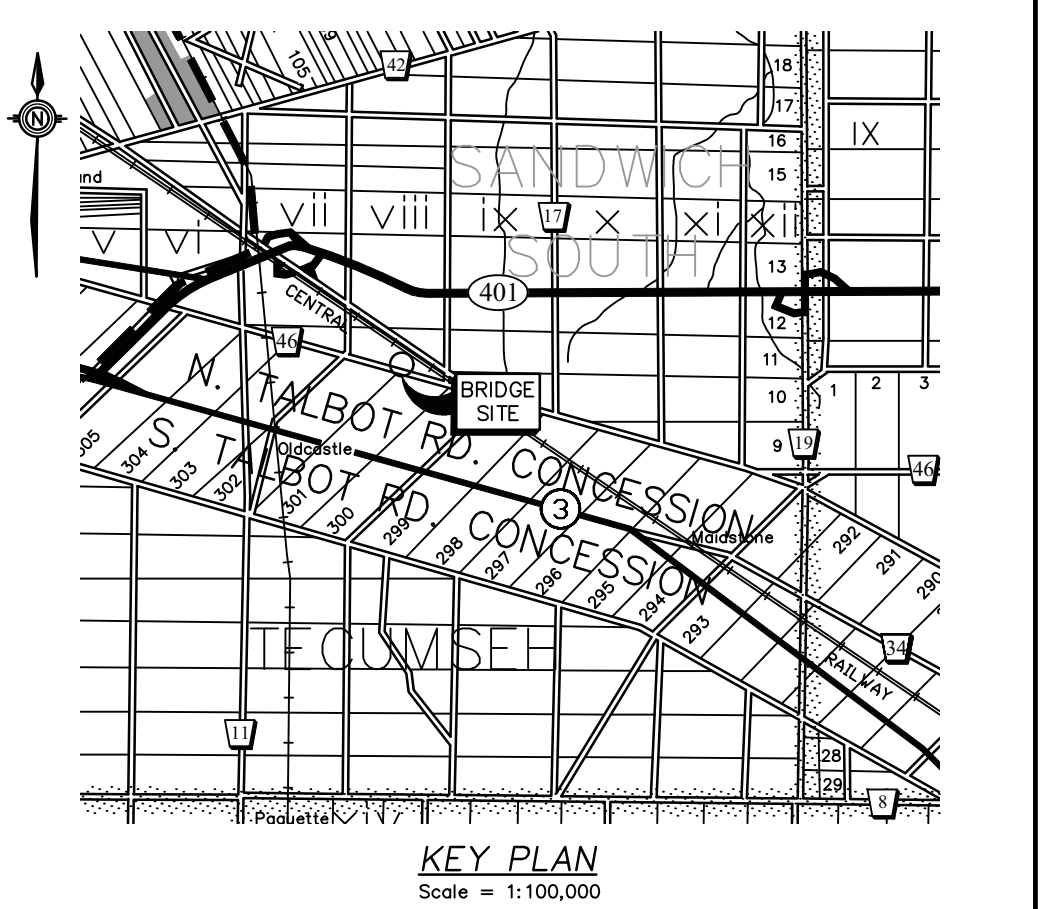
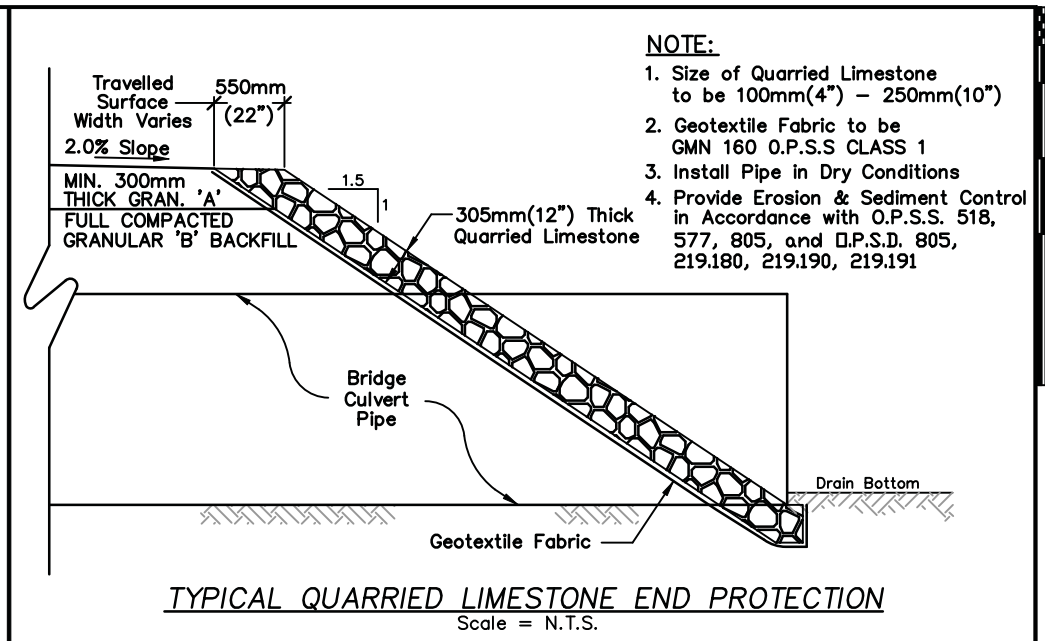
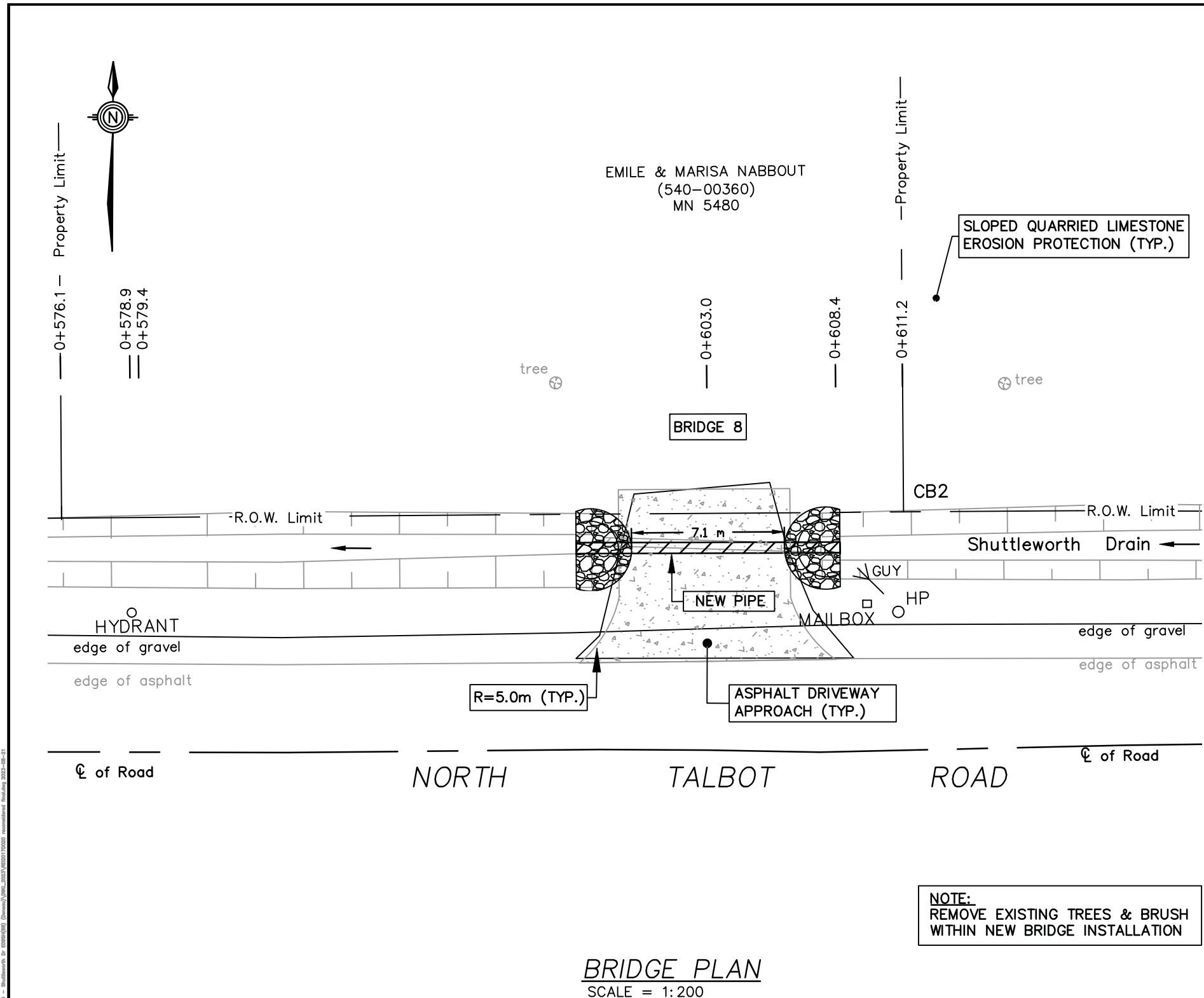

BENCHMARK:
TOP NUT OF FIRE HYDRANT ON NORTH SIDE OF NORTH TALBOT ROAD ACROSS THE ROAD OF MUNICIPAL NUMBER (M.N.) 5475 AND IN FRONT OF M.N 5480
ELEV. = 188.673m

PIPE SIZE:	PIPE LENGTH:	PIPE GAUGE:	CORRUGATIONS:	TYPE OF PIPE:	DESIGN ELEVATIONS:
450mm ϕ	12m (39.4 FT.)	320 kPa	STANDARD	SMOOTH WALL H.D.P.E. PIPE	UPSTREAM INV. (E) = 186.977m DOWNSTREAM INV. (W) = 186.913m ¢ TOP OF DRIVEWAY = 187.900m DRAIN GRADE = 0.53%

SHUTTLEWORTH DRAIN
BRIDGE ENCLOSURE FOR EMILE & MARISA NABBOUT (540-00360)
(GEOGRAPHIC TOWNSHIP OF SANDWICH SOUTH)
IN THE
TOWN OF TECUMSEH
IN THE
COUNTY OF ESSEX • ONTARIO

ROOD ENGINEERING INC.
CONSULTING ENGINEERS
Leamington, Ontario
519-322-1621

DATE: 2023-08-21

FILE No.: 2017D020	DRAWN BY: K.D. PLOT CODE: 1:1 FILE: REI2017D020.DWG	APPENDIX 'E' 10 OF 17
--------------------	---	--------------------------

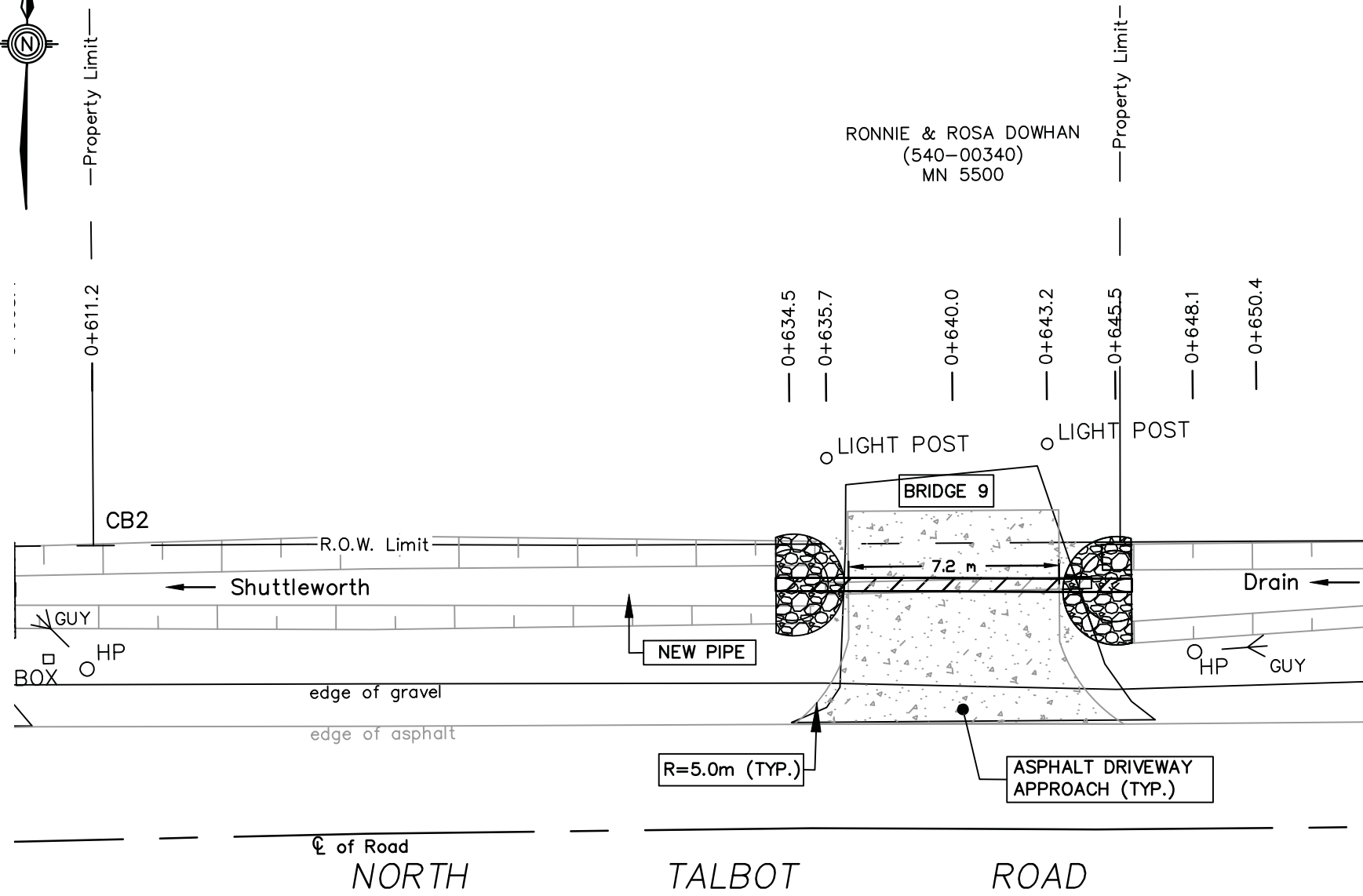

BRIDGE PLAN
SCALE = 1:200

NOTE:
REMOVE EXISTING TREES & BRUSH
WITHIN NEW BRIDGE INSTALLATION

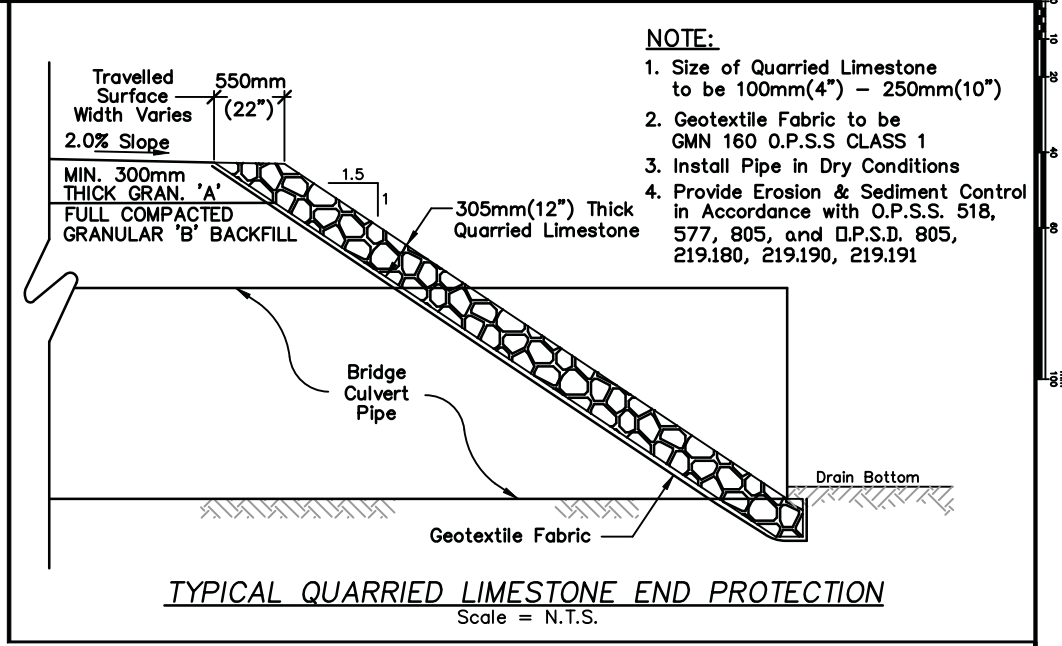

TYPICAL QUARRIED LIMESTONE END PROTECTION
Scale = N.T.S.

- NOTE:**
1. Size of Quarried Limestone to be 100mm(4") - 250mm(10")
 2. Geotextile Fabric to be GMN 160 O.P.S.S CLASS 1
 3. Install Pipe in Dry Conditions
 4. Provide Erosion & Sediment Control in Accordance with O.P.S.S. 518, 577, 805, and O.P.S.D. 805, 219.180, 219.190, 219.191

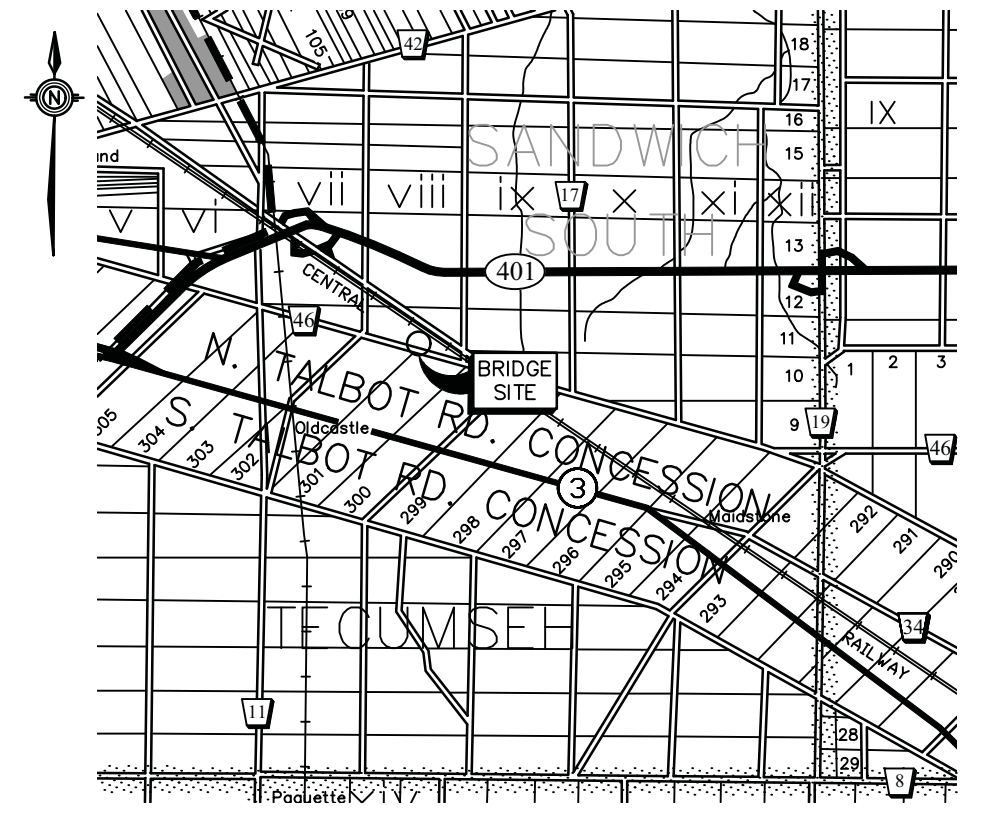

KEY PLAN
Scale = 1:100,000

BENCHMARK:
TOP NUT OF FIRE HYDRANT ON NORTH SIDE OF NORTH
TALBOT ROAD ACROSS THE ROAD OF MUNICIPAL NUMBER
(M.N.) 5475 AND IN FRONT OF M.N 5480
ELEV. = 188.673m

PIPE SIZE:	PIPE LENGTH:	PIPE GAUGE:	CORRUGATIONS:	TYPE OF PIPE:	DESIGN ELEVATIONS:
450mm ϕ	12.0m (39.4 FT.)	320 kPa	STANDARD	SMOOTH WALL H.D.P.E. PIPE	UPSTREAM INV. (E) = 187.174m DOWNSTREAM INV. (W) = 187.111m ϕ TOP OF DRIVEWAY = 188.100m DRAIN GRADE = 0.53%

SHUTTLEWORTH DRAIN
BRIDGE FOR RONNIE & ROSA DOWHAN (540-00340)
(GEOGRAPHIC TOWNSHIP OF SANDWICH SOUTH)
IN THE
TOWN OF TECUMSEH
IN THE
COUNTY OF ESSEX • ONTARIO

ROOD ENGINEERING INC.
CONSULTING ENGINEERS
Leamington, Ontario
519-322-1621
DATE: 2023-08-21

FILE No.: 2017D020
DRAWN BY: K.D.
PLOT CODE: 1:1
FILE: REI2017D020.DWG
APPENDIX 'E'
11 OF 17

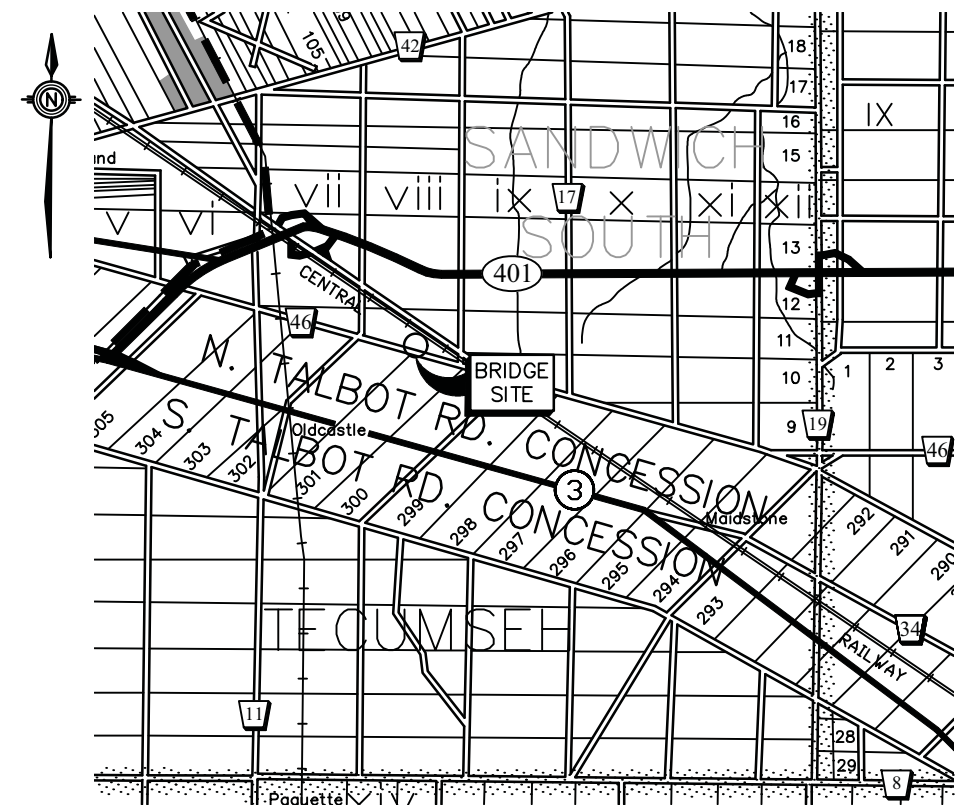
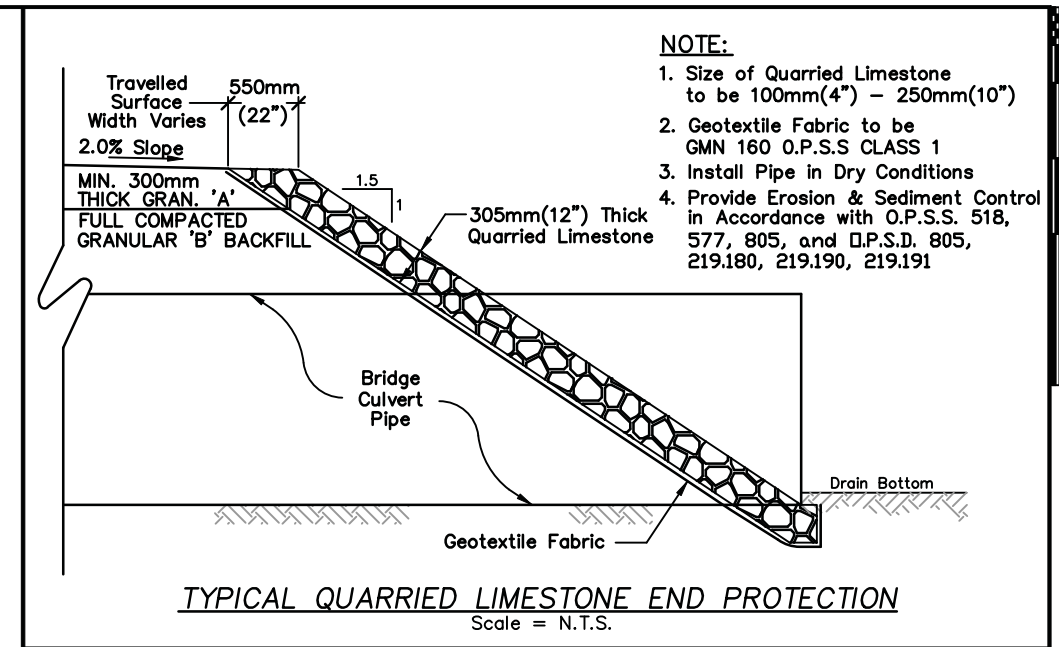
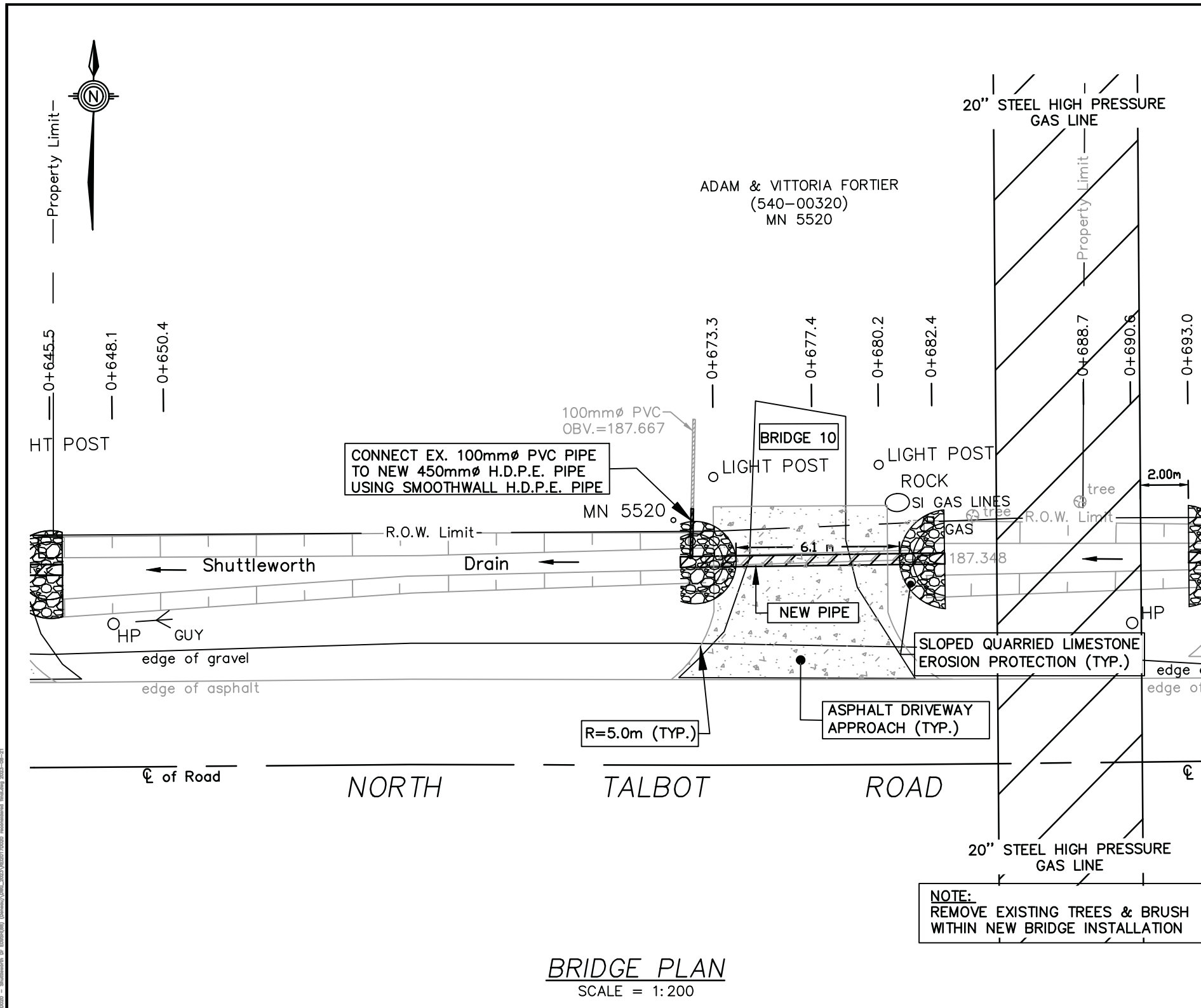

BRIDGE PLAN
SCALE = 1:200

BENCHMARK:
TOP NUT OF FIRE HYDRANT ON NORTH SIDE OF NORTH TALBOT ROAD ACROSS THE ROAD OF MUNICIPAL NUMBER (M.N.) 5475 AND IN FRONT OF M.N 5480
ELEV. = 188.673m

PIPE SIZE:	PIPE LENGTH:	PIPE GAUGE:	CORRUGATIONS:	TYPE OF PIPE:	DESIGN ELEVATIONS:
450mm ϕ	11.0m (36.0 FT.)	320 kPa	STANDARD	SMOOTH WALL H.D.P.E. PIPE	UPSTREAM INV. (E) = 187.369m DOWNSTREAM INV. (W) = 187.310m ϕ TOP OF DRIVEWAY = 188.250m DRAIN GRADE = 0.53%

SHUTTLEWORTH DRAIN
BRIDGE ENCLOSURE FOR ADAM & VITTORIA FORTIER (540-00320)
(GEOGRAPHIC TOWNSHIP OF SANDWICH SOUTH)
IN THE
TOWN OF TECUMSEH
IN THE
COUNTY OF ESSEX • ONTARIO

ROOD ENGINEERING INC.
CONSULTING ENGINEERS
Leamington, Ontario
519-322-1621

FILE No.: 2017D020
DRAWN BY: K.D.
PLOT CODE: 1:1
FILE: REI2017D020.DWG

DATE: 2023-08-21
APPENDIX 'E'
12 OF 17

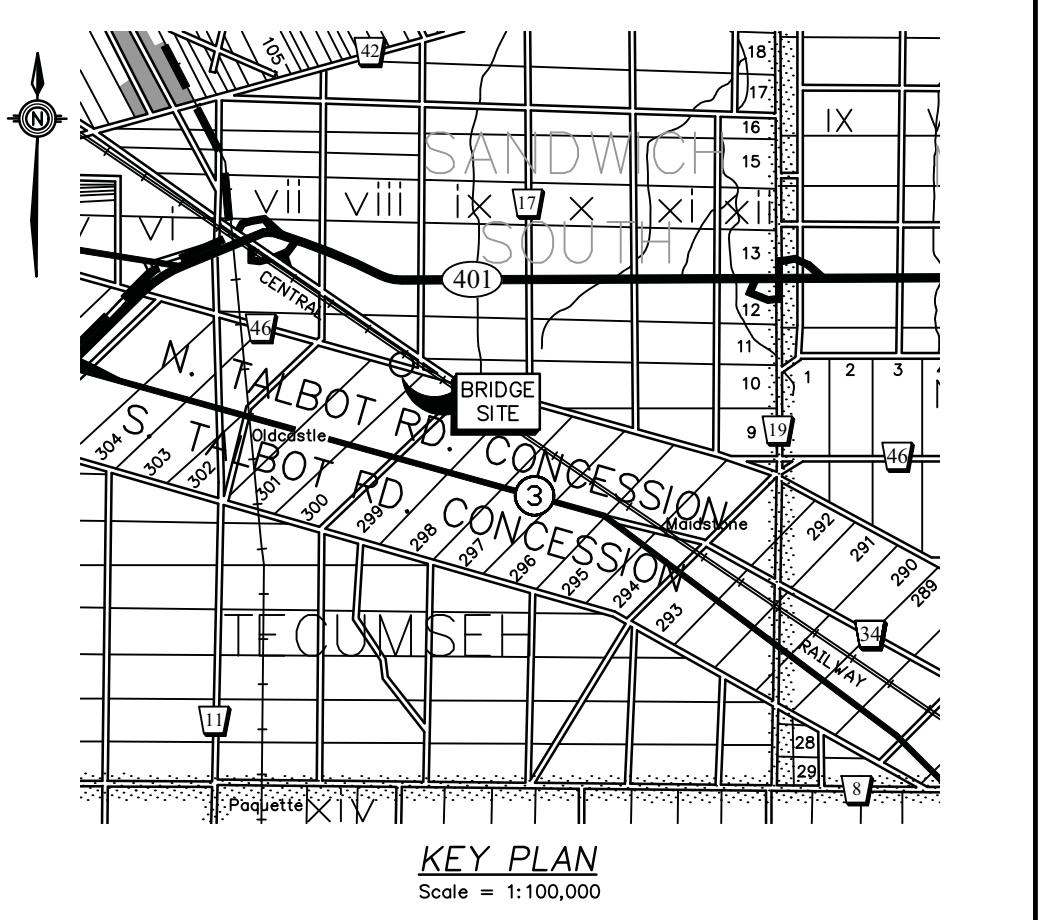
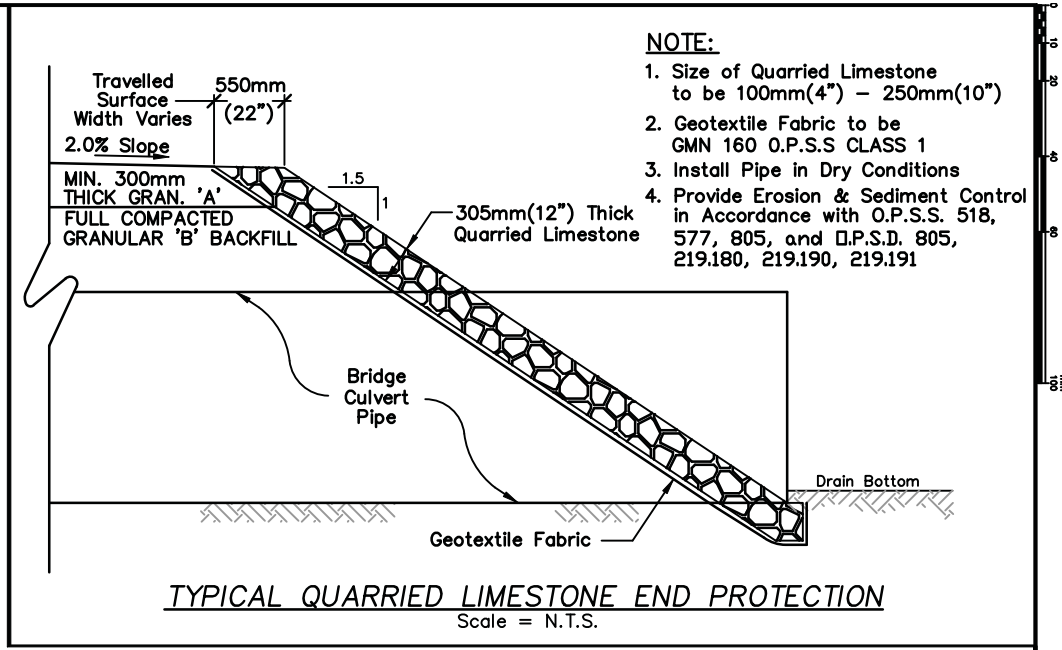
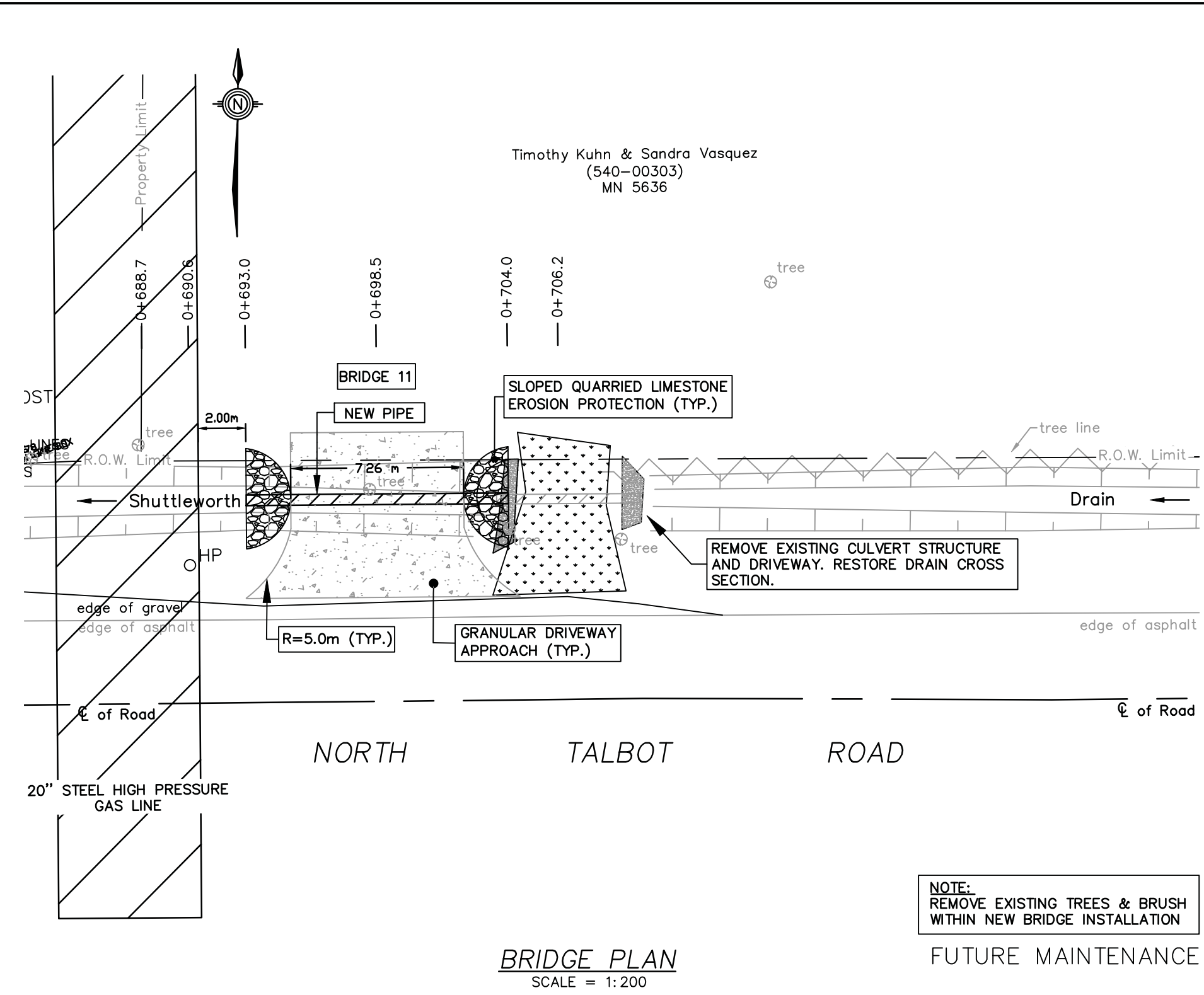

NOTE:
REMOVE EXISTING TREES & BRUSH
WITHIN NEW BRIDGE INSTALLATION

FUTURE MAINTENANCE

BENCHMARK:
TOP NUT OF FIRE HYDRANT ON NORTH SIDE OF NORTH
TALBOT ROAD ACROSS THE ROAD OF MUNICIPAL NUMBER
(M.N.) 5475 AND IN FRONT OF M.N 5480
ELEV. = 188.673m

PIPE SIZE:	PIPE LENGTH:	PIPE GAUGE:	CORRUGATIONS:	TYPE OF PIPE:	DESIGN ELEVATIONS:
450mm ϕ	11.0m (36.09 FT.)	320 kPa	STANDARD	SMOOTH WALL H.D.P.E. PIPE	UPSTREAM INV. (E) = 187.479m DOWNSTREAM INV. (W) = 187.421m ϕ TOP OF DRIVEWAY = 188.400m DRAIN GRADE = 0.53%

SHUTTLEWORTH DRAIN
BRIDGE FOR TIMOTHY KUHN & SANDRA VASQUEZ (540-003??)
(GEOGRAPHIC TOWNSHIP OF SANDWICH SOUTH)
IN THE
TOWN OF TECUMSEH
IN THE
COUNTY OF ESSEX • ONTARIO

**ROOD
ENGINEERING
INC.**
CONSULTING ENGINEERS
Leamington, Ontario
519-322-1621

FILE No.: 2017D020	DRAWN BY: K.D. PLOT CODE: 1:1 FILE: REI2017D020.DWG	DATE: 2023-08-21
		APPENDIX 'E' 13 OF 17



JOHN WHITE
(540-00301)
MN 5648

0+746.9

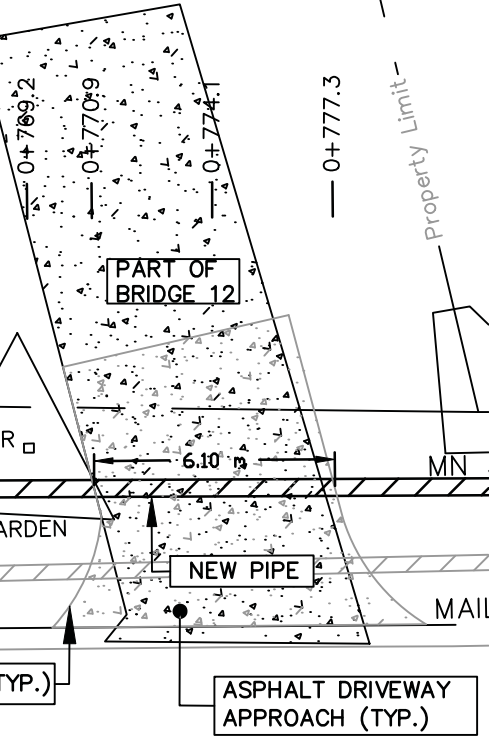

NORTH TALBOT ROAD

BRIDGE PLAN
SCALE = 1:200

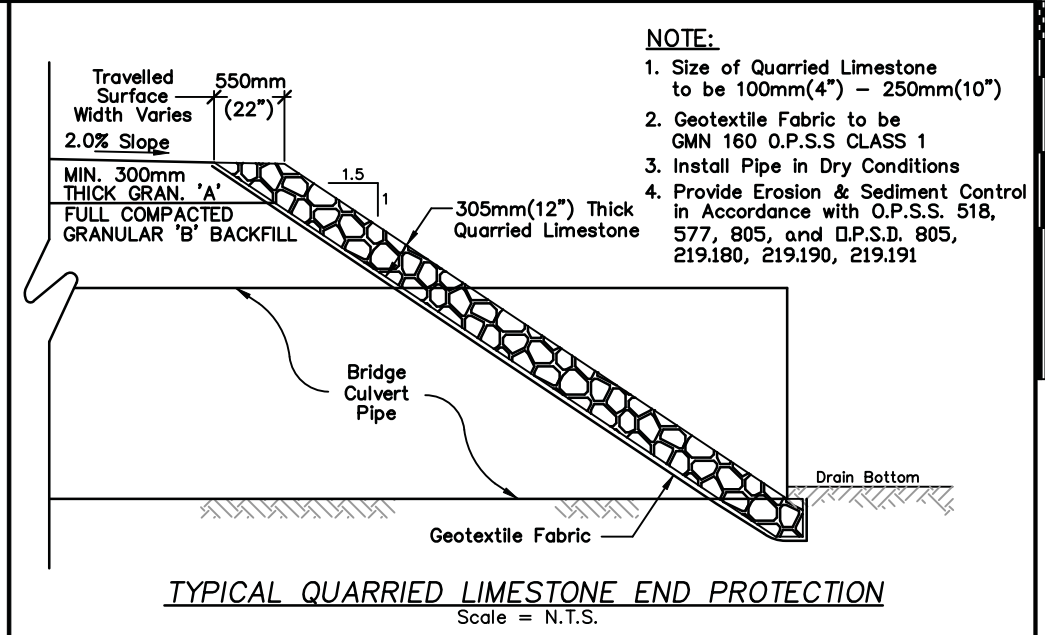

- NOTE:**
1. Size of Quarried Limestone to be 100mm(4") - 250mm(10")
 2. Geotextile Fabric to be GMN 160 O.P.S.S CLASS 1
 3. Install Pipe in Dry Conditions
 4. Provide Erosion & Sediment Control in Accordance with O.P.S.S. 518, 577, 805, and O.P.S.D. 805, 219.180, 219.190, 219.191

TYPICAL QUARRIED LIMESTONE END PROTECTION
Scale = N.T.S.

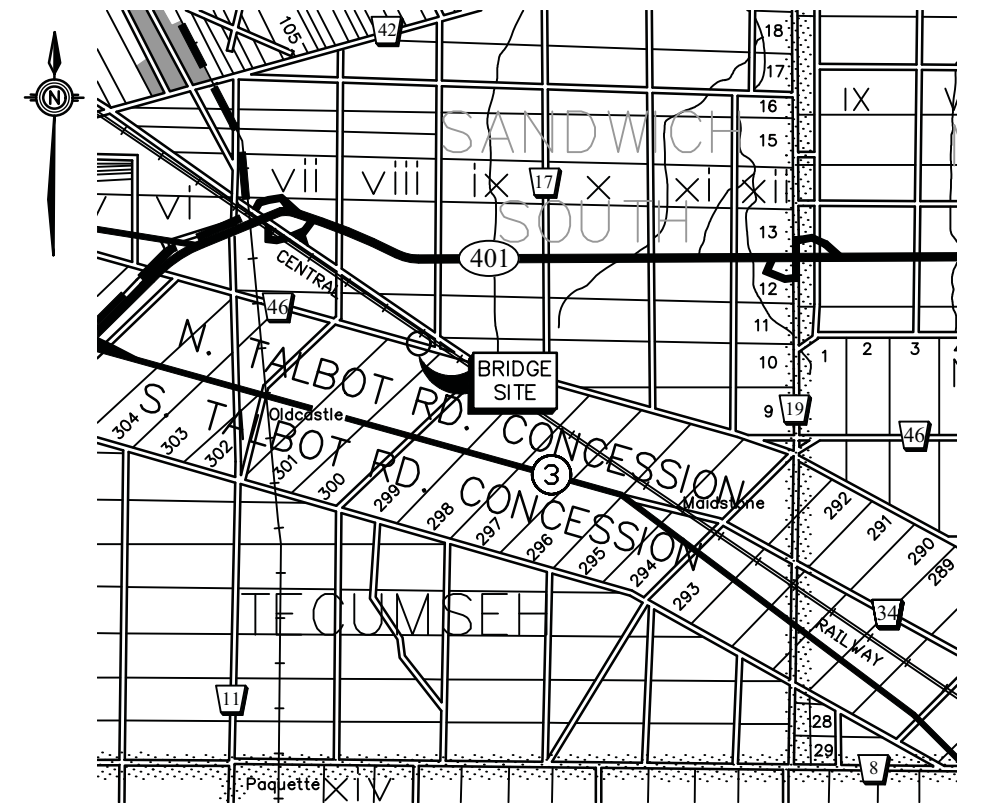

KEY PLAN
Scale = 1:100,000

NOTE:
REMOVE EXISTING TREES & BRUSH WITHIN NEW BRIDGE INSTALLATION

BENCHMARK:
TOP NUT OF FIRE HYDRANT ON NORTH SIDE OF NORTH TALBOT ROAD ACROSS THE ROAD OF MUNICIPAL NUMBER (M.N.) 5475 AND IN FRONT OF M.N 5480
ELEV. = 188.673m

SHUTTLEWORTH DRAIN
BRIDGE FOR JOHN WHITE (540-00301) (EAST BRIDGE ENCLOSURE) (GEOGRAPHIC TOWNSHIP OF SANDWICH SOUTH) IN THE TOWN OF TECUMSEH IN THE COUNTY OF ESSEX • ONTARIO

PIPE SIZE:	PIPE LENGTH:	PIPE GAUGE:	CORRUGATIONS:	TYPE OF PIPE:	DESIGN ELEVATIONS:
375mm ϕ	144.0m (472.44 FT.)	320 kPa	STANDARD	SMOOTH WALL H.D.P.E. PIPE	UPSTREAM INV. (W) = 187.710m DOWNSTREAM INV. (E) = 186.861m ϕ TOP OF DRIVEWAY = 188.267m DRAIN GRADE = 0.59%

ROOD ENGINEERING INC.
CONSULTING ENGINEERS
Leamington, Ontario
519-322-1621

DATE: 2023-08-21
FILE No.: 2017D020
DRAWN BY: K.D.
PLOT CODE: 1:1
FILE: REI2017D020.DWG
APPENDIX 'E'
14 OF 17

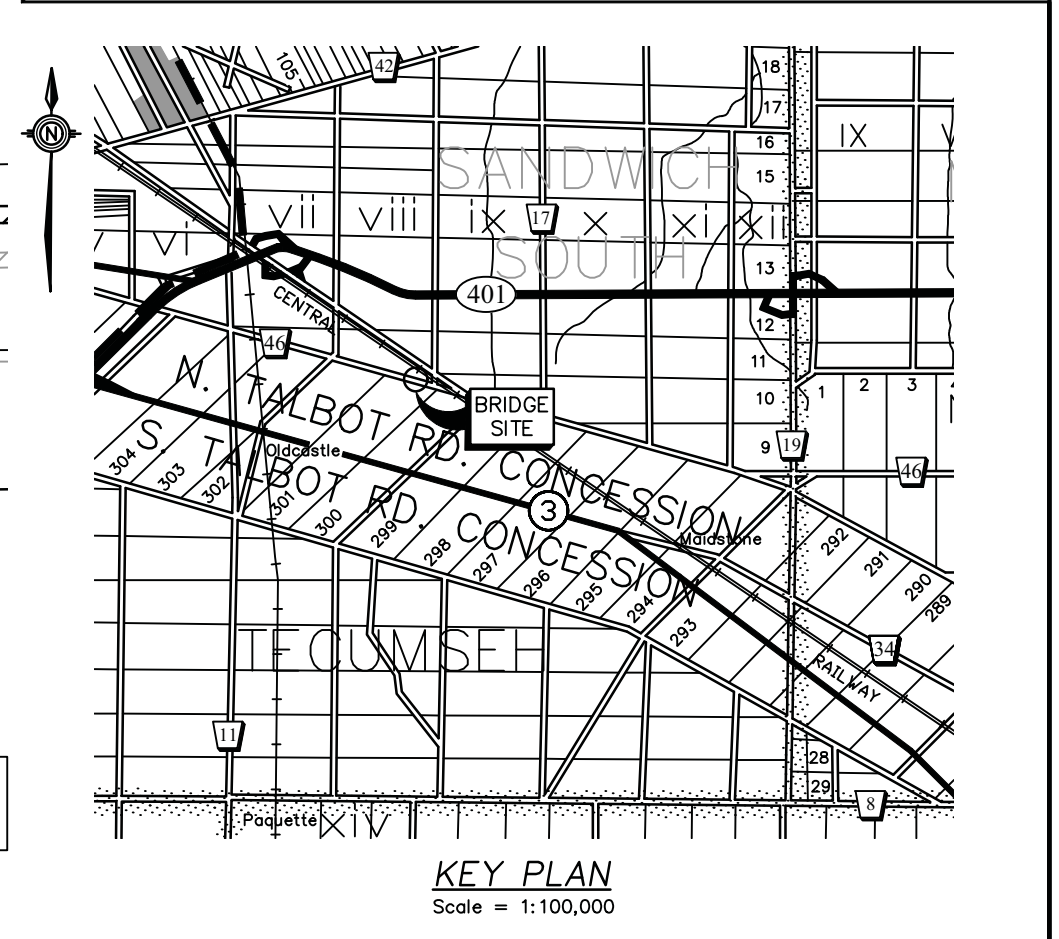
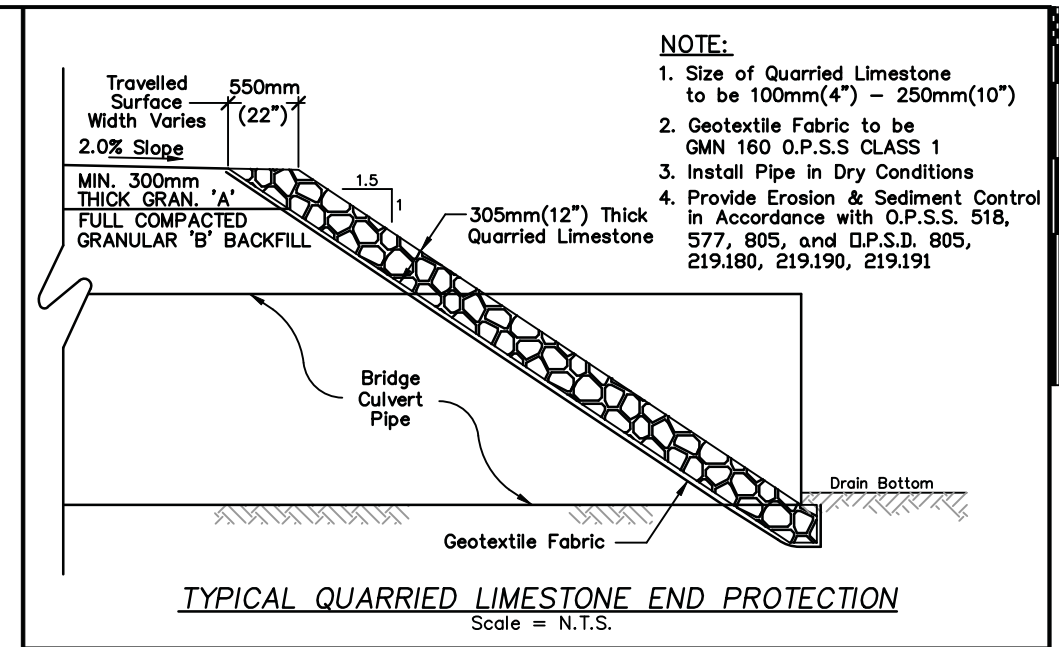
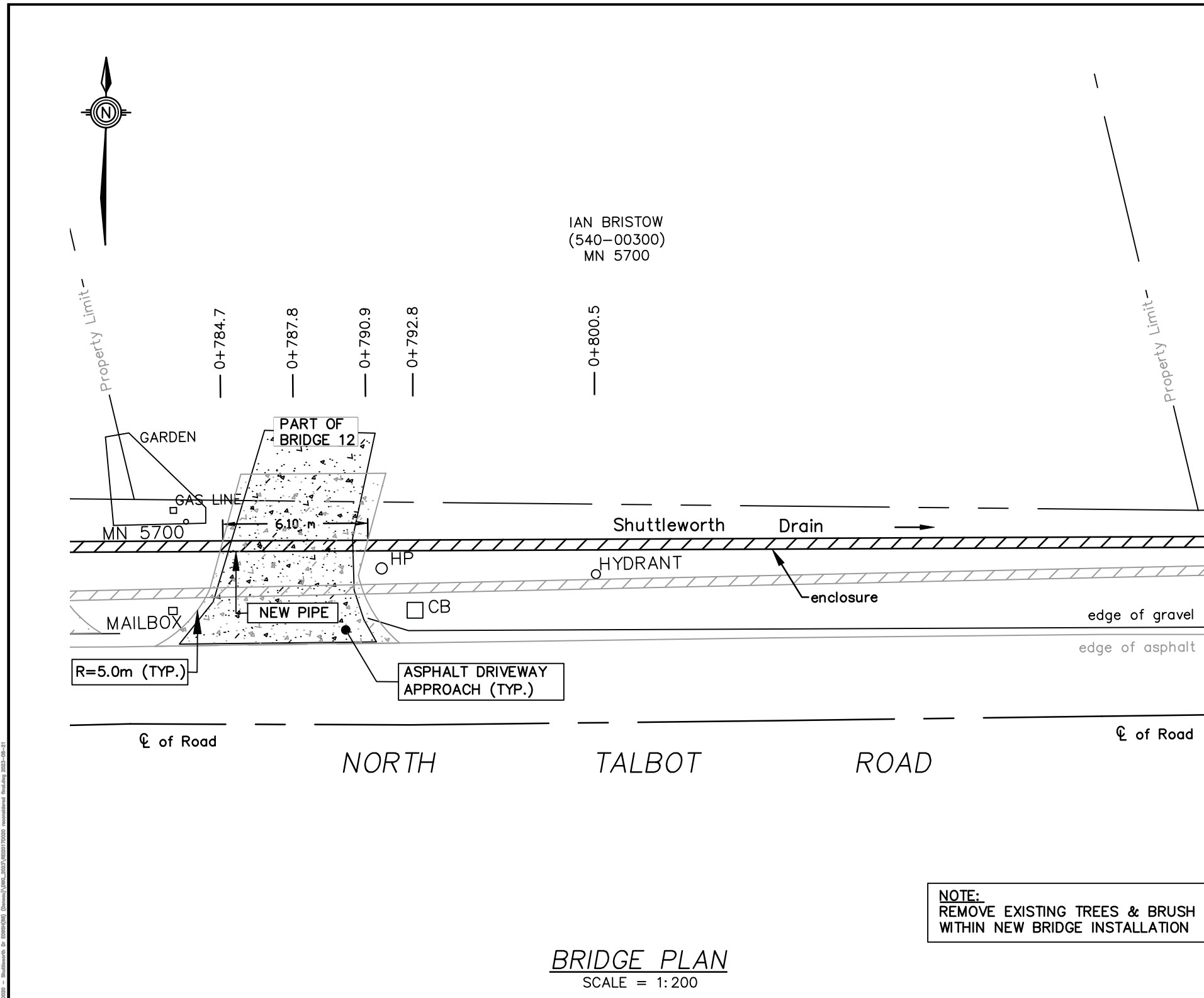

- NOTE:**
1. Size of Quarried Limestone to be 100mm(4") - 250mm(10")
 2. Geotextile Fabric to be GMN 160 O.P.S.S CLASS 1
 3. Install Pipe in Dry Conditions
 4. Provide Erosion & Sediment Control in Accordance with O.P.S.S. 518, 577, 805, and O.P.S.D. 805, 219.180, 219.190, 219.191

NOTE:
REMOVE EXISTING TREES & BRUSH WITHIN NEW BRIDGE INSTALLATION

BENCHMARK:
TOP NUT OF FIRE HYDRANT ON NORTH SIDE OF NORTH TALBOT ROAD ACROSS THE ROAD OF MUNICIPAL NUMBER (M.N.) 5475 AND IN FRONT OF M.N. 5480
ELEV. = 188.673m

SHUTTLEWORTH DRAIN
BRIDGE ENCLOSURE FOR IAN BRISTOW (540-00300)
(GEOGRAPHIC TOWNSHIP OF SANDWICH SOUTH)
IN THE
TOWN OF TECUMSEH
IN THE
COUNTY OF ESSEX • ONTARIO

ROAD ENGINEERING INC.
CONSULTING ENGINEERS
Leamington, Ontario
519-322-1621

PIPE SIZE:	PIPE LENGTH:	PIPE GAUGE:	CORRUGATIONS:	TYPE OF PIPE:	DESIGN ELEVATIONS:
375mm ϕ	144.0m (472.44 FT.)	320 kPa	STANDARD	SMOOTH WALL H.D.P.E. PIPE	UPSTREAM INV. (W) = 187.710m DOWNSTREAM INV. (E) = 186.861m ϕ TOP OF DRIVEWAY = 188.072m DRAIN GRADE = 0.59%

FILE No.: 2017D020	DRAWN BY: K.D. PLOT CODE: 1:1 FILE: REI2017D020.DWG	DATE: 2023-08-21
		APPENDIX 'E' 15 OF 17



THOMAS & DEBRA McGUINNESS
(540-00200)
MN 5760

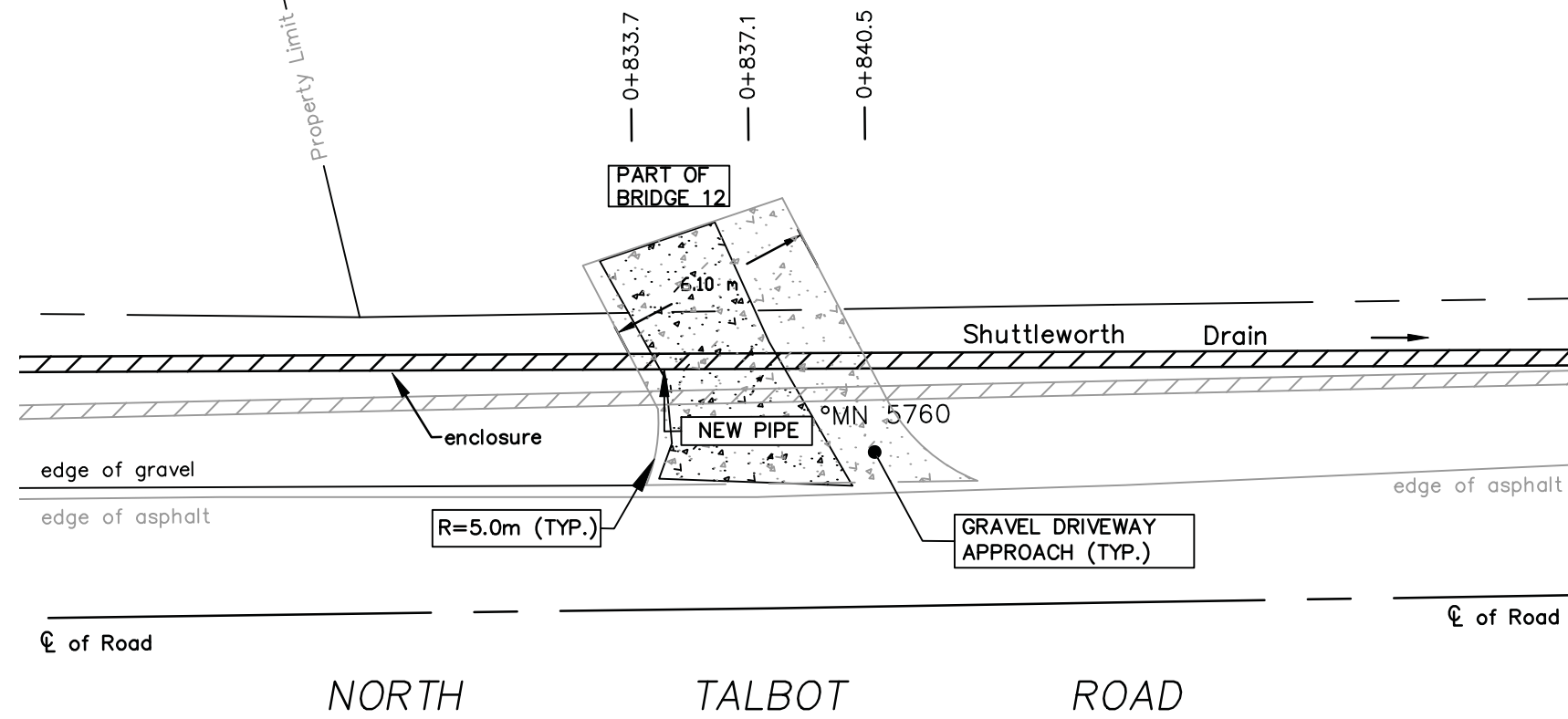

BRIDGE PLAN
SCALE = 1:200

NOTE:
REMOVE EXISTING TREES & BRUSH
WITHIN NEW BRIDGE INSTALLATION

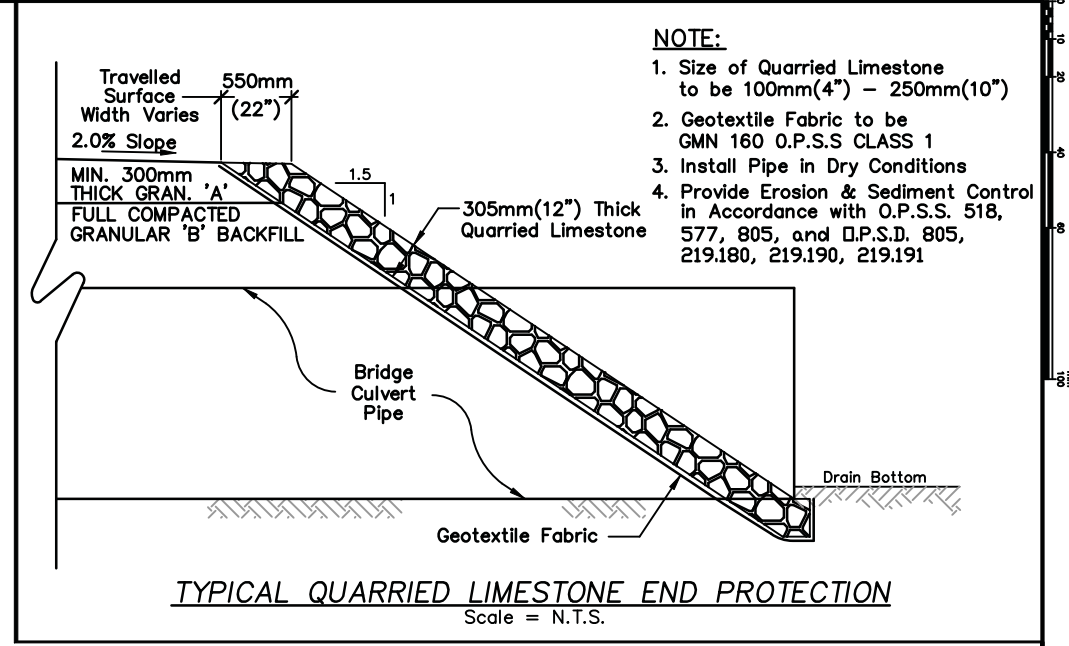

- NOTE:**
1. Size of Quarried Limestone to be 100mm(4") - 250mm(10")
 2. Geotextile Fabric to be GMN 160 O.P.S.S CLASS 1
 3. Install Pipe in Dry Conditions
 4. Provide Erosion & Sediment Control in Accordance with O.P.S.S. 518, 577, 805, and O.P.S.D. 805, 219.180, 219.190, 219.191

TYPICAL QUARRIED LIMESTONE END PROTECTION
Scale = N.T.S.

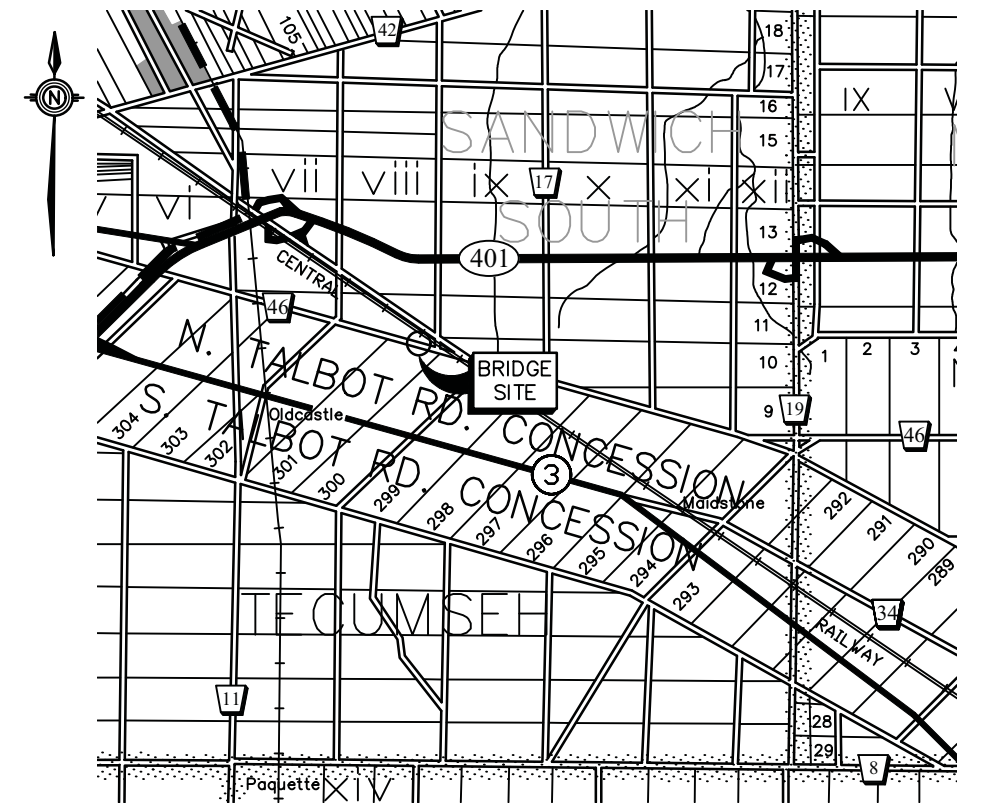

KEY PLAN
Scale = 1:100,000

BENCHMARK:
TOP NUT OF FIRE HYDRANT ON NORTH SIDE OF NORTH
TALBOT ROAD ACROSS THE ROAD OF MUNICIPAL NUMBER
(M.N.) 5475 AND IN FRONT OF M.N 5480
ELEV. = 188.673m

SHUTTLEWORTH DRAIN
BRIDGE ENCLOSURE FOR THOMAS & DEBRA McGUINNESS (540-00200)
(GEOGRAPHIC TOWNSHIP OF SANDWICH SOUTH)
IN THE
TOWN OF TECUMSEH
IN THE
COUNTY OF ESSEX • ONTARIO

PIPE SIZE:	PIPE LENGTH:	PIPE GAUGE:	CORRUGATIONS:	TYPE OF PIPE:	DESIGN ELEVATIONS:
375mm ϕ	144.0m (472.44 FT.)	320 kPa	STANDARD	SMOOTH WALL H.D.P.E. PIPE	UPSTREAM INV. (W) = 187.710m DOWNSTREAM INV. (E) = 186.861m ϕ TOP OF DRIVEWAY = 188.188m DRAIN GRADE = 0.59%

ROOD ENGINEERING INC.
CONSULTING ENGINEERS
Leamington, Ontario
519-322-1621

DATE: 2023-08-21

FILE No.: 2017D020
DRAWN BY: K.D.
PLOT CODE: 1:1
FILE: REI2017D020.DWG

APPENDIX 'E'
16 OF 17

APPENDIX "REI-F"

ROOD ENGINEERING INC.

FINAL SOIL CHARACTERIZATION
REPORT
SHUTTLEWORTH DRAIN

OESAW2232
December 2022





FINAL SOIL CHARACTERIZATION REPORT

SHUTTLEWORTH DRAIN

ROOD ENGINEERING INC.

OESAW2232
DECEMBER 2022

Prepared for:
Rood Engineering Inc.
9 Nelson Street
Leamington, Ontario, N8H 1G6

Prepared by:
WSP E&I Canada Limited
11865 County Road 42
Tecumseh, ON N8N 2M1
Canada
T: 519-735-2499

WSP.com

“Effective September 21, 2022, Wood Environment & Infrastructure Solutions Canada Limited is now operating as WSP E&I Canada Limited. No other aspects of our legal entity, contractual terms or capabilities have changed in relation to this report submission.”



Date: 14 December 2022

Project number: OESAW2232

Mr. Gerard Rood, P.Eng.
Rood Engineering Inc.
9 Nelson Street
Leamington, Ontario, N8H 1G6

Dear Mr. Rood:

**Subject: Final Report – Soil Characterization Report
Shuttleworth Drain
North Side of North Talbot Road, Tecumseh, Ontario**

Please find enclosed one (1) electronic copy, in PDF format, of our final report entitled “Soil Characterization Report, Shuttleworth Drain, North Side of North Talbot Road, Tecumseh, Ontario.”

We thank you for entrusting us with this assignment and look forward to future opportunities with your firm. In the meantime, should you have any questions or require any additional information, please do not hesitate to contact the undersigned.

Yours sincerely,
WSP E&I Canada Limited

A handwritten signature in blue ink, appearing to read 'Terry Glendenning'.

Terry Glendenning, B.Sc.
Environmental Scientist

WSP E&I Canada Limited prepared this report solely for the use of the intended recipient, Rood Engineering Inc. in accordance with the professional services agreement. The intended recipient is solely responsible for the disclosure of any information contained in this report. The content and opinions contained in the present report are based on the observations and/or information available to WSP E&I Canada Limited at the time of preparation. If a third party makes use of, relies on, or makes decisions in accordance with this report, said third party is solely responsible for such use, reliance or decisions. WSP E&I Canada Limited does not accept responsibility for damages, if any, suffered by any third party as a result of decisions made or actions taken by said third party based on this report. This limitations statement is considered an integral part of this report.

The original of this digital file will be conserved by WSP E&I Canada Limited for a period of not less than 10 years. As the digital file transmitted to the intended recipient is no longer under the control of WSP E&I Canada Limited, its integrity cannot be assured. As such, WSP E&I Canada Limited does not guarantee any modifications made to this digital file subsequent to its transmission to the intended recipient.

EXECUTIVE SUMMARY

WSP E&I Canada Limited (WSP), was retained by Rood Engineering (the Client) to conduct a Soil Characterization Report (SCR) of the Shuttleworth Drain located on the North Side of North Talbot Road, Tecumseh, Ontario (hereinafter referred to as the "Project Area"). A key plan showing the location of the Project Area is provided on Figure 1. Soil sample locations are shown on Figure 2.

As the volume of excess soil to be generated at the Project Area is estimated to be less than 2,000 m³, the planning requirements of Ontario Regulation 406/19, On-Site and Excess Soil Management (O. Reg. 406/19) O. Reg. 406/19 are not required if the soil is not related to an enhanced investigation project area (gas station, garage, used for the operation of dry-cleaning equipment, or industrial use) or for projects for which the primary purpose is to remediate contaminated lands. It is WSP's current understanding that this project meets the O. Reg. 406/19 planning exemption requirements as the Project Area is in a residential setting, has a volume of less than 2,000 m³ and the roadway is not an enhanced investigation site. The planning requirements under O. Reg. 406/19 are described as, Soil Registry, an Assessment of Past Uses (APU), a Sampling and Analysis Plan (SAP), a Soil Characterization Report (SCR), and an Excess Soil Destination Assessment Report (ESDAR). To determine the potential presence of contaminants in the soil and to satisfy the testing requirements for potential excess soil receiver sites analytical testing of the soil in accordance with O. Reg. 406/19 is recommended. The Project Area includes Shuttleworth Drain and this SCR report was prepared.

This SCR was conducted in general accordance with the requirements of clause 12 (4) (c) of Ontario Regulation 406/19 – *On-Site and Excess Soil Management* (O. Reg. 406/19). The SCR was conducted in accordance with the proposed scope of work and Terms of Reference provided in WSP's proposal / work agreement POESASW22363 dated 20 October 2022 and subsequent amendments.

Based on the results of the SCR, soil within the Project Area has been categorized into three zones (Zones 1, 2, and 3). The identified soil zones will be subject to specific requirements in terms of destination locations and/or on-site reuse. The requirements for each soil zone is provided below:

Excess Soil Zone 1 – Soil meeting Table 3 SCS (Excluding EC and SAR) for On-Site Reuse

Soils with concentrations below the Table 3 SCS were identified across the entirety of the Project Area.

The soil designated as Excess Soil Zone 1 can be reused on-site.

Excess Soil Zone 2 – Soil meeting Table 3.1 ESQS/LSL (Excluding EC and SAR) for Beneficial Off-Site Reuse

Soils with concentrations below the Table 3.1 ESQS were identified across the entirety of the Project Area.

The soil designated as Zone 2 can be reused at beneficial reuse sites where Table 3.1 ESQS for I/C/C property use apply.

Excess Soil Zone 3 – Soil exceeding Table 3.1 ESQS/LSL for Off-Site Disposal

Impacted soils exceeding the Table 3.1 ESQS/LSL were not identified at the Project Area. As such, none of the excess soil requires off-site disposal at a licenced landfill facility.



TABLE OF CONTENTS

1	INTRODUCTION.....	1
1.1	Project Area Information.....	1
2	BACKGROUND INFORMATION.....	3
2.1	Assessment of Past Uses Summary.....	3
2.2	Sampling and Analysis Plan.....	3
3	SOIL CHARACTERIZATION SCOPE OF WORK.....	5
3.1	Overview of Site Investigation.....	5
3.2	Deviations from Sampling and Analysis Plans.....	6
4	INVESTIGATION METHODS.....	7
4.1	General.....	7
4.2	Drilling and Excavating.....	7
4.2.1	Soil Sampling.....	7
4.2.2	Shallow soil sample Locations.....	7
4.3	Soil Sampling.....	8
4.3.1	Sampling Method.....	8
4.4	Field Screening Methods.....	8
4.5	Analytical Testing.....	9
4.6	Residue Management Procedures.....	9
4.7	Quality Assurance and Quality Control Measures.....	9
5	REVIEW AND EVALUATION.....	10
5.1	Geology.....	10
5.2	Soil: Field Screening.....	10
5.2.1	Staining and Odours.....	10
5.2.2	COV/TOV Concentrations.....	10



6	REGULATORY FRAMEWORK.....	11
6.1	Ontario Regulation 406/19 – Generic Excess Soil Quality Standards.....	11
6.2	Ontario Regulation 406/19 – Generic Leachate Screening Level.....	11
6.3	Ontario Regulation 153/04 - Soil, Ground Water and Sediment Standards.....	11
7	LABORATORY ANALYSES.....	13
7.1	Soil Analysis	13
7.2	Quality Assurance Program.....	13
8	SOIL REUSE PROTOCOL	14
8.1	Excess Soil Zone 1 – Soil meeting Table 3 SCS (excluding EC and SAR) for On-Site Reuse	14
8.2	Excess Soil Zone 2 – Soil meeting Table 3.1 ESQS / LSLs (excluding EC and SAR) for Off-Site Beneficial Reuse	14
8.3	Excess Soil Zone 3 – Soil exceeding Table 3.1 ESQS/LSL for Off-Site Disposal.....	14
9	SIGNATURES	15
10	REFERENCES.....	16

TABLES

Table 1.1: Property Information	1
Table 1.2: Project Area Owner, Project Leader and Qualified Person Information.....	2
Table 2.1: Areas of Potential Environmental Concern	3
Table 2.2: Summary of Required Number of Samples, Applicable Standards and Leachate Screening Levels.....	3
Table 2.3: Summary of Required Bulk Soil Chemical Analysis Per Soil Sample.....	4
Table 4.1: Soil Sample Locations.....	7
Table 7.1: Soil Analysis	13

TABLES (in order after Text)

Table 1	Summary of Excess Soil Analyses
---------	---------------------------------

FIGURES (in order after Tables)

Figure 1	Key Plan
Figure 2	Project Area Plan View

APPENDICES

Appendix A	Laboratory Certificates of Analysis
Appendix B	Limitations

LIST OF ACRONYMS AND ABBREVIATIONS

ABNs	Acid, Base, Neutral Extractables
APEC	Area of Potential Environmental Concern
APU	Assessment of Past Uses
AST	Aboveground Storage Tank
BH	Borehole
BTEX	Benzene, Toluene, Ethylbenzene and Xylenes
CALA	Canadian Association for Laboratory Accreditation
C of A	Certificate of Approval
CN	Cyanide
COC	Contaminant of Concern
COPC	Contaminant of Potential Concern
COV	Combustible Organic Vapour
CPs	Chlorophenols
CSM	Conceptual Site Model
DNAPL	Dense Non-aqueous Phase Liquid
DO	Dissolved Oxygen
EC	Electrical Conductivity
EPA	Environmental Protection Act
ESA	Environmental Site Assessment
ESQS	Excess Soil Quality Standards
I/C/C	Industrial/Commercial/Community
LNAPL	Light Non-aqueous Phase Liquid
LSL	Leachate Screening Level
mASL	Metres Above Sea Level
mbgs	Metres Below Ground Surface
MECP	Ministry of the Environment, Conservation and Parks
MOE	Ministry of the Environment
MOECC	Ministry of the Environment and Climate Change
MOEE	Ministry of the Environment and Energy
MTM	Modified Transverse Mercator
MW	Monitoring Well
NAPL	Non-aqueous Phase Liquid
PCA	Potentially Contaminating Activity
OCs	Organochlorine Pesticides
ORP	Oxidation Reduction Potential
PCBs	Polychlorinated Biphenyls
PCDDs/PCDFs	Polychlorinated Dibenzodioxins and Polychlorinated Dibenzofurans (Dioxins and Furans)

PHCs	Petroleum Hydrocarbons
PAHs	Polycyclic Aromatic Hydrocarbons
PVC	Polyvinyl Chloride
QA/QC	Quality Assurance/Quality Control
RA	Risk Assessment
RDL	Reporting Detection Limit
RL	Reporting Limit
RPD	Relative Percent Difference
R/P/I	Residential/Parkland/Institutional
RSC	Record of Site Condition
SAP	Sampling and Analysis Plan
SAR	Sodium Adsorption Ratio
SCC	Standards Council of Canada
SCS	Site Condition Standard
SOA	Standing Offer Agreement
SPLP	Synthetic Precipitate Leachate Procedure
TCLP	Toxicity Characteristic Leaching Procedure
THM	Trihalomethanes
TP	Test Pit
µg/g	Micrograms per Gram
USCS	Unified Soil Classification System
UTM	Universal Transverse Mercator
TOV	Total Organic Vapour
UST	Underground Storage Tank
VOCs	Volatile Organic Compounds

1 INTRODUCTION

WSP E&I Canada Limited (“WSP”), was retained by Rood Engineering Inc. (“Client”) to conduct a Soil Characterization Report (SCR) of the Shuttleworth Drain located on the north side of North Talbot Road, Tecumseh, Ontario (hereinafter referred to as the “Project Area”). A key plan showing the location of the Project Area is provided on Figure 1.

As the volume of excess soil to be generated at the Project Area is estimated to be less than 2,000 m³, the planning requirements of Ontario Regulation 406/19, On-Site and Excess Soil Management (O. Reg. 406/19) O. Reg. 406/19 are not required if the soil is not related to an enhanced investigation project area (gas station, garage, used for the operation of dry-cleaning equipment, or industrial use) or for projects for which the primary purpose is to remediate contaminated lands. It is WSP’s current understanding that this project meets the O. Reg. 406/19 planning exemption requirements as the Project Area is in a residential setting, has a volume of less than 2,000 m³ and the roadway is not an enhanced investigation site. The planning requirements under O. Reg. 406/19 are described as, Soil Registry, an Assessment of Past Uses (APU), a Sampling and Analysis Plan (SAP), a Soil Characterization Report (SCR), and an Excess Soil Destination Assessment Report (ESDAR). To determine the potential presence of contaminants in the soil and to satisfy the testing requirements for potential excess soil receiver sites analytical testing of the soil in accordance with O. Reg. 406/19 is recommended. The Project Area includes Shuttleworth Drain and this SCR report was prepared.

The SCR was conducted in accordance with the proposed scope of work and Terms of Reference provided in WSP’s proposal / work agreement POESASW22363 dated 20 October 2022 and subsequent amendments.

1.1 PROJECT AREA INFORMATION

General information concerning the Project Area is provided in Table 1.1 below.

Table 1.1: Property Information

Municipal Address	North side of North Talbot Road					
Current Project Area Use	Active Drain					
Proposed Project Area Use	Active Drain					
UTM (NAD 83)	Zone:	17T	Easting:	340328	Northing:	4677333
Estimated Excess Soil Volume	340 m ³					
Project Area Dimensions	Length:	Approximately 900 m				
	Width:	To be determined based on construction (clearing of bottom of drain)				
	Depth:	Approximately 0.3 m				

Contact information for the Project Area Owner, Project Leader and Qualified Person are provided in Table 1.2 below.

Table 1.2: Project Area Owner, Project Leader and Qualified Person Information

Project Area Owner	Town of Tecumseh	519-735-2184 917 Lesperance Road Tecumseh, Ontario N8N 1W9
Project Leader	Rood Engineering Inc.	Gerard Rood, P.Eng. gerard.reinc@gmail.com 519-322-1621 9 Nelson Street Leamington, Ontario, L8R 2K3
Qualified Person	WSP E&I Canada Limited	Cindy McKee, P.Geo., QP _{ESA} , Senior Environmental Scientist cindy.mckee@wsp.com 519-735-2499 11865 County Road 42, Tecumseh, ON N8N 0H1

2 BACKGROUND INFORMATION

2.1 ASSESSMENT OF PAST USES SUMMARY

As noted in Section 1.0, this project is exempt from the reporting requirements, and as such an APU was not completed. However, WSP completed a preliminary historical review of the Project Area and study area to identify any potential PCAs. The study area was developed for residential use and included some parkland properties. No PCAs were identified were beyond the roadway itself, as outlined in the table below.

Table 2.1: Areas of Potential Environmental Concern

Area of Potential Environmental Concern	Location of APEC on Project Area	Potentially Contaminating Activity*	Location of PCA	Contaminants of Potential Concern
APEC-1: Shuttleworth Drain Construction	Entire Project Area	PCA 1: 30. Importation of Fill Material of Unknown Quality	On-Site: Entire Project Area	M&I, VOCs, PHCs, PAHs
APEC-2: Salt Application on North Talbot Road	Entire Project Area	PCA 2: Other. Salt Application	On-Site: Entire Project Area	EC, SAR

No other environmental, geological or geotechnical reports for the Project Area were provided to or reviewed by WSP.

2.2 SAMPLING AND ANALYSIS PLAN

Based at the volume of soil at each APEC and following the in-situ sampling protocol provided in Section 2 (3) (15) of the Excess Soil Rules Document, the sampling requirements for the Project Area and within each APEC are listed in Table 2.2 below.

Table 2.2: Summary of Required Number of Samples, Applicable Standards and Leachate Screening Levels

APEC	Approximate Soil Volume (m ³)	Associated Sample Location	Required Number of Bulk Samples	Applicable Standards	Required Number of Leachate Samples	Applicable LSL
APEC-1	340	All Sample Locations	3	Table 3.1 ESQS	0	n/a
APEC-2	340	All Sample Locations	3	Table 3.1 ESQS	0	n/a

Table 3.1 ESQS – Table 3.1 Full Depth Excess Soil Quality Standards in a Non-Potable Ground Water Condition for Industrial/Commercial/Community Property Use
n/a – Not applicable

Sampling locations have been assessed to address APECs identified in the APU, see Figure 2 for the soil sample locations. Table 2.3 below outlines the bulk soil sampling requirements at each soil sample location to characterize the excess soil within each APEC.

Table 2.3: Summary of Required Bulk Soil Chemical Analysis Per Soil Sample

Soil Sample Identification	M&I	PHCs	BTEX	PAHs
BH-SD1	0	0	0	0
BH-SD2	1	1	1	1
BH-SD3	0	0	0	0
BH-SD4	0	0	0	0
BH-SD5	1	1	1	1
BH-SD6	0	0	0	0
BH-SD7	0	0	0	0
BH-SD8	1	1	1	1
Total	3	3	3	3
Duplicates	1	1	1	1
Duplicate samples should be collected at a rate of one (1) in ten (10) bulk samples and identified with the naming convention "DUP1, DUP2" etc.				

3 SOIL CHARACTERIZATION SCOPE OF WORK

3.1 OVERVIEW OF SITE INVESTIGATION

The investigations documented in this report were carried out to characterize the subsurface soil conditions within the Project Area with respect to the previously noted APECs and to provide an SCR compliant with the requirements of O. Reg. 406/19. This report is not intended to be a Phase Two Environmental Site Assessment and it is understood that a Record of Site Condition (RSC) filing is not required for the Project Area at this time.

The SCR was conducted in and involved the advancement of eight (8) shallow surface samples at the Project Area, identified as BH-SD1, BH-SD2, BH-SD3, BH-SD4, BH-SD5, BH-SD6, BH-SD7, and BH-SD8 to facilitate the collection of representative soil samples for laboratory analyses.

This SCR was conducted in accordance with the requirements set forth under O. Reg. 406/19 and related supporting documents established there under. The sampling methods employed in carrying out the investigations complied with the requirements established by the MECP in the document entitled *Guidance on Sampling and Analytical Methods for Use at Contaminated Sites in Ontario* (MOEE, 1996). The scope of work for the SCR included of the following tasks:

- Developing a site-specific Health & Safety Plan (HASP) for the intrusive work at the Project Area;
- Arranging for the locations of public and private underground and overhead;
- A subsurface soil sampling program including the sampling of eight (8) screening level surface soil samples for field screening for evidence of negative impact including the presence of “free flowing product”, using visual, olfactory and sample headspace screening methods;
- Submitting select bulk soil samples for laboratory analysis as per Table 2.2 above, suspect contaminants of potential concern (COPC) include: metals & inorganics (metals, hydrides, EC, SAR, pH, hot water soluble boron (HWS-B), hexavalent chromium (Cr(VI)), mercury (Hg) and cyanide (CN⁻); polycyclic aromatic hydrocarbons (PAHs); benzene, toluene, ethylbenzene, and xylenes (BTEX); and petroleum hydrocarbons (PHCs) F1-F4;
- Soil samples should be collected using professionally accepted methods, minimizing the potential of cross contamination, under the supervision of a qualified person;
- Comparing the analytical results reported for the bulk soil samples to the appropriate generic Site Condition Standards (SCS) established by the Ministry of the Environment, Conservation and Parks (MECP) as provided in “*Soil, Ground Water and Sediment Standards for Use under Part XV.1 of the Environmental Protection Act*” dated April 15, 2011 in order to determine on-Site reuse options;
- Comparing the analytical results reported for the bulk and leachate soil samples to the appropriate generic Excess Soil Quality Standards (ESQS) and leachate screening levels (LSL) established by the MECP as provided in “*Rules for Soil Management and Excess Soil Quantity Standards*” dated December 8, 2020 (Excess Soil Rules Document) in order to determine beneficial reuse options; and,

- Preparing a SCR, inclusive of figures, tables, stratigraphic and instrumentation logs and certificates of analysis, documenting the methodology and findings of the investigations and conclusions and recommendations regarding soil quality and the need for additional investigation and/or remedial activities, and determining the classification of potential receiver sites.

It should be noted that based on the low volume, synthetic precipitate leaching procedure (SPLP) laboratory analysis was not required. Additionally, toxic characteristic leachate procedure (TCLP) laboratory analysis was not required based on the absence of exceedances of Table 3.1 ESQS/LSL.

3.2 DEVIATIONS FROM SAMPLING AND ANALYSIS PLANS

No significant deviations were made from WSP's proposal.

4 INVESTIGATION METHODS

4.1 GENERAL

The SCR was carried out in accordance with the SAP, with the deviations listed on Section 3.2, and in accordance with the WSP Standard Operating Procedures (SOP) cited therein.

4.2 DRILLING AND EXCAVATING

The locations of all buried and overhead services were obtained prior to Initiating any of the subsurface investigations.

4.2.1 SOIL SAMPLING

The shallow soil investigation was completed by WSP utilizing a hand auger. The shallow soil samples were advanced to depth of 0.3 metres below ground surface (mbgs) on 7 November 2022. Sampling tools were washed with phosphate free soap and rinsed with distilled water between samples.

4.2.2 SHALLOW SOIL SAMPLE LOCATIONS

The shallow soil sample locations are provided in the table below and shown on Figure 2,

Table 4.1: Soil Sample Locations

Sample Identification	Station ID	Soil Location Description	Soil Description	COVs
BH-SD1	West of Station 0+004	West of Property line of 4976 North Talbot Road	Brown sand fill with clay	0 ppm
BH-SD2	Station 0+144.3	East of Driveway of 5074 North Talbot Road	Brown-grey mottled silty clay fill with trace sand and gravel	5 ppm
BH-SD3	Station 0+257.8	West Property Line of Weston Park	Brown-grey mottled silty clay fill with trace sand and gravel	0 ppm
BH-SD4	Station 0+398.5	East of Driveway of Weston Park	Brown sand fill with clay	0 ppm
BH-SD5	Station 0+528.2	West Property Line of 5466 North Talbot Road	Brown sand fill with clay	5 ppm
BH-SD6	Station 0+610.7	East of Driveway to 5480 North Talbot Road	Brown silty clay fill with organics	0 ppm
BH-SD7	Station 0+688.6	East of Driveway of 5520 North Talbot Road	Brown sand fill with organics	5 ppm
BH-SD8	Station 0+821.7	East of Driveway of 5700 North Talbot Road	Brown sand fill with clay and organics	0 ppm

4.3 SOIL SAMPLING

4.3.1 SAMPLING METHOD

The soil samples retrieved during the shallow soil sampling program were examined, classified, and logged according to soil type, moisture content, colour, consistency, and presence of visual and/or olfactory indicators of negative impact. The soil samples recovered at the Project Area were subsampled based on visual observations including fill/soil type and visual/olfactory evidence of suspected impact.

Soil samples were split into duplicate fractions upon recovery at the surface. The primary sample fractions were placed in laboratory supplied glass sample jars and stored in coolers with ice for potential laboratory analysis. Samples selected for analysis of volatile parameters including VOC (including BTEX) and PHC F1 were micro-cored and field preserved using methanol charged vials supplied by the analytical laboratory to minimize potential losses due to volatilization. The duplicate sample fractions were placed in “Ziploc” sample bags and stored at ambient temperature for subsequent field vapour screening purposes.

All soil samples were collected in accordance with strict environmental sampling protocols to minimize loss of volatile organics and to ensure reliable and representative results. Disposable nitrile gloves were used and replaced between the handling of successive samples. All soil sampling equipment (stainless steel trowels, spatulas, etc.) was thoroughly decontaminated between soil sample locations to prevent potential cross-contamination. Decontamination activities included:

- Physical removal of any adhered debris;
- Wash/scrub in “Alconox” soap solution;
- Distilled water rinse;
- Methanol rinse; and
- Air dry.

Soil samples considered to be representative of “worst-case” environmental conditions were selected for chemical analysis based on visual and olfactory observations made in the field and on field screening results.

4.4 FIELD SCREENING METHODS

All soil samples were screened in the field for gross evidence of negative environmental impact including staining and odours. Soil sample headspace screening was also performed to facilitate sample selections for laboratory analysis and to provide a semi-quantitative assessment of the vertical contaminant distributions at each soil sample location. The duplicate soil sample fractions were screened for COV concentrations using the sample headspace method. COV concentrations were measured using an RKI Eagle 2 combined combustible gas analyzer (CGA). Where COV measurements were made, the instrument was operated in the methane elimination mode. The RKI Eagle 2 was calibrated at the start of the field sampling programs using hexane reference gas (1650 ppm). The resolution of the instrument is 5 ppm hexane equivalent. The instrument response is compound specific. The measured soil vapour concentrations for COV are included in the stratigraphic and instrument logs in Appendix A and discussed in Section 5.2.2.

4.5 ANALYTICAL TESTING

Representative soil samples collected during the investigation were submitted for laboratory analysis of suspect parameters of concern. All laboratory chemical analyses were conducted by Paracel Laboratories Ltd. of Hamilton, Ontario. Paracel is accredited by the Canadian Association for Laboratory Accreditation Inc. (CALA) in accordance with ISO/IEC 17025:2017 – “General Requirements for the Competence of Testing and Calibration Laboratories” for the tested parameters set out in the Soil, Ground Water and Sediment Standards.

4.6 RESIDUE MANAGEMENT PROCEDURES

Investigation-derived wastes including soil cuttings generated during the investigation were placed back into the shallow soil sampling location.

4.7 QUALITY ASSURANCE AND QUALITY CONTROL MEASURES

A strict Quality Control (QA/QC) program was implemented and maintained throughout the project to ensure that the Project Area data are representative of the actual Project Area conditions. The QA/QC program provides a method of documented checks to assess the precision and accuracy of collected data. The QA/QC program includes a set of standard procedures or protocols to be followed throughout the investigations. To this end, WSP field and QA/QC protocols have been developed to meet or exceed those defined in the Ministry of the Environment (MOE) documents entitled “*Guideline for Phase II Environmental Site Assessments in Ontario*” (Draft, March 2006) and “*Guidance on Sampling and Analytical Methods for Use at Contaminated Sites in Ontario*” (1996) and Canadian Council of Ministers of the Environment (CCME) “*Guidance Manual Sampling, Analysis, and Data Management for Contaminated Sites*” (1993). The field QC program included the following components:

- 1 The use of personnel protective equipment including hard hats, safety glasses, safety work boots and chemically resistant latex/nitrile gloves for sample handling;
- 2 Thorough documentation of all field activities and sample handling practices including field notes, chain of custody forms, memos to file, etc.;
- 3 Thorough decontamination of non-dedicated sampling equipment employed in all investigation phases;
- 4 The use of laboratory analytical protocols and method detection limits that have been established in accordance with regulatory requirements for the Province of Ontario.

The “*Protocol for Analytical Methods Used in the Assessment of Properties under Part XV.1 of the Environmental Protection Act*”, 09 March 2004, amended as of 01 July 2011 (the “Analytical Protocol”), establishes performance criteria for use when assessing the reliability of data reported by analytical laboratories. These include maximum hold times for the storage of samples/sample extracts between collection and analysis, specified/approved analytical methods, required laboratory quality assurance samples such as blanks and field and laboratory duplicates, specified recovery ranges for spiked samples and surrogates (compounds added to samples in known concentrations for quality assurance purposes), Reporting Limits (RLs) and specified precision required when analyzing laboratory duplicate and spike/controlled reference material samples.

5 REVIEW AND EVALUATION

5.1 GEOLOGY

The subsurface conditions encountered at the Project Area are described in the provided in Table 4.1. In general, the soil conditions at the Project Area consisted of surficial fill consisting of sand and clay with some organics.

5.2 SOIL: FIELD SCREENING

5.2.1 STAINING AND ODOURS

No odours or staining suggestive of petroleum hydrocarbon impacts were detected in any of the soil and/or sediment samples collected at the Project Area.

5.2.2 COV/TOV CONCENTRATIONS

COV concentration headspace measurements recorded in the soil samples collected at the Project Area were all between 0 (non-detectable) and 5 ppm. These concentrations are not indicative of impact by petroleum hydrocarbons. The COV results are semi-quantitative at best and are generally only used for relative sample comparison purposes when selecting samples for laboratory analysis. The COV concentrations headspace measurements are summarized in Table 4.1.

6 REGULATORY FRAMEWORK

6.1 ONTARIO REGULATION 406/19 – GENERIC EXCESS SOIL QUALITY STANDARDS

The analytical results were compared to the criteria presented in the MECP document titled “*Rules for Soil Management and Excess Soil Quality Standards*” dated December 8, 2020. Based on the proposed volume of excess soil to be generated at the project area (340 m³), the volume independent ESQS (applicable for excess soil quantities greater than 350 m³) were applied.

Based on the requirements of the Client and the intended reuse of the excess soil, the ESQS for industrial/commercial/community (ICC) property use in potable groundwater conditions were selected for assessment purposes. The soil analytical results were assessed using the Full Depth Excess Soil Quality Standards in a Non-Potable Ground Water Condition for ICC property Use (Table 3.1 ESQS).

6.2 ONTARIO REGULATION 406/19 – GENERIC LEACHATE SCREENING LEVEL

As the volumes of the soil being removed from the Project Area were less than 350 m³, mSPLP analysis was not required in accordance with O. Reg. 406/19.

6.3 ONTARIO REGULATION 153/04 - SOIL, GROUND WATER AND SEDIMENT STANDARDS

In order to determine suitability of soil for on Site reuse, the analytical data has been compared to O. Reg 153/04 Site Condition Standards (SCS) as described in the “*Soil, Ground Water and Sediment Standards for Use under Part XV.1 of the Environmental Protection Act*” dated 15 April 2011. In order to determine the applicable SCS, WSP reviewed the existing Project Area use and site specific conditions including: 1) the existing/proposed property use; 2) the existing/potential ground water use; 3) depth of clean-up; 4) soil texture; 5) depth to bedrock; 6) proximity to a water body; and 7) soil pH.

The SCS applicable to the Project Area have been evaluated based on the following rationale:

- There are no known areas of natural significance¹ or conditions in the vicinity of the Project Area, which would cause the Project Area to be classified as potentially sensitive according to the Ministry of Natural Resources’ Natural Heritage Information Centre web site;

¹ An “Area of Natural Significance” means any of the following: 1) An area reserved or set apart as a provincial park or conservation reserve under the Provincial Parks and Conservation Reserves Act, 2006; 2) An area of natural and scientific interest (life science or earth science) identified by the Ministry of Natural Resources as having provincial significance; 3) A wetland identified by the Ministry of Natural Resources as having provincial significance; 4) An area designated by a municipality in its official plan as environmentally significant, however expressed, including designations of areas as environmentally sensitive, as being of environmental concern and as being ecologically significant; 5) An area

- Based on knowledge of the area, the depth of the soil on the Project Area is greater than 2.0 mbgs;
- The Project Area is not considered a “shallow soil property” as defined by O. Reg. 153/04;
- The Project Area is in an area of non-potable ground water and the Project Area and surrounding properties are supplied with municipal water system;
- The Project Area does not include, is not adjacent to, and does not include land that is within 30 m of a water body. The Shuttleworth Drain is not considered a permanent water body. The nearest waterbody is the Detroit River located approximately 12.5 kilometers north of the Project Area. Regional ground water flow on the Project Area is anticipated to flow to the north (towards the Detroit River);
- The existing and intended future use of the Project Area is roadway (ICC);
- Soil pH values measured at the Project Area were within the required range of 5 – 9 for surface soils and 5 to 11 for subsurface soils; and,
- Based soils, subsurface soil conditions across the Project Area are likely fine, however due to no grain size being completed for the Project Area, the soils are classified to the more stringent standard (coarse textured soil) for the purposes of this assessment.

Based on the Project Area characteristics and the continued use as a municipal drain, the Table 3 SCS for I/C/C property use and coarse textured soils in a non-potable ground water condition as provided in *Soil, Ground Water and Sediment Standards for Use under Part XV.1 of the Environmental Protection Act* (MECP, April 15, 2011) have been applied in assessing the soil quality at the Project Area.

designated as an escarpment natural area or an escarpment protection area by the Niagara Escarpment Plan under the Niagara Escarpment Planning and Development Act; 6) An area identified by the Ministry of Natural Resources as significant habitat of a threatened or endangered species; 7) An area which is habitat of a species that is classified under section 7 of the Endangered Species Act, 2007 as a threatened or endangered species; 8) Property within an area designated as a natural core area or natural linkage area within the area to which the Oak Ridges Moraine Conservation Plan under the Oak Ridges Moraine Conservation Act, 2001 applies; and 9) An area set apart as a wilderness area under the Wilderness Areas Act.

7 LABORATORY ANALYSES

The results of the soil sample analyses carried out as part of this investigation are summarized in Table 1 (attached). Copies of the laboratory Certificates of Analysis are provided in Appendix A.

7.1 SOIL ANALYSIS

The results of the soil sample analyses in the context of the applicable ESQS and SCS are shown in Table 7.1 below,

Table 7.1: Soil Analysis

APEC	Approximate Soil Volume (m ³)	Table 3.1 ESQS Exceedances	Table 3 SCS Exceedances
APEC-1	340	BH-SD2 – Sodium Adsorption Ratio	BH-SD2 – Sodium Adsorption Ratio
APEC-2	340	BH-SD2 – Sodium Adsorption Ratio	BH-SD2 – Sodium Adsorption Ratio

7.2 QUALITY ASSURANCE PROGRAM

Duplicate samples are analyzed to assess the precision of the field sampling and laboratory analytical processes. Relative percent difference (RPD) acceptance limits only apply where the average of the results for the sample and its duplicate is greater than five times the laboratory reportable detection limit (RDL).

The soil field QA/QC program consisted of analyzing blind field duplicate samples for PHC F1 to F4, BTEX, PAHs, and metals and inorganics. The RPD values could not be calculated for analyzed chemical parameters with measured concentrations less than five (5) times their respective RDLs. RPDs for those parameters with measured concentrations/values greater than five (5) times their RDLs were within acceptable limits.

All samples/sample extracts were analyzed within their applicable hold times using approved analytical methods. The RLs were met for all tested parameters. No parameters were detected in any laboratory method blank. Surrogate recoveries were within acceptable ranges in all cases for all samples. Agreement between the corresponding datasets for the reference material samples where applicable and recoveries reported for spiked samples/blanks, where applicable, is acceptable. Agreement between the corresponding datasets for the laboratory duplicate samples is considered acceptable. The overall quality control for this analysis meets acceptability criteria. In summary, the analytical results reported for samples collected during this investigation are considered to have met the performance criteria of the Analytical Protocol.

8 SOIL REUSE PROTOCOL

Based on the results of the SCR, soil within the project area has been categorized into three zones (Zones 1, 2 and 3). The identified soil zones will be subject to specific requirements in terms of destination locations and/or on-site reuse. The approximate extent of the Excess Soil Zones has been delineated to soil sample locations advanced as part of this investigation and the limits of the Project Area. The requirements for each soil zone is provided below:

8.1 EXCESS SOIL ZONE 1 – SOIL MEETING TABLE 3 SCS (EXCLUDING EC AND SAR) FOR ON-SITE REUSE

Soils with concentrations below the Table 3 SCS were identified across the entirety of the Project Area.

The soil designated as Zone 1 can be reused on-site.

8.2 EXCESS SOIL ZONE 2 – SOIL MEETING TABLE 3.1 ESQS / LSLs (EXCLUDING EC AND SAR) FOR OFF-SITE BENEFICIAL REUSE

Soils with concentrations below the Table 3.1 ESQS were identified across the entirety of the Project Area.

The soil designated as Zone 2 can be reused at beneficial reuse sites where Table 3.1 ESQS for I/C/C property use apply.

8.3 EXCESS SOIL ZONE 3 – SOIL EXCEEDING TABLE 3.1 ESQS/LSL FOR OFF-SITE DISPOSAL

Impacted soils exceeding the Table 3.1 ESQS/LSL were not identified at the Project Area. As such, none of the excess soil requires off-site disposal at a licenced landfill facility.

9 SIGNATURES

I, Terry Glendenning, B.Sc., by the signature provided below, certify that I conducted or supervised the carrying out of this SCR and the findings and conclusions of the report. I Cindy McKee, P. Geo., QP_{ESA}, by the signature provided below, certify that I completed a technical review of this SCR and concur with the findings and conclusions of the report.

Respectfully Submitted,
WSP E&I Canada Limited

Prepared by:



Terry Glendenning, B.Sc.
Environmental Scientist
terry.glendenning@wsp.com

Reviewed by:



Cindy McKee, B.Sc., P.Geo., QP_{ESA}
Senior Environmental Scientist
cindy.mckee@wsp.com

10 REFERENCES

- Ontario Geologic Survey, 2007. "Paleozoic Geology of Southern Ontario (MRD219)".
- Ontario Geologic Survey, 2010. "Surficial Geology of Southern Ontario (MRD128)".
- Ontario Ministry of the Environment. March 9, 2004, amended July 1, 2011 and November 30, 2020. Version 3.0. "Protocol for Analytical Methods Used in the Assessment of Properties under Part XV.1 of the Environmental Protection Act".
- Ontario Ministry of the Environment, 15 April 2011. "Soil, Ground Water and Sediment Standards for Use under Part XV.1 of the Environmental Protection Act", PIBS # 7382e01.
- Ontario Ministry of Environment, Conservation and Parks, 2004. "Ontario Regulation 153/04 – Records of Site Condition – Part XV.1 of the Environmental Protection Act".
- Ontario Ministry of Environment, Conservation and Parks., 1990. "Ontario Regulation 347/90 – General – Waste Management".
- Ontario Ministry of Environment, Conservation and Parks, December 4, 2019. "Ontario Regulation 406/19 made under the Environmental Protection Act, On-Site and Excess Soil Management".
- Ontario Ministry of Environment, Conservation and Parks, 2022. "Rules for Soil Management and Excess Soil Quality Standards".
- Ontario Ministry of the Environment and Energy, December 1996. "Guidance on Sampling and Analytical Methods for Use at Contaminated Sites in Ontario".

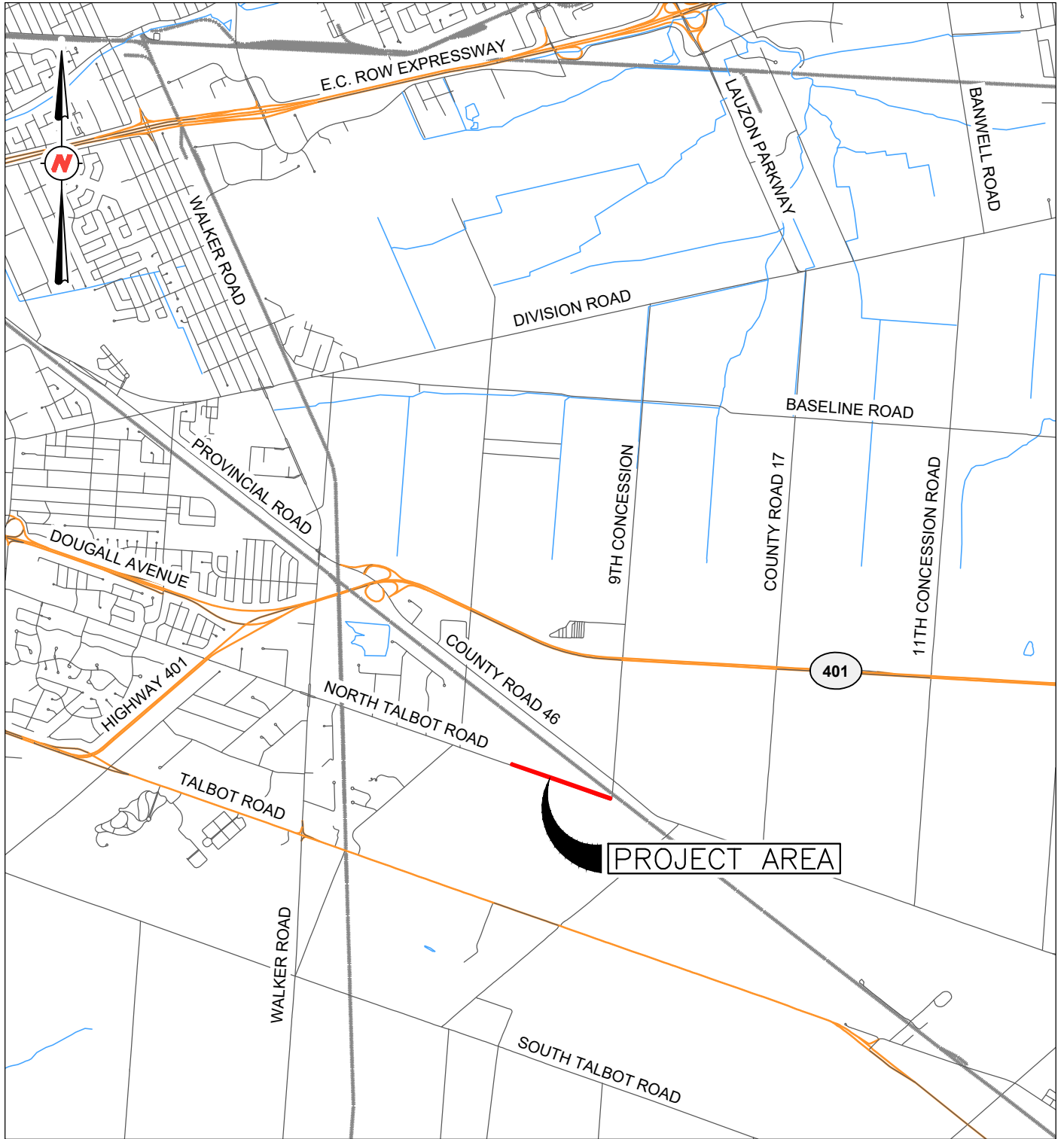

NOTES:
 THIS DRAWING SHOULD BE READ IN CONJUNCTION WITH THE WSP E&I CANADA LIMITED
 REPORT No. OESAW2232. ALL LOCATIONS ARE APPROXIMATE.
 ORIGINAL PAPER SIZE: 8½ x 11.

REFERENCES:
 CANMAP STREETFILES V2008.4.

CLIENT:		DWN BY:	PROJECT:	DATE:
Rood Engineering 9 NELSON STREET LEAMINGTON, ONTARIO N8H 1G6		LMK	SOIL CHARACTERIZATION REPORT SHUTTLEWORTH DRAIN WINDSOR, ONTARIO	NOV. 2022
		CHK'D BY:		PROJECT No:
WSP E&I Canada Limited 11865 COUNTY ROAD 42 TECUMSEH, ONTARIO, N8N 0H1 519-735-2499		TG	TITLE: KEY PLAN	OESAW2232
		DATUM:		REV No:
		NAD83	FIGURE No: 1	0
		PROJECTION:		
		UTM Zone 17		
		SCALE:		
		1:50,000		

DATE PLOTTED: 11/24/2022 3:54:21 PM
 FILE LOCATION: W:\2022\ESA and Remediation\Projects\OESAW2232 - Road Engineering (Shuttleworth Drain)\14_CAD\Drafting\AutoCAD files\OESAW2232-R01001.dwg

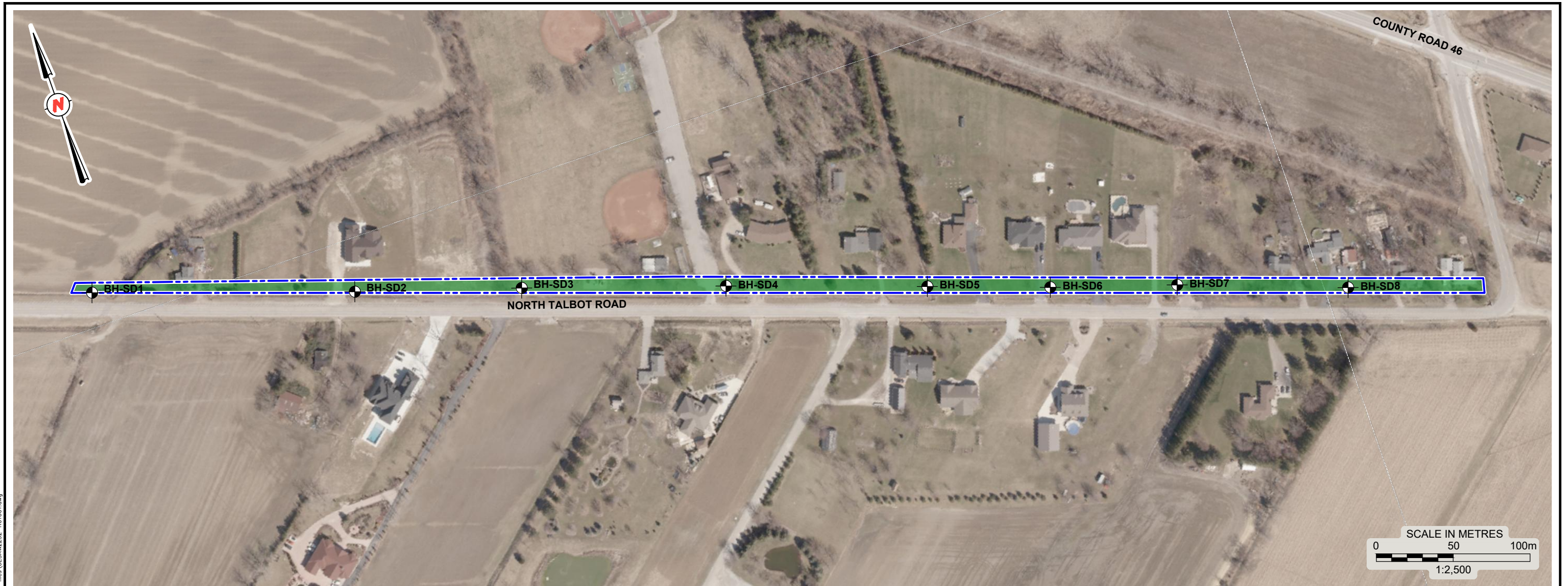

LEGEND:

- APPROXIMATE PROJECT AREA BOUNDARY
- BOREHOLE LOCATION
- EXCESS SOIL ZONE 1 – SOIL MEETING TABLE 3 SCS FOR ON-SITE REUSE (EXCLUDING EC AND SAR)
- EXCESS SOIL ZONE 2 – SOIL MEETING TABLE 3.1 ESQS (EXCLUDING EC AND SAR) FOR BENEFICIAL OFF-SITE REUSE
- EXCESS SOIL ZONE 3 – SOIL EXCEEDING TABLE 3.1 ESQS FOR OFF-SITE DISPOSAL

- LOCATIONS (FROM APPENDIX E1 R2):**
 BH-SD1 - WEST OF STATION 0+004 (WEST SIDE OF WASHBROOK DRAIN)
 BH-SD2 - STATION 0+144.3
 BH-SD3 - STATION 0+257.8
 BH-SD4 - STATION 0+398.5
 BH-SD5 - STATION 0+528.2
 BH-SD6 - STATION 0+610.7
 BH-SD7 - STATION 0+688.6
 BH-SD8 - STATION 0+821.7

NOTES:
 THIS DRAWING SHOULD BE READ IN CONJUNCTION WITH THE WSP E&I CANADA LIMITED REPORT No. OESAW2232.

ALL LOCATIONS ARE APPROXIMATE.

ORIGINAL PAPER SIZE: 11 x 17

REFERENCES:
 2022 AERIAL PHOTOGRAPHS BY THE COUNTY OF ESSEX.

CLIENT:
Rood Engineering
 9 NELSON STREET
 LEAMINGTON, ONTARIO N8H 1G6

WSP E&I Canada Limited
 11865 COUNTY ROAD 42
 TECUMSEH, ONTARIO, N8N 0H1
 519-735-2499



DWN BY: LMK
 CHK'D BY: TG
 DATUM: NAD83
 PROJECTION: UTM Zone 17
 SCALE: 1:2,500

PROJECT:
**SOIL CHARACTERIZATION REPORT
 SHUTTLEWORTH DRAIN
 WINDSOR, ONTARIO**

TITLE:
PROJECT AREA PLAN VIEW

DATE: NOV. 2022
 PROJECT No: OESAW2232
 REV No: 0
 FIGURE No: 2

Notes on Excess Soil Analytical Summary Tables

All Units in Micrograms per Gram (µg/g) Except Where Indicated Otherwise.

RDL = Laboratory Analytical Reporting Detection Limit.

RL = MOE 2011 Analytical Protocol Reporting Limit.

- = Not Analyzed or No Published Value.

DUP = Quality Assurance/Quality Control Duplicate Sample.

RPD = Relative Percent Difference (Between Primary and Duplicate Samples).

* Denotes RPD Exceeds Recommended Alert Criterion Exceeded, However, Parameter Concentration Less than 5 Times Laboratory RDL.

< = Less Than Laboratory Analytical Reporting Detection Limit.

(a) The Boron Standards are for Hot Water Soluble Extract for All Surface Soils. For Subsurface Soils the Standards are for Total Boron (Mixed Strong Acid Digest), Since Plant Protection for Soils Below the Root Zone is not a Significant Concern.

(b) Analysis for Methyl Mercury Only Applies When Mercury (Total) Standard is Exceeded.

(c) F1 Fraction Does Not Include BTEX; However, the Proponent has the Choice as to Whether or not to Subtract BTEX from the Analytical Result.

(d) The Methyl naphthalene Standards are Applicable to Both 1-Methyl Naphthalene and 2-Methyl Naphthalene, with the Provision that if Both are Detected the Sum of the Two Must not Exceed the Standard.

55	Parameter Concentration May Exceed Applicable Standard Due to Elevated Method Detection Limit.
183	Parameter Concentration Exceeds MECP Table 3.1 Full Depth Excess Soil Standard for Industrial/Commercial/Community (I/C/C) Property Use.
797	Parameter Concentration Exceeds MECP Table 3 Full Depth Generic Site Condition Standards in a Non-Potable Ground Water Condition for Industrial/Commercial/Community (I/C/C) Property Use.

Excess Soil Standards = Rules for Soil Management and Excess Soil Quality Standards, Ontario Ministry of the Environment, Conservation and Parks, 2019.

Inputted by: CM

Reviewed by: TG



Table 1. Summary of Excess Soil Analyses

Parameters	Sample Location				Excess Soil ESQS	EPA Standard Full Depth	BH-SD2 BH-SD2 Silty Clay 0.3 Parcel 2246133-01 11/7/2022 11/11/2022	DUP-SD3 (BH-SD2) Silty Clay 0.3 Parcel 2246133-04 11/7/2022 11/11/2022	Averag	RPD	BH-SD5 BH-SD5 Sandy Clay Fill 0.3 Parcel 2246133-02 11/7/2022 11/11/2022	BH-SD8 BH-SD8 Sandy Clay Fill 0.3 Parcel 2246133-03 11/7/2022 11/11/2022
	ATG	Units	RDL	RL								
Metals												
Antimony	Metal	µg/g	0.8	1	40	40	<	<	NC	NC	<	<
Arsenic	Metal	µg/g	1	1	18	18	9.9	10.4	10.15	4.9	6.6	4.5
Barium	Metal	µg/g	2.0	5	670	670	75.2	75.4	75.3	0.3	100	81.9
Beryllium	Metal	µg/g	0.4	2	8	8	0.8	0.8	0.8	0.0	0.6	<
Boron, available	Metal	µg/g	0.5	0.5	2	2	0.7	0.6	0.65	15.4	1.0	0.9
Boron (total)	Metal	µg/g	5	5	120	120	8.7	11.6	10.15	28.6	6.9	<
Cadmium	Metal	µg/g	0.5	1	1.9	1.9	<	<	NC	NC	0.6	<
Chromium VI	Metal	µg/g	0.2	0.2	8	10	0.2	<	NC	NC	<	<
Chromium Total	Metal	µg/g	5	5	160	160	23.7	24.5	24.1	3.3	25.0	10.6
Cobalt	Metal	µg/g	0.5	2	80	80	10.8	10.7	10.75	0.9	6.9	3.8
Copper	Metal	µg/g	1.0	5	230	230	18.8	19.1	18.95	1.6	30.0	13.6
Lead	Metal	µg/g	1	10	120	120	11.5	11.4	11.45	0.9	28.5	13.2
Mercury	Metal	µg/g	0.1	0.1	0.27	20	<	<	NC	NC	<	<
Molybdenum	Metal	µg/g	0.5	2	40	40	1.9	2	1.95	5.1	1.5	1.9
Nickel	Metal	µg/g	1	5	270	270	30.2	29	29.6	4.1	20.4	11.1
Selenium	Metal	µg/g	0.8	1	5.5	5.5	<	<	NC	NC	<	<
Silver	Metal	µg/g	0.5	0.5	40	40	<	<	NC	NC	<	<
Thallium	Metal	µg/g	0.5	1	3.3	3.3	<	<	NC	NC	<	<
Uranium	Metal	µg/g	0.50	1	33	33	1.0	1.1	1.05	9.5	<	<
Vanadium	Metal	µg/g	0.4	10	86	86	40.4	43.7	42.05	7.8	31.4	18.6
Zinc	Metal	µg/g	5	30	340	340	58.4	58.5	58.45	0.2	191	54.7
Other Regulated Parameters												
Sodium Adsorption Ratio	ORP	-	n/a	5	12	12	13.2	11.2	12.2	16.4	3.1	8
Electrical Conductivity (mS/cm)	ORP	mS/cm	0.005	0.7	1.4	1.4	1.04	1.13	1.085	8.3	0.396	0.758
Cyanide, free	ORP	µg/g	0.03	0.03	0.051	0.051	<	<	<	<	<	<
pH	ORP	-	n/a	0.1	12	12	6.78	7.32	7.05	7.7	7.08	7.3
Petroleum Hydrocarbons												
Petroleum Hydrocarbons F1 ^a	PHC	µg/g	7	10	25	55	<	<	NC	NC	<	<
Petroleum Hydrocarbons F2	PHC	µg/g	4	10	26	230	<	<	NC	NC	<	<
Petroleum Hydrocarbons F3	PHC	µg/g	8	50	1700	1700	<	16	NC	NC	134	137
Petroleum Hydrocarbons F4	PHC	µg/g	6	50	3300	3300	<	<	NC	NC	248	439
Volatile Organic Compounds												
Benzene	VOC	µg/g	0.02	0.02	0.034	0.32	<	<	NC	NC	<	<
Toluene	VOC	µg/g	0.05	0.2	7.8	9.5	<	<	NC	NC	<	<
Ethylbenzene	VOC	µg/g	0.05	0.05	1.9	68	<	<	NC	NC	<	<
Xylenes, m,p-	VOC	µg/g	0.05	-	-	-	<	<	NC	NC	<	<
Xylene, o-	VOC	µg/g	0.05	-	-	-	<	<	NC	NC	<	<
Xylene Mixture	VOC	µg/g	0.05	0.05	3	26	<	<	NC	NC	<	<
Semi-Volatiles												
Acenaphthene	sVOC	µg/g	0.02	0.02	15	96	<	<	NC	NC	<	<
Acenaphthylene	sVOC	µg/g	0.02	0.02	0.093	0.15	<	<	NC	NC	<	<
Anthracene	sVOC	µg/g	0.02	0.02	0.16	0.67	<	<	NC	NC	<	<
Benzo[a]anthracene	sVOC	µg/g	0.02	0.02	1	0.96	<	<	NC	NC	0.03	0.04
Benzo[a]pyrene	sVOC	µg/g	0.02	0.02	0.7	0.3	<	<	NC	NC	0.04	0.04
Benzo[b]fluoranthene	sVOC	µg/g	0.02	0.02	7	0.96	<	<	NC	NC	0.04	0.04
Benzo[g,h,i]perylene	sVOC	µg/g	0.02	0.02	13	9.6	<	<	NC	NC	0.04	0.03
Benzo[k]fluoranthene	sVOC	µg/g	0.02	0.02	7	0.96	<	<	NC	NC	<	<
Chrysene	sVOC	µg/g	0.02	0.02	14	9.6	<	<	NC	NC	0.03	0.03
Dibenzo[a,h]anthracene	sVOC	µg/g	0.02	0.02	0.7	0.1	<	<	NC	NC	<	<
Fluoranthene	sVOC	µg/g	0.02	0.02	70	9.6	<	<	NC	NC	0.07	0.07
Fluorene	sVOC	µg/g	0.02	0.02	6.8	62	<	<	NC	NC	<	<
Indeno [1,2,3-cd] pyrene	sVOC	µg/g	0.02	0.02	0.76	0.76	<	<	NC	NC	0.04	0.04
1-Methylnaphthalene	sVOC	µg/g	0.02	0.02	8.7	76	<	<	NC	NC	<	<
2-Methylnaphthalene	sVOC	µg/g	0.02	0.02	8.7	76	<	<	NC	NC	<	<
Methylnaphthalene (1&2)	sVOC	µg/g	0.04	0.04	8.7	76	<	<	NC	NC	<	<
Naphthalene	sVOC	µg/g	0.01	0.01	1.8	9.6	<	<	NC	NC	<	<
Phenanthrene	sVOC	µg/g	0.02	0.02	12	12	<	<	NC	NC	0.03	0.02
Pyrene	sVOC	µg/g	0.02	0.02	70	96	<	<	NC	NC	0.04	0.05

Appendix A

Laboratory Certificates of Analysis



Certificate of Analysis

WSP E&I Canada Limited (Windsor)

11865 County Road 42
Tecumseh, ON N8N 2M1
Attn: Cindy McKee

Client PO: OESAW2232.****.****.5120.573000
Project: OESAW2232.****.****.5120.573000

Custody:

Report Date: 11-Nov-2022
Order Date: 7-Nov-2022

Order #: 2246133

This Certificate of Analysis contains analytical data applicable to the following samples as submitted:

Parcel ID	Client ID
2246133-01	BH-SD2
2246133-02	BH-SD5
2246133-03	BH-SD8
2246133-04	DUP-SD3

Approved By:



Milan Ralitsch, PhD

Senior Technical Manager

Certificate of Analysis

Report Date: 11-Nov-2022

Client: WSP E&I Canada Limited (Windsor)

Order Date: 7-Nov-2022

Client PO: OESAW2232.****.****.5120.573000

Project Description: OESAW2232.****.****.5120.573000

Analysis Summary Table

Analysis	Method Reference/Description	Extraction Date	Analysis Date
Boron, available	MOE (HWE), EPA 200.8 - ICP-MS	10-Nov-22	10-Nov-22
BTEX by P&T GC-MS	EPA 8260 - P&T GC-MS	9-Nov-22	11-Nov-22
Chromium, hexavalent - soil	MOE E3056 - Extraction, colourimetric	9-Nov-22	11-Nov-22
Conductivity	MOE E3138 - probe @25 °C, water ext	10-Nov-22	10-Nov-22
Cyanide, free	MOE E3015 - Auto Colour, water extraction	9-Nov-22	9-Nov-22
Mercury by CVAA	EPA 7471B - CVAA, digestion	10-Nov-22	11-Nov-22
pH, soil	EPA 150.1 - pH probe @ 25 °C, CaCl buffered ext.	8-Nov-22	9-Nov-22
PHC F1	CWS Tier 1 - P&T GC-FID	9-Nov-22	11-Nov-22
PHCs F2 to F4	CWS Tier 1 - GC-FID, extraction	10-Nov-22	11-Nov-22
REG 153: Metals by ICP/MS, soil	EPA 6020 - Digestion - ICP-MS	10-Nov-22	10-Nov-22
REG 153: PAHs by GC-MS	EPA 8270 - GC-MS, extraction	9-Nov-22	10-Nov-22
SAR	Calculated	10-Nov-22	11-Nov-22
Solids, %	CWS Tier 1 - Gravimetric	9-Nov-22	9-Nov-22

Certificate of Analysis

Report Date: 11-Nov-2022

Client: **WSP E&I Canada Limited (Windsor)**

Order Date: 7-Nov-2022

Client PO: OESAW2232.****.****.5120.573000

Project Description: OESAW2232.****.****.5120.573000

Summary of Criteria Exceedances

(If this page is blank then there are no exceedances)

Only those criteria that a sample exceeds will be highlighted in red

Regulatory Comparison:

Paracel Laboratories has provided regulatory guidelines on this report for informational purposes only and makes no representations or warranties that the data is accurate or reflects the current regulatory values. The user is advised to consult with the appropriate official regulations to evaluate compliance. Sample results that are highlighted have exceeded the selected regulatory limit. Calculated uncertainty estimations have not been applied for determining regulatory exceedances.

Sample	Analyte	MDL / Units	Result	-	-
--------	---------	-------------	--------	---	---

Certificate of Analysis

Report Date: 11-Nov-2022

Client: WSP E&I Canada Limited (Windsor)

Order Date: 7-Nov-2022

Client PO: OESAW2232.****.****.5120.573000

Project Description: OESAW2232.****.****.5120.573000

Client ID:	BH-SD2	BH-SD5	BH-SD8	DUP-SD3	-	-
Sample Date:	07-Nov-22 00:00	07-Nov-22 00:00	07-Nov-22 00:00	07-Nov-22 00:00	-	-
Sample ID:	2246133-01	2246133-02	2246133-03	2246133-04	-	-
Matrix:	Soil	Soil	Soil	Soil	-	-
MDL/Units						

Physical Characteristics

% Solids	0.1 % by Wt.	82.1	89.6	83.6	81.3	-	-
----------	--------------	------	------	------	------	---	---

General Inorganics

SAR	0.01 N/A	13.2	3.10	8.00	11.2	-	-
Conductivity	5 uS/cm	1040	369	758	1130	-	-
Cyanide, free	0.03 ug/g	<0.03	<0.03	<0.03	<0.03	-	-
pH	0.05 pH Units	6.78	7.08	7.30	7.32	-	-

Metals

Antimony	1 ug/g	<1.0	<1.0	<1.0	<1.0	-	-
Arsenic	1 ug/g	9.9	6.6	4.5	10.4	-	-
Barium	1 ug/g	75.2	100	81.9	75.4	-	-
Beryllium	0.5 ug/g	0.8	0.6	<0.5	0.8	-	-
Boron	5 ug/g	8.7	6.9	<5.0	11.6	-	-
Boron, available	0.5 ug/g	0.7	1.0	0.9	0.6	-	-
Cadmium	0.5 ug/g	<0.5	0.6	<0.5	<0.5	-	-
Chromium (VI)	0.2 ug/g	0.2	<0.2	<0.2	<0.2	-	-
Chromium	5 ug/g	23.7	25.0	10.6	24.5	-	-
Cobalt	1 ug/g	10.8	6.9	3.8	10.7	-	-
Copper	5 ug/g	18.8	30.0	13.6	19.1	-	-
Lead	1 ug/g	11.5	28.5	13.2	11.4	-	-
Mercury	0.1 ug/g	<0.1	<0.1	<0.1	<0.1	-	-
Molybdenum	1 ug/g	1.9	1.5	1.9	2.0	-	-
Nickel	5 ug/g	30.2	20.4	11.1	29.0	-	-
Selenium	1 ug/g	<1.0	<1.0	<1.0	<1.0	-	-
Silver	0.3 ug/g	<0.3	<0.3	<0.3	<0.3	-	-
Thallium	1 ug/g	<1.0	<1.0	<1.0	<1.0	-	-

Certificate of Analysis

Report Date: 11-Nov-2022

Client: WSP E&I Canada Limited (Windsor)

Order Date: 7-Nov-2022

Client PO: OESAW2232.****.****.5120.573000

Project Description: OESAW2232.****.****.5120.573000

Client ID:	BH-SD2	BH-SD5	BH-SD8	DUP-SD3		
Sample Date:	07-Nov-22 00:00	07-Nov-22 00:00	07-Nov-22 00:00	07-Nov-22 00:00	-	-
Sample ID:	2246133-01	2246133-02	2246133-03	2246133-04		
Matrix:	Soil	Soil	Soil	Soil		
MDL/Units						

Metals

	MDL/Units	BH-SD2	BH-SD5	BH-SD8	DUP-SD3		
Uranium	1 ug/g	1.0	<1.0	<1.0	1.1	-	-
Vanadium	10 ug/g	40.4	31.4	18.6	43.7	-	-
Zinc	20 ug/g	58.4	191	54.7	58.5	-	-

Volatiles

	MDL/Units	BH-SD2	BH-SD5	BH-SD8	DUP-SD3		
Benzene	0.02 ug/g	<0.02	<0.02	<0.02	<0.02	-	-
Ethylbenzene	0.05 ug/g	<0.05	<0.05	<0.05	<0.05	-	-
Toluene	0.05 ug/g	<0.05	<0.05	<0.05	<0.05	-	-
m,p-Xylenes	0.05 ug/g	<0.05	<0.05	<0.05	<0.05	-	-
o-Xylene	0.05 ug/g	<0.05	<0.05	<0.05	<0.05	-	-
Xylenes, total	0.05 ug/g	<0.05	<0.05	<0.05	<0.05	-	-
Toluene-d8	Surrogate	91.3%	96.2%	94.2%	93.1%	-	-

Hydrocarbons

	MDL/Units	BH-SD2	BH-SD5	BH-SD8	DUP-SD3		
F1 PHCs (C6-C10)	7 ug/g	<7	<7	<7	<7	-	-
F2 PHCs (C10-C16)	4 ug/g	<4	<4	<4	<4	-	-
F3 PHCs (C16-C34)	8 ug/g	<8	134	137	16	-	-
F4 PHCs (C34-C50)	6 ug/g	<6	248	439	<6	-	-

Semi-Volatiles

	MDL/Units	BH-SD2	BH-SD5	BH-SD8	DUP-SD3		
Acenaphthene	0.02 ug/g	<0.02	<0.02	<0.02	<0.02	-	-
Acenaphthylene	0.02 ug/g	<0.02	<0.02	<0.02	<0.02	-	-
Anthracene	0.02 ug/g	<0.02	<0.02	<0.02	<0.02	-	-
Benzo [a] anthracene	0.02 ug/g	<0.02	0.03	0.04	<0.02	-	-
Benzo [a] pyrene	0.02 ug/g	<0.02	0.04	0.04	<0.02	-	-
Benzo [b] fluoranthene	0.02 ug/g	<0.02	0.04	0.04	<0.02	-	-
Benzo [g,h,i] perylene	0.02 ug/g	<0.02	0.04	0.03	<0.02	-	-
Benzo [k] fluoranthene	0.02 ug/g	<0.02	<0.02	<0.02	<0.02	-	-

Certificate of Analysis

Report Date: 11-Nov-2022

Client: **WSP E&I Canada Limited (Windsor)**

Order Date: 7-Nov-2022

Client PO: OESAW2232.****.****.5120.573000

Project Description: OESAW2232.****.****.5120.573000

Client ID:	BH-SD2	BH-SD5	BH-SD8	DUP-SD3	-	-
Sample Date:	07-Nov-22 00:00	07-Nov-22 00:00	07-Nov-22 00:00	07-Nov-22 00:00	-	-
Sample ID:	2246133-01	2246133-02	2246133-03	2246133-04	-	-
Matrix:	Soil	Soil	Soil	Soil	-	-
MDL/Units						

Semi-Volatiles

Chrysene	0.02 ug/g	<0.02	0.03	0.03	<0.02	-	-
Dibenzo [a,h] anthracene	0.02 ug/g	<0.02	<0.02	<0.02	<0.02	-	-
Fluoranthene	0.02 ug/g	<0.02	0.07	0.07	<0.02	-	-
Fluorene	0.02 ug/g	<0.02	<0.02	<0.02	<0.02	-	-
Indeno [1,2,3-cd] pyrene	0.02 ug/g	<0.02	0.04	0.04	<0.02	-	-
1-Methylnaphthalene	0.02 ug/g	<0.02	<0.02	<0.02	<0.02	-	-
2-Methylnaphthalene	0.02 ug/g	<0.02	<0.02	<0.02	<0.02	-	-
Methylnaphthalene (1&2)	0.03 ug/g	<0.03	<0.03	<0.03	<0.03	-	-
Naphthalene	0.01 ug/g	<0.01	<0.01	<0.01	<0.01	-	-
Phenanthrene	0.02 ug/g	<0.02	0.03	0.02	<0.02	-	-
Pyrene	0.02 ug/g	<0.02	0.04	0.05	<0.02	-	-
2-Fluorobiphenyl	Surrogate	62.8%	55.3%	68.3%	81.4%	-	-
Terphenyl-d14	Surrogate	73.0%	50.8%	63.5%	73.8%	-	-

Certificate of Analysis

Report Date: 11-Nov-2022

Client: WSP E&I Canada Limited (Windsor)

Order Date: 7-Nov-2022

Client PO: OESAW2232.****.****.5120.573000

Project Description: OESAW2232.****.****.5120.573000

Method Quality Control: Blank

Analyte	Result	Reporting Limit	Units	%REC	%REC Limit	RPD	RPD Limit	Notes
General Inorganics								
SAR	ND	0.01	N/A					
Conductivity	ND	5	uS/cm					
Cyanide, free	ND	0.03	ug/g					
Hydrocarbons								
F1 PHCs (C6-C10)	ND	7	ug/g					
F2 PHCs (C10-C16)	ND	4	ug/g					
F3 PHCs (C16-C34)	ND	8	ug/g					
F4 PHCs (C34-C50)	ND	6	ug/g					
Metals								
Antimony	ND	1.0	ug/g					
Arsenic	ND	1.0	ug/g					
Barium	ND	1.0	ug/g					
Beryllium	ND	0.5	ug/g					
Boron, available	ND	0.5	ug/g					
Boron	ND	5.0	ug/g					
Cadmium	ND	0.5	ug/g					
Chromium (VI)	ND	0.2	ug/g					
Chromium	ND	5.0	ug/g					
Cobalt	ND	1.0	ug/g					
Copper	ND	5.0	ug/g					
Lead	ND	1.0	ug/g					
Mercury	ND	0.1	ug/g					
Molybdenum	ND	1.0	ug/g					
Nickel	ND	5.0	ug/g					
Selenium	ND	1.0	ug/g					
Silver	ND	0.3	ug/g					
Thallium	ND	1.0	ug/g					
Uranium	ND	1.0	ug/g					
Vanadium	ND	10.0	ug/g					
Zinc	ND	20.0	ug/g					
Semi-Volatiles								
Acenaphthene	ND	0.02	ug/g					

Certificate of Analysis

Report Date: 11-Nov-2022

Client: **WSP E&I Canada Limited (Windsor)**

Order Date: 7-Nov-2022

Client PO: **OESAW2232.****.****.5120.573000**

Project Description: **OESAW2232.****.****.5120.573000**

Method Quality Control: Blank

Analyte	Result	Reporting Limit	Units	%REC	%REC Limit	RPD	RPD Limit	Notes
Acenaphthylene	ND	0.02	ug/g					
Anthracene	ND	0.02	ug/g					
Benzo [a] anthracene	ND	0.02	ug/g					
Benzo [a] pyrene	ND	0.02	ug/g					
Benzo [b] fluoranthene	ND	0.02	ug/g					
Benzo [g,h,i] perylene	ND	0.02	ug/g					
Benzo [k] fluoranthene	ND	0.02	ug/g					
Chrysene	ND	0.02	ug/g					
Dibenzo [a,h] anthracene	ND	0.02	ug/g					
Fluoranthene	ND	0.02	ug/g					
Fluorene	ND	0.02	ug/g					
Indeno [1,2,3-cd] pyrene	ND	0.02	ug/g					
1-Methylnaphthalene	ND	0.02	ug/g					
2-Methylnaphthalene	ND	0.02	ug/g					
Methylnaphthalene (1&2)	ND	0.03	ug/g					
Naphthalene	ND	0.01	ug/g					
Phenanthrene	ND	0.02	ug/g					
Pyrene	ND	0.02	ug/g					
<i>Surrogate: 2-Fluorobiphenyl</i>	<i>0.363</i>		<i>ug/g</i>	<i>72.6</i>	<i>50-140</i>			
<i>Surrogate: Terphenyl-d14</i>	<i>0.371</i>		<i>ug/g</i>	<i>74.1</i>	<i>50-140</i>			
Volatiles								
Benzene	ND	0.02	ug/g					
Ethylbenzene	ND	0.05	ug/g					
Toluene	ND	0.05	ug/g					
m,p-Xylenes	ND	0.05	ug/g					
o-Xylene	ND	0.05	ug/g					
Xylenes, total	ND	0.05	ug/g					
<i>Surrogate: Toluene-d8</i>	<i>7.37</i>		<i>ug/g</i>	<i>92.1</i>	<i>50-140</i>			

Certificate of Analysis

Report Date: 11-Nov-2022

Client: WSP E&I Canada Limited (Windsor)

Order Date: 7-Nov-2022

Client PO: OESAW2232.****.****.5120.573000

Project Description: OESAW2232.****.****.5120.573000

Method Quality Control: Duplicate

Analyte	Result	Reporting Limit	Units	Source Result	%REC	%REC Limit	RPD	RPD Limit	Notes
General Inorganics									
SAR	2.51	0.01	N/A	2.39			4.9	30	
Conductivity	1240	5	uS/cm	1230			0.4	5	
Cyanide, free	ND	0.03	ug/g	ND			NC	35	
pH	7.79	0.05	pH Units	7.79			0.0	10	
Hydrocarbons									
F1 PHCs (C6-C10)	ND	7	ug/g	ND			NC	40	
F2 PHCs (C10-C16)	ND	4	ug/g	ND			NC	30	
F3 PHCs (C16-C34)	161	8	ug/g	153			5.1	30	
F4 PHCs (C34-C50)	148	6	ug/g	189			24.3	30	
Metals									
Antimony	ND	1.0	ug/g	ND			NC	30	
Arsenic	5.9	1.0	ug/g	5.6			5.3	30	
Barium	51.9	1.0	ug/g	57.3			9.8	30	
Beryllium	0.9	0.5	ug/g	0.8			6.4	30	
Boron, available	1.68	0.5	ug/g	1.38			19.6	35	
Boron	12.5	5.0	ug/g	10.9			13.7	30	
Cadmium	ND	0.5	ug/g	ND			NC	30	
Chromium (VI)	ND	0.2	ug/g	0.2			NC	35	
Chromium	23.5	5.0	ug/g	25.1			6.5	30	
Cobalt	11.7	1.0	ug/g	12.3			5.2	30	
Copper	28.8	5.0	ug/g	30.0			4.0	30	
Lead	12.4	1.0	ug/g	12.9			4.0	30	
Mercury	ND	0.1	ug/g	ND			NC	30	
Molybdenum	3.2	1.0	ug/g	ND			NC	30	
Nickel	22.9	5.0	ug/g	24.1			5.1	30	
Selenium	2.0	1.0	ug/g	ND			NC	30	
Silver	0.4	0.3	ug/g	ND			NC	30	
Thallium	1.1	1.0	ug/g	ND			NC	30	
Uranium	ND	1.0	ug/g	ND			NC	30	
Vanadium	31.9	10.0	ug/g	35.1			9.5	30	

Certificate of Analysis

Report Date: 11-Nov-2022

Client: WSP E&I Canada Limited (Windsor)

Order Date: 7-Nov-2022

Client PO: OESAW2232.****.****.5120.573000

Project Description: OESAW2232.****.****.5120.573000

Method Quality Control: Duplicate

Analyte	Result	Reporting Limit	Units	Source Result	%REC	%REC Limit	RPD	RPD Limit	Notes
Zinc	79.7	20.0	ug/g	75.0			6.1	30	
Physical Characteristics									
% Solids	81.5	0.1	% by Wt.	82.1			0.7	25	
Semi-Volatiles									
Acenaphthene	ND	0.02	ug/g	ND			NC	40	
Acenaphthylene	ND	0.02	ug/g	ND			NC	40	
Anthracene	ND	0.02	ug/g	ND			NC	40	
Benzo [a] anthracene	ND	0.02	ug/g	ND			NC	40	
Benzo [a] pyrene	ND	0.02	ug/g	ND			NC	40	
Benzo [b] fluoranthene	ND	0.02	ug/g	ND			NC	40	
Benzo [g,h,i] perylene	ND	0.02	ug/g	ND			NC	40	
Benzo [k] fluoranthene	ND	0.02	ug/g	ND			NC	40	
Chrysene	ND	0.02	ug/g	ND			NC	40	
Dibenzo [a,h] anthracene	ND	0.02	ug/g	ND			NC	40	
Fluoranthene	ND	0.02	ug/g	ND			NC	40	
Fluorene	ND	0.02	ug/g	ND			NC	40	
Indeno [1,2,3-cd] pyrene	ND	0.02	ug/g	ND			NC	40	
1-Methylnaphthalene	ND	0.02	ug/g	ND			NC	40	
2-Methylnaphthalene	ND	0.02	ug/g	ND			NC	40	
Naphthalene	ND	0.01	ug/g	ND			NC	40	
Phenanthrene	ND	0.02	ug/g	ND			NC	40	
Pyrene	ND	0.02	ug/g	ND			NC	40	
Surrogate: 2-Fluorobiphenyl	0.346		ug/g		56.9	50-140			
Surrogate: Terphenyl-d14	0.420		ug/g		69.2	50-140			
Volatiles									
Benzene	ND	0.02	ug/g	ND			NC	50	
Ethylbenzene	ND	0.05	ug/g	ND			NC	50	
Toluene	ND	0.05	ug/g	ND			NC	50	
m,p-Xylenes	ND	0.05	ug/g	ND			NC	50	
o-Xylene	ND	0.05	ug/g	ND			NC	50	
Surrogate: Toluene-d8	8.20		ug/g		92.6	50-140			

Certificate of Analysis

Report Date: 11-Nov-2022

Client: WSP E&I Canada Limited (Windsor)

Order Date: 7-Nov-2022

Client PO: OESAW2232.****.****.5120.573000

Project Description: OESAW2232.****.****.5120.573000

Method Quality Control: Spike

Analyte	Result	Reporting Limit	Units	Source Result	%REC	%REC Limit	RPD	RPD Limit	Notes
General Inorganics									
Cyanide, free	0.887	0.03	ug/g	ND	88.7	70-130			
Hydrocarbons									
F1 PHCs (C6-C10)	60	7	ug/g	ND	84.2	80-120			
F2 PHCs (C10-C16)	87	4	ug/g	ND	93.4	60-140			
F3 PHCs (C16-C34)	378	8	ug/g	153	108	60-140			
F4 PHCs (C34-C50)	463	6	ug/g	189	182	60-140			QM-4X
Metals									
Antimony	135	1.0	ug/g	ND	108	70-130			
Arsenic	134	1.0	ug/g	5.6	103	70-130			
Barium	192	1.0	ug/g	57.3	108	70-130			
Beryllium	115	0.5	ug/g	0.8	91.3	70-130			
Boron, available	6.03	0.5	ug/g	1.38	93.0	70-122			
Boron	123	5.0	ug/g	10.9	89.6	70-130			
Cadmium	126	0.5	ug/g	ND	101	70-130			
Chromium (VI)	4.7	0.2	ug/g	0.2	74.0	70-130			
Chromium	151	5.0	ug/g	25.1	101	70-130			
Cobalt	134	1.0	ug/g	12.3	97.7	70-130			
Copper	155	5.0	ug/g	30.0	99.7	70-130			
Lead	132	1.0	ug/g	12.9	95.4	70-130			
Mercury	1.54	0.1	ug/g	ND	103	70-130			
Molybdenum	133	1.0	ug/g	ND	107	70-130			
Nickel	153	5.0	ug/g	24.1	103	70-130			
Selenium	131	1.0	ug/g	ND	105	70-130			
Silver	101	0.3	ug/g	ND	80.8	70-130			
Thallium	122	1.0	ug/g	ND	97.3	70-130			
Uranium	129	1.0	ug/g	ND	103	70-130			
Vanadium	160	10.0	ug/g	35.1	100	70-130			
Zinc	210	20.0	ug/g	75.0	108	70-130			
Semi-Volatiles									
Acenaphthene	0.461	0.02	ug/g	ND	75.8	50-140			

Certificate of Analysis

Report Date: 11-Nov-2022

Client: WSP E&I Canada Limited (Windsor)

Order Date: 7-Nov-2022

Client PO: OESAW2232.****.****.5120.573000

Project Description: OESAW2232.****.****.5120.573000

Method Quality Control: Spike

Analyte	Result	Reporting Limit	Units	Source Result	%REC	%REC Limit	RPD	RPD Limit	Notes
Acenaphthylene	0.465	0.02	ug/g	ND	76.6	50-140			
Anthracene	0.464	0.02	ug/g	ND	76.3	50-140			
Benzo [a] anthracene	0.461	0.02	ug/g	ND	75.8	50-140			
Benzo [a] pyrene	0.443	0.02	ug/g	ND	72.8	50-140			
Benzo [b] fluoranthene	0.405	0.02	ug/g	ND	66.7	50-140			
Benzo [g,h,i] perylene	0.418	0.02	ug/g	ND	68.7	50-140			
Benzo [k] fluoranthene	0.403	0.02	ug/g	ND	66.3	50-140			
Chrysene	0.418	0.02	ug/g	ND	68.8	50-140			
Dibenzo [a,h] anthracene	0.505	0.02	ug/g	ND	83.1	50-140			
Fluoranthene	0.492	0.02	ug/g	ND	80.9	50-140			
Fluorene	0.522	0.02	ug/g	ND	85.8	50-140			
Indeno [1,2,3-cd] pyrene	0.456	0.02	ug/g	ND	75.1	50-140			
1-Methylnaphthalene	0.406	0.02	ug/g	ND	66.9	50-140			
2-Methylnaphthalene	0.406	0.02	ug/g	ND	66.8	50-140			
Naphthalene	0.441	0.01	ug/g	ND	72.5	50-140			
Phenanthrene	0.453	0.02	ug/g	ND	74.5	50-140			
Pyrene	0.383	0.02	ug/g	ND	63.0	50-140			
<i>Surrogate: 2-Fluorobiphenyl</i>	<i>0.441</i>		<i>ug/g</i>		<i>72.6</i>	<i>50-140</i>			
<i>Surrogate: Terphenyl-d14</i>	<i>0.436</i>		<i>ug/g</i>		<i>71.7</i>	<i>50-140</i>			
Volatiles									
Benzene	4.20	0.02	ug/g	ND	105	60-130			
Ethylbenzene	3.89	0.05	ug/g	ND	97.4	60-130			
Toluene	4.32	0.05	ug/g	ND	108	60-130			
m,p-Xylenes	7.52	0.05	ug/g	ND	93.7	60-130			
o-Xylene	3.84	0.05	ug/g	ND	95.9	60-130			
<i>Surrogate: Toluene-d8</i>	<i>8.29</i>		<i>ug/g</i>		<i>104</i>	<i>50-140</i>			

Certificate of Analysis

Report Date: 11-Nov-2022

Client: **WSP E&I Canada Limited (Windsor)**

Order Date: 7-Nov-2022

Client PO: **OESAW2232.****.****.5120.573000**

Project Description: OESAW2232.**.****.5120.573000**

Qualifier Notes:

QC Qualifiers:

QM-4X The spike recovery was outside of QC acceptance limits due to elevated analyte concentration.

Sample Data Revisions:

None

Work Order Revisions / Comments:

None

Other Report Notes:

n/a: not applicable

ND: Not Detected

MDL: Method Detection Limit

Source Result: Data used as source for matrix and duplicate samples

%REC: Percent recovery.

RPD: Relative percent difference.

NC: Not Calculated

Soil results are reported on a dry weight basis unless otherwise noted.

Where %Solids is reported, moisture loss includes the loss of volatile hydrocarbons.

CCME PHC additional information:

- The method for the analysis of PHCs complies with the Reference Method for the CWS PHC and is validated for use in the laboratory. All prescribed quality criteria identified in the method has been met.
- F1 range corrected for BTEX.
- F2 to F3 ranges corrected for appropriate PAHs where available.
- The gravimetric heavy hydrocarbons (F4G) are not to be added to C6 to C50 hydrocarbons.
- In the case where F4 and F4G are both reported, the greater of the two results is to be used for comparison to CWS PHC criteria.
- When reported, data for F4G has been processed using a silica gel cleanup.

Any use of these results implies your agreement that our total liability in connection with this work, however arising, shall be limited to the amount paid by you for this work, and that our employees or agents shall not under any circumstances be liable to you in connection with this work.

Appendix B

Limitations



LIMITATIONS

1. The work performed in the preparation of this report and the conclusions presented are subject to the following:
 - a. The Standard Terms and Conditions which form a part of our Professional Services Contract;
 - b. The Scope of Services;
 - c. Time and Budgetary limitations as described in our Contract; and
 - d. The Limitations stated herein.
2. No other warranties or representations, either expressed or implied, are made as to the professional services provided under the terms of our Contract, or the conclusions presented.
3. The conclusions presented in this report were based, in part, on visual observations of the Site and attendant structures. Our conclusions cannot and are not extended to include those portions of the Site or structures, which are not reasonably available, in WSP's opinion, for direct observation.
4. The environmental conditions at the Site were assessed, within the limitations set out above, having due regard for applicable environmental regulations as of the date of the inspection. A review of compliance by past owners or occupants of the Site with any applicable local, provincial or federal bylaws, orders-in-council, legislative enactments and regulations was not performed.
5. The Site history research included obtaining information from third parties and employees or agents of the owner. No attempt has been made to verify the accuracy of any information provided, unless specifically noted in our report.
6. Where testing was performed, it was carried out in accordance with the terms of our contract providing for testing. Other substances, or different quantities of substances testing for, may be present on-site and may be revealed by different or other testing not provided for in our contract.
7. Because of the limitations referred to above, different environmental conditions from those stated in our report may exist. Should such different conditions be encountered, WSP must be notified in order that it may determine if modifications to the conclusions in the report are necessary.
8. The utilization of WSP's services during the implementation of any remedial measures will allow WSP to observe compliance with the conclusions and recommendations contained in the report. WSP's involvement will also allow for changes to be made as necessary to suit field conditions as they are encountered.
9. This report is for the sole use of the party to whom it is addressed unless expressly stated otherwise in the report or contract. Any use which any third party makes of the report, in whole or the part, or any reliance thereon or decisions made based on any information or conclusions in the report is the sole responsibility of such third party. WSP accepts no responsibility whatsoever for damages or loss of any nature or kind suffered by any such third party as a result of actions taken or not taken or decisions made in reliance on the report or anything set out therein.
10. This report is not to be given over to any third party for any purpose whatsoever without the written permission of WSP.
11. Provided that the report is still reliable, and less than 12 months old, WSP will issue a third-party reliance letter to parties that the client identifies in writing, upon payment of the then current fee for such letters. All third parties relying on WSP's report, by such reliance agree to be bound by our proposal and WSP's standard reliance letter. WSP's standard reliance letter indicates that in no event shall WSP be liable for any damages, howsoever arising, relating to third-party reliance on WSP's report. No reliance by any party is permitted without such agreement.